

# User manual

## Tumble dryer

**TD6–30**  
**Compass Pro**  
Type N2...



**Electrolux**  
PROFESSIONAL



# Contents

---

## Contents

1	Safety Precautions .....	5
1.1	Additional safety precautions for gas heated tumble dryer .....	7
1.2	General safety information .....	7
1.3	Commercial use only .....	7
1.4	Copyright .....	7
1.5	Symbols .....	7
2	Warranty terms and exclusions .....	8
3	Operating panel .....	9
4	Program description .....	10
4.1	General .....	10
4.2	Program description .....	11
5	Handling .....	14
5.1	Load .....	14
5.2	How to start the machine .....	15
5.3	Additional functions .....	16
5.4	When program has ended .....	17
6	Error codes .....	18
7	Maintenance .....	19
7.1	General .....	19
7.2	Time for maintenance .....	19
7.3	Every day .....	19
7.4	Machines with residual moisture control (RMC) .....	20
7.5	Maintenance to be carried out by qualified service personnel .....	20
8	Disposal information .....	21
8.1	Disposal of appliance at end of life .....	21
8.2	Disposal of packing .....	21

The manufacturer reserves the right to make changes to design and component specifications.



## 1 Safety Precautions

- Servicing shall be carried out only by authorized personnel.
- Only authorized spare parts, accessories and consumables shall be used.
- The machine is not to be used if industrial chemicals have been used for cleaning.
- Do not dry unwashed items in the machine.
- Items that have been soiled with substances such as cooking oil, acetone, alcohol, petrol, kerosene, spot removers, turpentine, waxes and wax removers should be washed in hot water with an extra amount of detergent before being dried in the machine.
- Items such as foam rubber (latex foam), shower caps, waterproof textiles, rubber backed articles and clothes or pillows fitted with foam rubber pads should not be dried in the machine.
- Fabric softeners or similar products should be used as specified by the fabric softener instructions.
- The final part of a drying cycle occurs without heat (cool down cycle) to ensure that the items are left at a temperature that ensures that the items will not be damaged.
- Remove all objects from pockets such as lighters and matches.
- **WARNING.** Never stop the machine before the end of the drying cycle unless all items are quickly removed and spread out so that the heat is dissipated.
- Adequate ventilation has to be provided to avoid the back flow of gases into the room for appliances burning other fuels, including open fires.
- Exhaust air must not be discharged into a flue which is used for exhausting fumes from appliances burning gas or other fuels.
- The machine must not be installed behind a lockable door, a sliding door or a door with a hinge on the opposite side to that of the machine in such a way that a full opening of the machine is restricted.
- If the machine has a lint trap this has to be cleaned frequently.
- The lint must not be accumulated around the machine.
- **DO NOT MODIFY THIS APPLIANCE.**
- When performing service or replacing parts, the power must be disconnected.
- When the power is disconnected, the operator must see that the machine is disconnected (that the plug is removed and remains removed) from any point to which he has access. If this is not possible, due to the construction or installation of the machine, a disconnection with a locking system in the isolated position shall be provided.
- In accordance with the wiring rules: mount a multi-pole switch prior to the machine to facilitate installation and service operations.
- **WARNING:** The appliance must not be supplied through an external switching device, such as a timer, or connected to a circuit that is regularly switched on and off by a utility.
- If different rated voltages or different rated frequencies (separated by a /) are stated at the machine data plate, instructions for adjusting the appliance for operation at the required rated voltage or rated frequency are stated in the installation manual.
- Stationary appliances not fitted with means for disconnection from the supply mains having a contact separation in all poles that provide full disconnection under overvoltage category III, the instructions state that means for disconnection must be incorporated in the fixed wiring in accordance with the wiring rules.
- The openings in the base, shall not be obstructed by a carpet.

- Oil-affected items can ignite spontaneously, especially when exposed to heat sources such as in a tumble dryer. The items become warm, causing an oxidation reaction in the oil. Oxidation creates heat. If the heat cannot escape, the items can become hot enough to catch fire. Piling, stacking or storing oil-affected items can prevent heat from escaping and so create a fire hazard.
- If it is unavoidable that fabrics that contain vegetable or cooking oil or have been contaminated by hair care products be placed in a tumble dryer they should first be washed in hot water with extra detergent – this will reduce, but not eliminate, the hazard.
- Maximum mass of dry cloth: 30.5 kg.
- A-weighted emission sound pressure level at working stations: 70 dB(A).
- Additional requirements for the following countries; AT, BE, BG, HR, CY, CZ, DK, EE, FI, FR, DE, GR, HU, IS, IE, IT, LV, LT, LU, MT, NL, NO, PL, PT, RO, SK, SI, ES, SE, CH, TR, UK:
  - The appliance can be used in public areas.
  - This appliance can be used by children aged from 8 years and above and persons with reduced physical, sensory or mental capabilities or lack of experience and knowledge if they have been given supervision or instruction concerning use of the appliance in a safe way and understand the hazards involved. Children shall not play with the appliance. Cleaning and user maintenance shall not be made by children without supervision.
- Additional requirements for other countries:
  - This appliance is not intended for use by persons (including children) with reduced physical, sensory or mental capabilities, or lack of experience and knowledge, unless they have been given supervision or instruction concerning use of the appliance by a person responsible for their safety. Children should be supervised to ensure that they do not play with the appliance.

**1.1 Additional safety precautions for gas heated tumble dryer**

- Before installation, check that the local distribution conditions, nature of gas and pressure and the adjustment of the appliance are compatible.
- The machine is not to be installed in rooms containing cleaning machines with perchloroethylene, TRICHLOROETHYLENE or CHLOROFLUOROCONTAINING HYDROCARBONS as cleaning agents.
- NOTE: it is pointed out that the connection and commissioning of appliances complying with this standard are subject to observance of the installation regulations in force in the countries where these appliances are marketed.
- Connection to the appliance shall be made with a flexible hose suitable for the appliance category in accordance with national installation regulations of the country of destination and that in case of doubt the installer shall contact the supplier.
- The appliance should be installed on non-flammable materials for the floor, worktop and/or wall close to the appliance if required.
- If you can smell gas:
  - Do not switch on any equipment
  - Do not use electrical switches
  - Do not use telephones in the building
  - Evacuate the room, building or area
  - Contact the person responsible for the machine

**1.2 General safety information**

In order to prevent damage to the electronics (and other parts) that may occur as the result of condensation, the machine should be placed in room temperature for 24 hours before being used for the first time.





**1.3 Commercial use only**

The machine/machines covered by this manual is/are made for commercial and industrial use only.

**1.4 Copyright**

This manual is intended solely for consultation by the operator and can only be given to third parties with the permission of Electrolux Professional company.

**1.5 Symbols**

	Caution
	Caution, hot surface
	Caution, high voltage
	Read the instructions before using the machine

## 2 Warranty terms and exclusions

If the purchase of this product includes warranty coverage, warranty is provided in line with local regulations and subject to the product being installed and used for the purposes as designed, and as described within the appropriate equipment documentation.

Warranty will be applicable where the customer has used only genuine spare parts and has performed maintenance in accordance with Electrolux Professional user and maintenance documentation made available in paper or electronic format.

Electrolux Professional strongly recommends using Electrolux Professional approved cleaning, rinse and descaling agents to obtain optimal results and maintain product efficiency over time.

The Electrolux Professional warranty does not cover:

- service trips cost to deliver and pick up the product;
- installation;
- training on how to use/operate;
- replacement (and/or supply) of wear and tear parts unless resulting from defects in materials or workmanship reported within one (1) week from the failure;
- correction of external wiring;
- correction of unauthorized repairs as well as any damages, failures and inefficiencies caused by and/or resulting from:
  - insufficient and/or abnormal capacity of the electrical systems (current/voltage/frequency, including spikes and/or outages);
  - inadequate or interrupted water supply, steam, air, gas (including impurities and/or other that does not comply with the technical requirements for each appliance);
  - plumbing parts, components or consumable cleaning products that are not approved by the manufacturer;
  - customer's negligence, misuse, abuse and/or non-compliance with the use and care instructions detailed within the appropriate equipment documentation;
  - improper or poor: installation, repair, maintenance (including tampering, modifications and repairs carried out by third parties not authorized third parties) and modification of safety systems;
  - Use of non-original components (e.g.: consumables, wear and tear, or spare parts);
  - environment conditions provoking thermal (e.g. overheating/freezing) or chemical (e.g. corrosion/oxidation) stress;
  - foreign objects placed in- or connected to- the product;
  - accidents or force majeure;
  - transportation and handling, including scratches, dents, chips, and/or other damage to the finish of the product, unless such damage results from defects in materials or workmanship and is reported within one (1) week of delivery unless otherwise agreed;
- product with original serial numbers that have been removed, altered or cannot be readily determined;
- replacement of light bulbs, filters or any consumable parts;
- any accessories and software not approved or specified by Electrolux Professional.

Warranty does not include scheduled maintenance activities (including the parts required for it) or the supply of cleaning agents unless specifically covered within any local agreement, subject to local terms and conditions.

Check on Electrolux Professional website the list of authorized customer care.



### 3 Operating panel

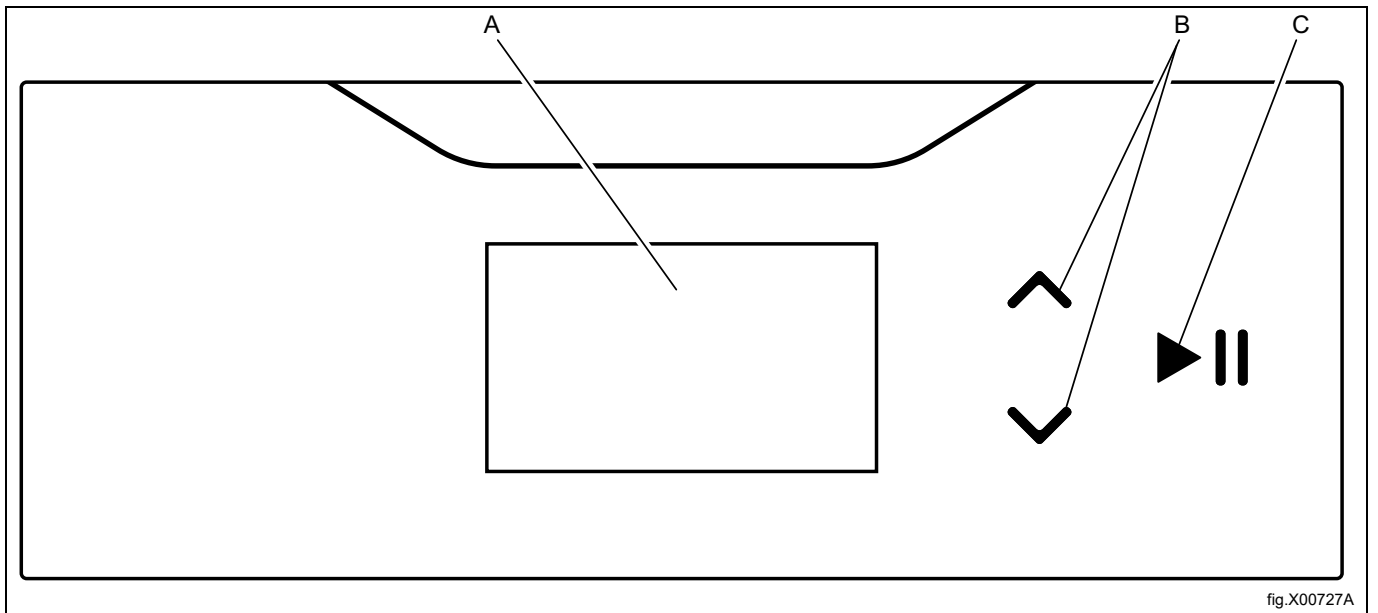

A	Display
B	Up- and down arrows that are used to scroll up and down through the menus on the display.
C	Start- and pause button

## **4 Program description**

### **4.1 General**

The machine is equipped with a number of programs adapted to the range of use to which the machine is intended — different markets use different programs. The following program description is a short description of some examples of programs that can be used.

For best possible drying result it is advisable to dry garments of the same quality for each drying cycle.

## 4.2 Program description

There are two types of programs, automatic programs and time programs.

- Automatic programs has moisture detection and will stop when selected dryness is achieved.
- Time programs has no moisture detection and will stop when the preset or selected time has ended.







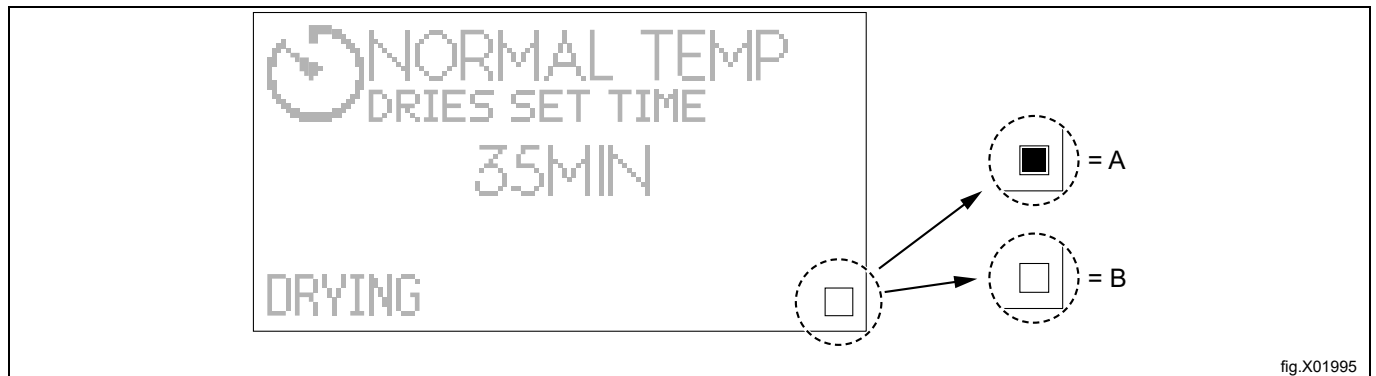





















During a drying cycle, when the square in the lower right corner is fully ticked, it indicates that the heating unit is active / ON. The heating unit can be gas, electric, steam or heat pump type.



If the square box is not ticked, it doesn't mean the heating unit is abnormal. This box is just monitoring the status of the heating unit and shows if it is Active / ON or Inactive / OFF.

- A = Active / ON
- B = Inactive / OFF









## Automatic programs

Program name and display symbol	Care label	Program description
NORMAL TEMP EXTRA DRY 	 	Normal temperature. The program will stop automatically when the garments are extra dry.
LOW TEMP EXTRA DRY 		Low temperature. The program will stop automatically when the garments are extra dry.
NORMAL TEMP DRY 	 	Normal temperature. The program will stop automatically when the garments are dry.
LOW TEMP DRY 		Low temperature. The program will stop automatically when the garments are dry.
NORMAL TEMP IRON DRY 	 	Normal temperature. The program will stop when the garments still are a bit damp.
LOW TEMP IRON DRY 		Low temperature. The program will stop when the garments still are a bit damp.
LOW TEMP DOWN 		Low temperature. The drying time has to be adjusted according to garment type to achieve the desired dryness. This program is suitable when drying for example duvet jacket, duvet quilt, duvet pillow.
LOW TEMP SENSITIVE 		Low temperature. This program is suitable when drying for example man made fiber textiles like polyester, polyamide, natural fiber textiles (silk textiles).
WOOL 	 	Normal temperature. The program will stop before the garments are totally dry — which protects the garments. This very gentle program is suitable when drying for example woolen garments of more or less all types. For example blankets, jackets etc.
LOW TEMP MOPS 		Low temperature. The program will stop when the mops are dry. This program is suitable when drying for example synthetic microfibre mops.
LOW TEMP CLOTHS 		Low temperature. The program will stop when the cloths are dry. This program is suitable when drying for example synthetic microfibre cloths.
GLOBAL DISINFECTION 		Normal temperature. The program will stop when disinfection procedure criteria is fulfilled. Global Disinfection program are only available on electric- and gas heated machines. Max half load, load factor 1:44 Do not stop the drying process prematurely. Check that there are no moist areas in the load after finished drying process. Avoid entanglement of loaded items during drying process. To achieve disinfection of the laundry, in Electrolux Professional washing machines, it is necessary to use Global Disinfection programs during drying.

Program name and display symbol	Care label	Program description
NORMAL TEMP LARGE TEXTILES	 	Normal temperature. The program will stop automatically when the fabric is dry. This program is suitable when drying large fabrics such as bed sheets, table cloths, curtains ect. The program is built to prevent the fabric from tangling together.
LOW TEMP LARGE TEXTILES		Low temperature. The program will stop automatically when the fabric is dry. This program is suitable when drying large fabrics such as bed sheets, table cloths, curtains ect. The program is built to prevent the fabric from tangling together.

**Time programs**

Program name and display symbol	Care label	Program description
NORMAL TEMP DRIES SET TIME 	 	Normal temperature. Different drying times can be selected. The program will stop when the time is up.
LOW TEMP DRIES SET TIME 		Low temperature. Different drying times can be selected. The program will stop when the time is up.
AIRING DRIES SET TIME 		Without heat. Different drying times can be selected. The program will stop when the time is up.

- Programs with NORMAL TEMP are suitable for most textiles.
- Programs with LOW TEMP should be used for synthetic textiles e.g. polyester, polyamide, polyacrylic and elasthan, viscose, polycotton and delicate fabrics marked with the symbol (in the following figure) or with the text "Tumble dry low" or similar.

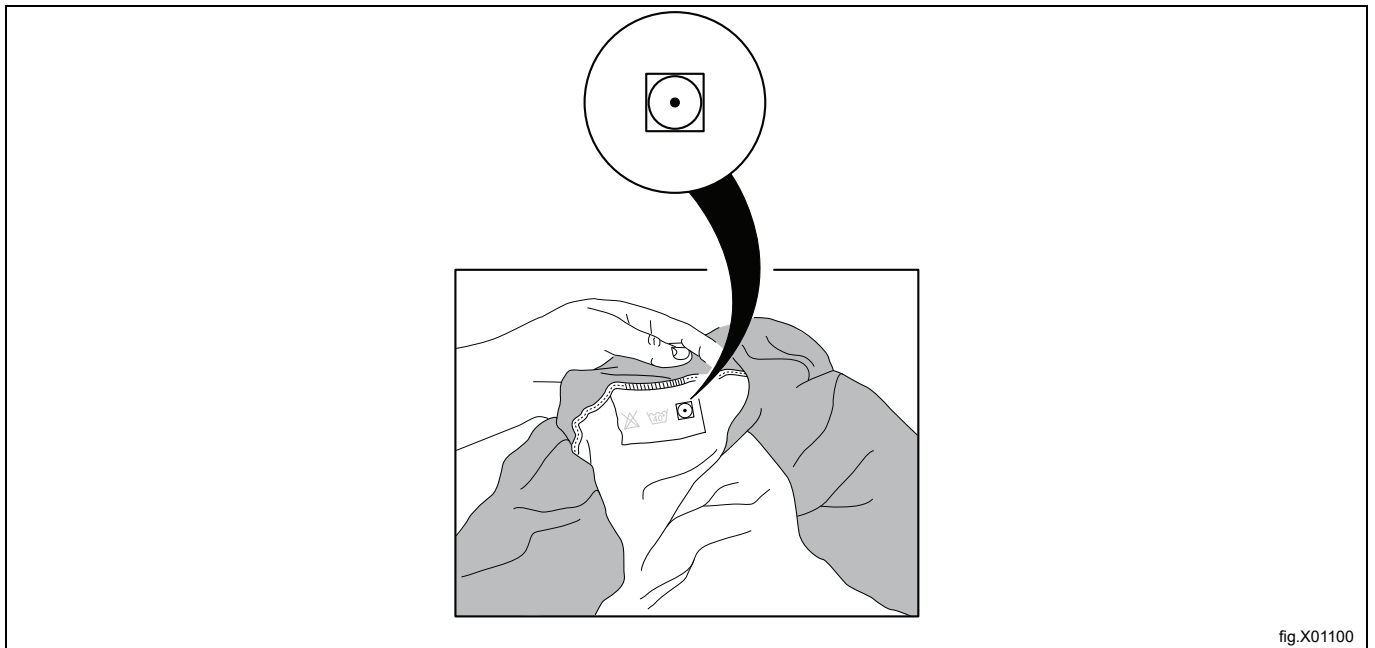

fig.X01100

## 5 Handling

### 5.1 Load

**Note!**

Remove all objects from pockets and make sure there are no metal objects such as screws, pins etc. left. Metal objects might cause damage to the drum.

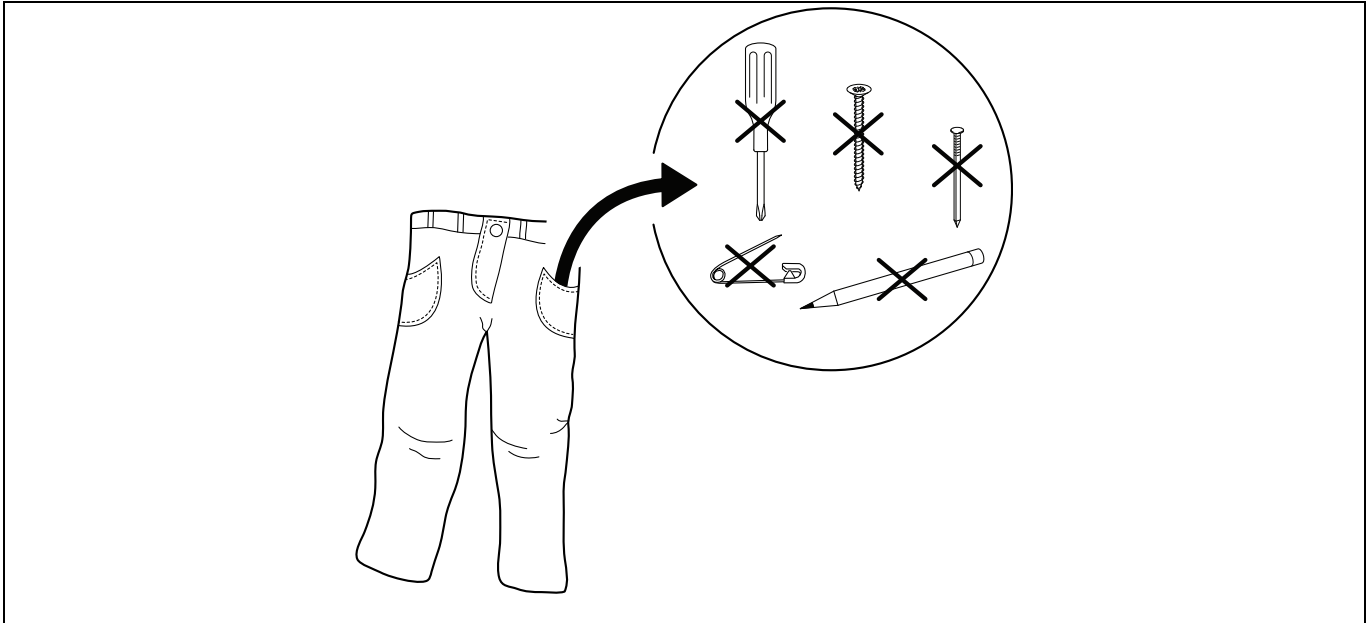

Load the goods into the machine according to recommendations and close the door.

Make sure the filter is clean and clean if necessary.

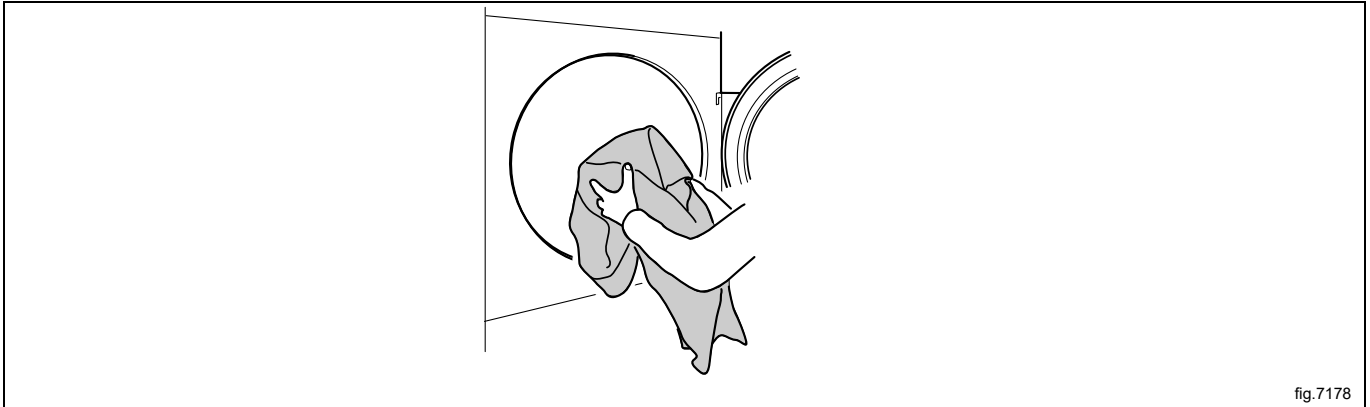

fig.7178

The recommended maximum load is 37.5 kg.

## 5.2 How to start the machine

### Automatic programs

Select program with the up- and down arrows.

Start the machine by pressing ▶|| .

### Time programs

Select program with the up- and down arrows.

Start the machine by pressing ▶|| .

After start it is possible to change the time for the selected program:

- Increase or decrease the time with the up- and down arrows,  
    ^ increases the time and v decreases the time.
- Press ▶|| to start again.

### Coin operated machines

Insert correct amount of coins to start the machine and/or press ▶|| .

After start it is possible to add time for the selected program. Insert more coins to add time.

### 5.3 Additional functions

There is a menu with additional functions available for selection after start. When pressing ►|| the menu will appear on the display.

Select from the menu with the up- and down arrows and press ►|| to activate.

#### **Note!**

**Some of the functions may not be available or active on your machine.**

#### **Pause**

It is possible to pause an ongoing program.

Select PAUSE and activate.

For some machines it is also possible to pause directly when pressing ►|| .

When pressing ►|| again the program will continue.

#### **End a program**

It is possible to end a program after start.

Select END PROGRAM and activate.

When pressing ►|| the program will be ended.

#### **Status**

Select STATUS MENU and activate.

The status menu shows the status for inlet air temp, outlet air temp, RMC and if the heat is on or off in the machine.



## 5.4 When program has ended

### Note!

For the best possible drying result it is important to empty the machine as soon as the program has ended.

If the machine is not emptied as soon as the program has ended the drum will rotate in short intervals in order to keep the goods from being wrinkled.

Clean the filter after each drying cycle for best performance.

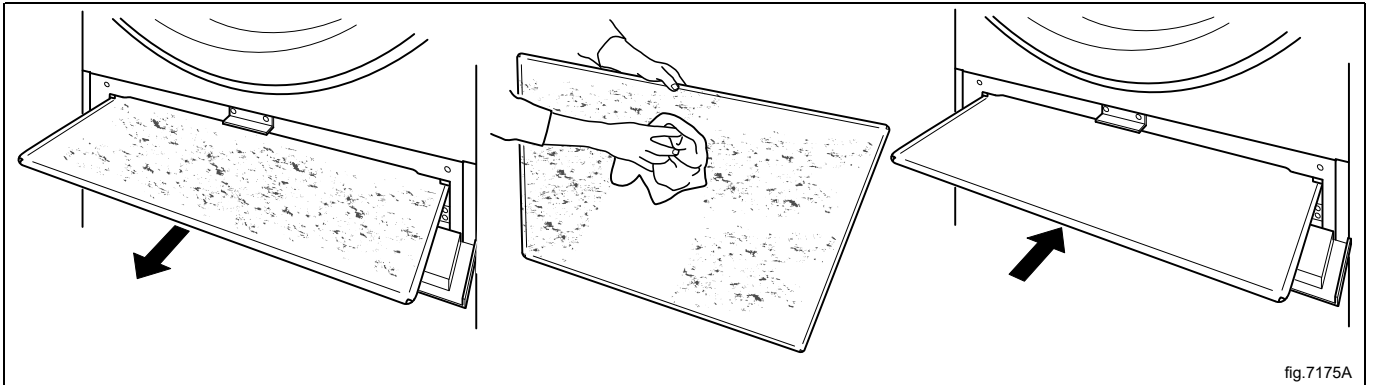

## 6 Error codes

A fault in the program or in the machine is indicated by an error code on the display.  
Some of these error codes can be solved easily without contacting service personnel.

Error code	Text	Cause/Action
12:11	DRYING ERROR WITH RMC PROGRAM	The longest permitted RMC time has been exceeded. (Applies only to machines with RMC). The machine is overfilled or the garment is too wet.
12:12	DRYING ERROR WITH AUTOSTOP PROGRAM	The longest permitted automatic stop time has been exceeded. (Applies only to machines with automatic stop). The machine is overfilled or the garment is too wet.
12:14	GAS ERROR PRESS GAS RESET BUTTON	No flame has been detected. (Applies only to gas heated machines). Reset by pressing ►   until the error code text disappears. On Coin operated machines: Reset by pressing the service button.
12:15	NO VACUUM	The machine is overfilled or the garment is too wet. Unload some of the garment and try to start again.
12:16	VACUUM SWITCH SHORTED	The vacuum/pressure switch does not close within the set time. Open and close the door and try to start again.
12:18	REDISTRIBUTION OF LOAD NEEDED	Machine indicates that load is blocking the airflow. Redistribute the load. Restart the machine to clear error message.
20:1	O. H. DRUM MOTOR	The motor is too hot. The machine will restart automatically when the temperature on the motor is OK (if the door has not been opened).
30:1	O. H. FAN MOTOR	The motor is too hot. The machine will restart automatically when the temperature on the motor is OK (if the door has not been opened).

For other error codes or repeated error codes, disconnect the power for 30 seconds. If the error code keeps coming back, contact authorized service personnel.

## 7 Maintenance

### 7.1 General

It is the responsibility of the owner of the machine/the laundry manager to make sure that maintenance is periodically performed.

#### **Note!**

**Lack of maintenance may deteriorate the performance of the machine and may cause damage to components.**

### 7.2 Time for maintenance

When the display is showing the message `TIME FOR MAINTENANCE` — contact the owner of the machine/the laundry manager to perform maintenance (if available, a telephone number and/or a tag will also be displayed).

The machine can be used meanwhile. However, the message will keep coming back until the service is performed.

The message will disappear after about 30 seconds or if **▶||** is pressed.

### 7.3 Every day

Check that the machine does not operate with the door open, if so, the machine must be placed out of order until repairs are made.

#### **Note!**

**Contact qualified service personnel to disconnect power from the affected machine.**

Clean the door, door glass, door gasket and other external parts.

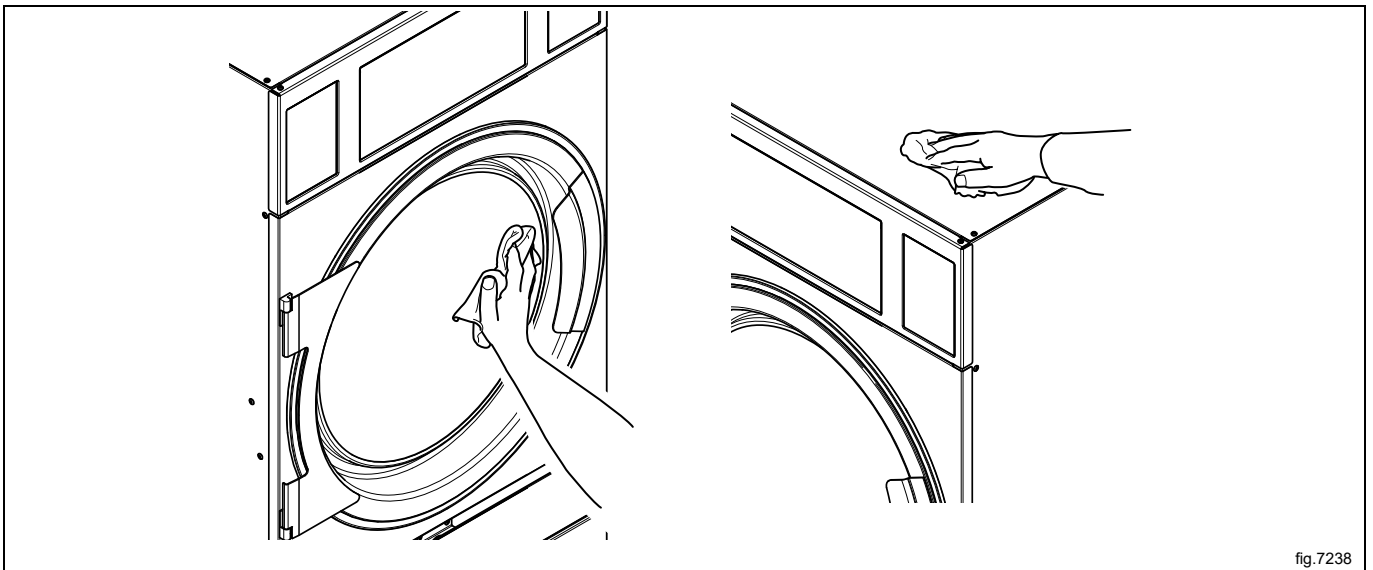

Check that the filter is clean and unbroken. Clean or replace if necessary.

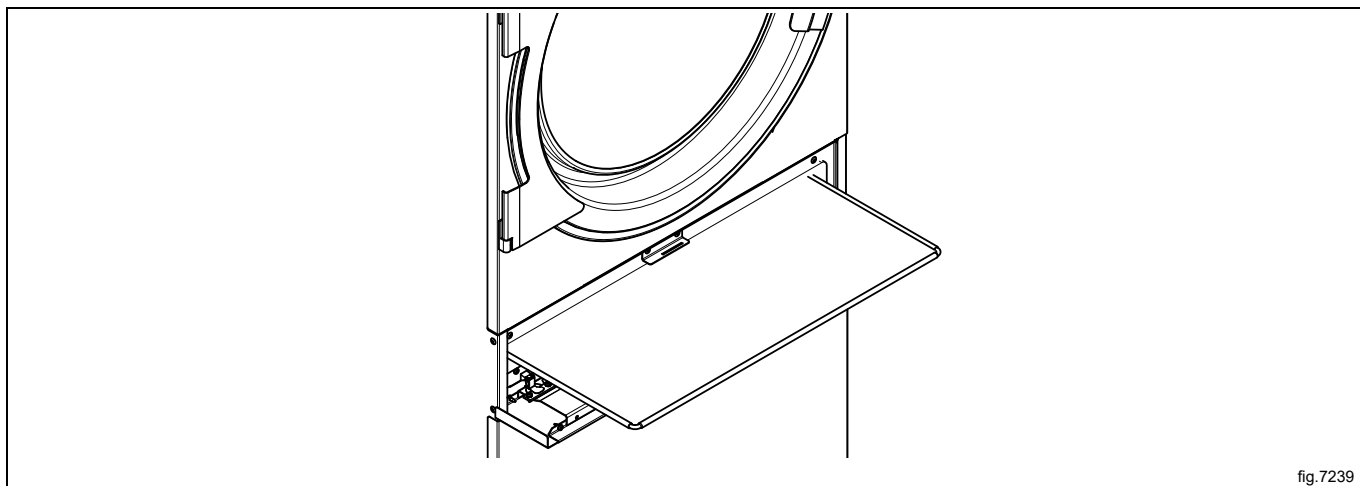

Remove any lint and dust around the machine.



#### 7.4 Machines with residual moisture control (RMC)

At regular basis, wipe off/clean drum and lifters with citric acid (*Acidum citricum*). If soap/softener residue remains, it is recommended also to use a coarse sponge.

Lack of cleaning can affect the functionality of the residual moisture control. This can result in more moist load than requested at program end.

#### 7.5 Maintenance to be carried out by qualified service personnel

Contact qualified service personnel to perform the following maintenance:

After 1600 hours of operation or once a year, whichever comes first:

- Clean the fan, the exhaust duct and the fresh-air intake to the room
- On machines with RMC: Clean the glide surface on the RMC graphite collector
- Clean the area around the drum
- Clean the motors
- Check the belt tension

For original spareparts please contact your local authorized dealer.

## 8 Disposal information

### 8.1 Disposal of appliance at end of life

Before disposing of the machine, make sure to carefully check its physical condition, and in particular any parts of the structure that can give or break during scrapping.

The machine's parts must be disposed of in a differentiated way, according to their different characteristics (e.g. metals, oils, greases, plastic, rubber, etc.).

Different regulations are in force in the various countries, therefore comply with the provisions of the laws and competent bodies in the country where scrapping takes place.

In general, the appliance must be taken to a specialised collection/scrapping centre.

Dismantle the appliance, grouping the components according to their chemical characteristics, remembering that the compressor contains lubricant oil and refrigerant fluid which can be recycled, and that the refrigerator and heat pump components are special waste assimilable with urban waste.

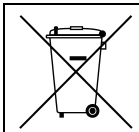

The symbol on the product indicates that this product should not be treated as domestic waste, but must be correctly disposed of in order to prevent any negative consequences for the environment and human health. For further information on the recycling of this product, contact the local dealer or agent, the Customer Care service or the local body responsible for waste disposal.



#### Note!

**When scrapping the machine, any marking, this manual and other documents concerning the appliance must be destroyed.**

### 8.2 Disposal of packing

The packing must be disposed of in compliance with the current regulations in the country where the appliance is used. All the packing materials are environmentally friendly.

They can be safely kept, recycled or burned in an appropriate waste incineration plant. Recyclable plastic parts are marked as following examples.

 <p>PE</p>	<p>Polyethylene:</p> <ul style="list-style-type: none"> <li>• Outer wrapping</li> <li>• Instructions bag</li> </ul>
 <p>PP</p>	<p>Polypropylene:</p> <ul style="list-style-type: none"> <li>• Straps</li> </ul>
 <p>PS</p>	<p>Polystyrene foam:</p> <ul style="list-style-type: none"> <li>• Corner protectors</li> </ul>







Electrolux Professional AB  
341 80 Ljungby, Sweden  
[www.electroluxprofessional.com](http://www.electroluxprofessional.com)