

# K-Soft/Karma Gravity Version

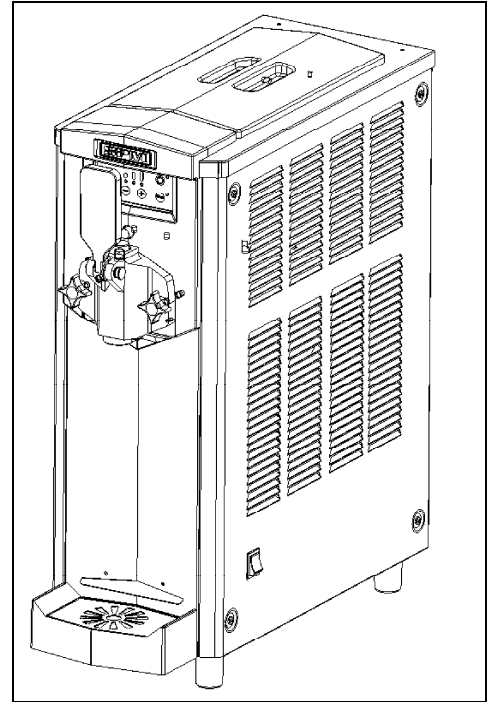

Operator's manual

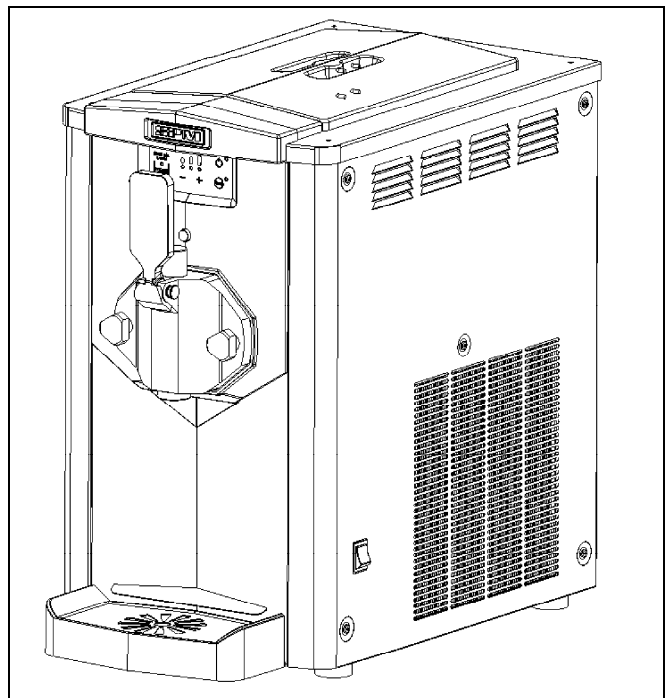

All reproduction rights of this manual are reserved to **Electrolux Professional SPA**. Reproduction, even partial, is prohibited.

Descriptions and illustrations relate to the specific machine/equipment in question. **Electrolux Professional SPA** reserves the right to introduce appropriate modifications to the machine/equipment in production at any time.

This manual:

is an integral part of the supply and must be read carefully in order that the machine is properly used, in compliance with essential safety requirements

has been drafted in accordance with the provisions of **Machinery Directive 2006/42/EC** and provides the technical information necessary to properly perform all procedures in conditions of safety

must be carefully preserved (protected in a transparent and waterproof cover to avoid deterioration) and must accompany the machine throughout its life, including any changes of ownership. In case of loss or damage, it is possible to request a copy from **Electrolux Professional SPA**, reporting the data shown on the identification plate

**Electrolux Professional SPA** declines any responsibility for improper use of the machine/equipment and/or for damage caused by operations not provided for in this manual.

## TABLE OF CONTENTS

1. SAFETY INSTRUCTIONS.....	4
Cleaning and daily sanitizing procedures .....	5
2. SUPPLIED WITH THE APPLIANCE.....	13
3. ADVICE FOR TRANSPORT .....	13
4. ADVICE FOR LIFTING .....	13
5. TECHNICAL SPECIFICATIONS .....	13
6. POSITIONING .....	15
7. CONNECTING TO MAINS POWER SUPPLY .....	16
8. START-UP PROCEDURES AND METHOD OF USE.....	17
9. EXTRAORDINARY MAINTENANCE.....	20
Cleaning the condenser filter (only for KSoft)	20
Checking and replacing the seals .....	21
Winter storage .....	21
Product storage.....	21
10. USEFUL INFORMATION ON ICE CREAM MIXES .....	22
11. DISCLAIMER .....	22
12. TROUBLESHOOTING GUIDE .....	23
13. WIRING DIAGRAM.....	25

## 1. SAFETY INSTRUCTIONS

**T**his installation and operation manual is an integral part of the equipment and must be kept for future consultation.

**U**nless otherwise stated, this manual is addressed to operators (staff members who uses the equipment on a daily basis) and to servicemen (staff members qualified to carry out the installation and/or

maintenance). **T**he parts of the manual addressed only to servicemen are pointed out accordingly. **P**lease read carefully the warnings listed here below before installation and start-up of the equipment.

**T**his equipment has been designed to produce soft serve ice cream, ice milk, frozen yogurt, smoothies and similar frozen dairy products obtained by blending water or milk with the powder.

**U**pon receipt of the equipment, make sure that its part number matches the one specified in the order, which can be found on all the delivery documents.

**T**his equipment is exclusively destined to the purpose for which it was designed.

**T**he manufacturer cannot be held responsible for any damage due to improper use.

**T**his appliance can be used by children aged from 8 years and above and persons with reduced physical, sensory or mental capabilities or lack of experience and knowledge if they have been given supervision or instruction concerning use of the appliance in a safe way and understand the hazards involved. **C**hildren shall not play with the appliance. **C**leaning and user maintenance shall not be made by children without supervision.

**T**his equipment is not suitable for outdoor use. This machine is not suitable for installation in locations where water jets are used and it must not be cleaned by a water jet.

**T**he appliance is only to be installed in locations where it can be overseen by trained personnel.

**D**o not store explosive substances such as aerosol cans with a flammable propellant in this appliance.

**T**his appliance is intended to be used in household and similar applications such as – staff kitchen areas in shops, offices and other working environments;  
– farm houses and by clients in hotels, motels and other residential type environments;  
– bed and breakfast type environments;  
– catering and similar non-retail applications.

**T**he installation and subsequent servicing operations must be carried out by skilled members who have been trained to use the device and in compliance with the regulations in force.

**T**he machine has to be placed on a sturdy, horizontal surface making sure it is well ventilated by leaving a gap of 20 cm around it and do not install it near heat sources (fig.1); we recommend you to maintain a room temperature between 24 and 32°C.

**F**or a safe and correct installation, it is essential to provide a suitable socket controlled by a thermal cut-out switch whose contacts are at least 3 mm apart, in accordance with the current national safety regulations.

**I**f the power cable is damaged, it must be replaced by the manufacturer, its after sale service or by qualified personnel, to prevent any possible risk.

- **WARNING:** do not locate multiple portable socket-outlets or portable power supplies at the rear of the appliance.

- **WARNING:** when positioning the appliance, endure the supply cord is not trapped or damaged.

The continuous, equivalent, weighted level of acoustic pressure is below 70 dB.

**This manual is also available in an alternative format on our website.**

### ***Cleaning and daily sanitizing procedures***

In order to maintain your machine in like-new operating condition and to respect current regulations, it's absolutely necessary to frequently and carefully perform the cleaning and sanitizing operations as described below.

In case of prolonged shutdown (winter storage), the machine must be disassembled, washed and sanitized according to the instructions in this manual before start-up to ensure the best possible cleanliness.

### **!Caution!**

**Electric shock hazard. Do not splash water on switches or allow water to flow onto electrical components inside the machine.**

### **!Caution!**

**To prevent bacteria growth, use only sanitizers approved for plastic and rubber objects, failure to do so could create a health hazard.**

**Note:** it is responsibility of the operator to be aware of and conform to the requirements of current local, state and federal laws concerning the frequency of cleaning and conservation of products used.

The cleaning instructions explained in this section are essential procedures to remove bacteria and maintain a sanitarily clean machine.

***We recommend to replace the product every day and to perform the cleaning and sanitizing procedures daily and anyway according to the local laws.***

The machine and the mix manufacturers decline all responsibility to damage that directly or indirectly derives from people, animals, as consequence of failure to comply with all cleaning and sanitation instructions indicated in this manual.

- **S**witch off the cooling system by pushing power button B.
- **A**ctivate cleaning mode pushing the corresponding button C.
- **R**emove the cover from the upper tank.
- **F**ill the upper tank with lukewarm water and rinse the machine (fig.1) in order to flush it to remove the major part of the product residuals.
- **R**epeat this operation until exiting water is clear.
- **B**ring **S**odium hypochlorite 2% sanitizer/cleaner.

**!IMPORTANT!**

**The type and concentration of sanitizing agent shall comply with 40 CFR §180.940**

**Carefully follow the instructions of the sanitizer manufacturer with regard to timing and method of use.**

- **T**urn off the main switch A on the right side of the appliance and disconnect the power lead from the mains.
- **W**ash and disinfect hands thoroughly before performing cleaning operations otherwise use clean and sanitized gloves.
- **F**ill the top tank with hot water (fig. 2) and wait a few minutes.
- **E**mpy the cylinder and repeat the same steps until the water coming out is clear (fig. 3).

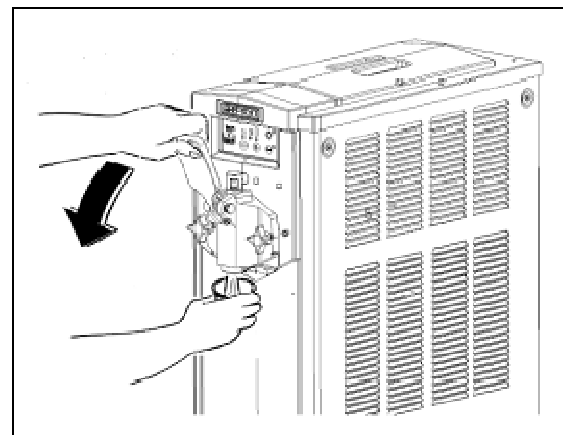

**Fig. 1**

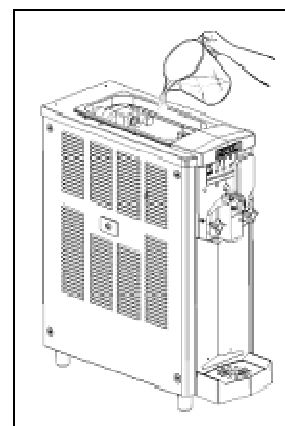

**Fig. 2**

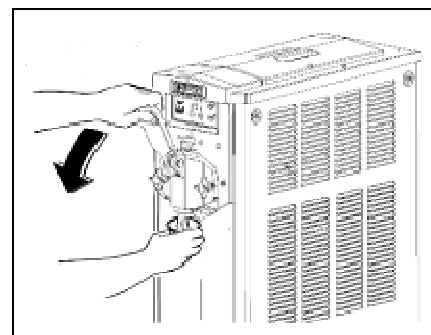

**Fig. 3**

## **!Attention!**

**T**o avoid risk of electrical shock or contact with moving parts during dismantling and reassembly, make sure all switches are in the off position and that the power lead is disconnected from the mains.

- **U**nscrew the security knobs and remove the front flange (fig. 4 and 5).

- **D**ismantle the tap from the flange by removing the fixing pin (fig. 6) so that you can remove the lever and its spring and release the piston from its housing (fig. 7).

## **!Attention!**

**T**o prevent the formation of bacteria always remove and clean the piston o-ring seals. **F**ailure to comply with this requirement poses a health hazard.

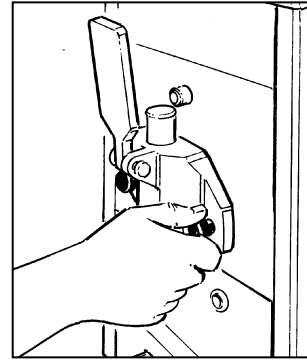

**Fig. 4**

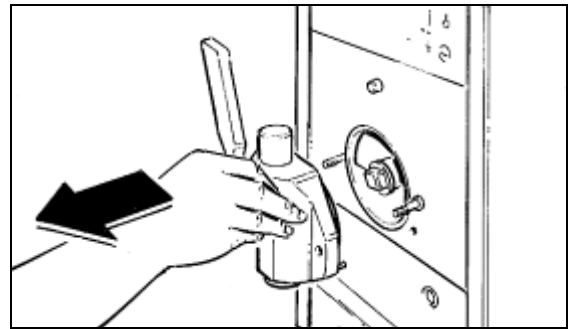

**Fig. 5**

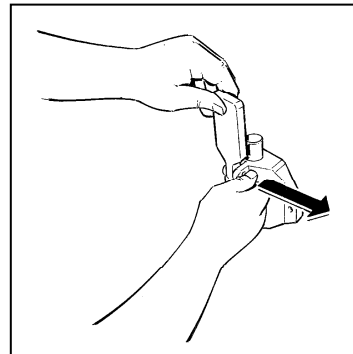

**Fig. 6**

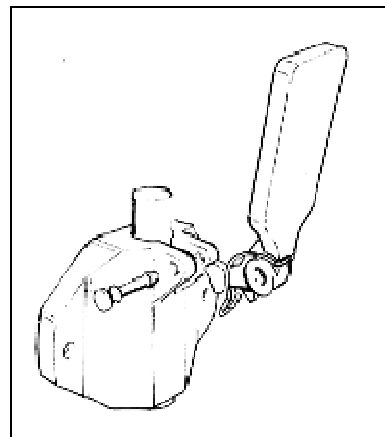

**Fig. 7**

- **R**emove the device that gives the star-shaped form to the ice cream from the flange (fig. 9).

- **R**emove the auger (fig.8)

- **R**emove the rear seal (fig.10) and clean it carefully with the provided brush in order to remove any food residues that may be present (fig.11).

- **W**ash both the parts carefully with hot water the mild dish detergent taking.

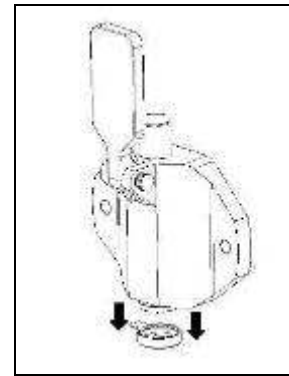

**Fig. 9**

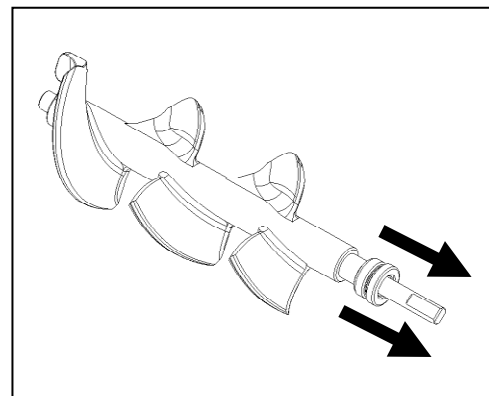

**Fig. 10**

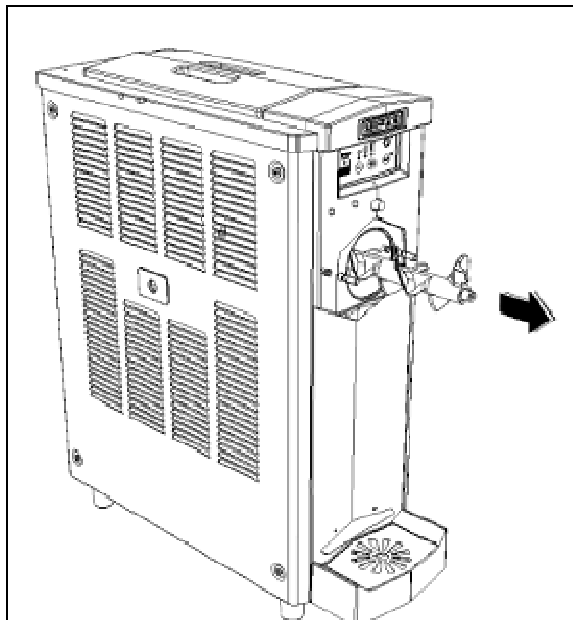

**Fig. 8**

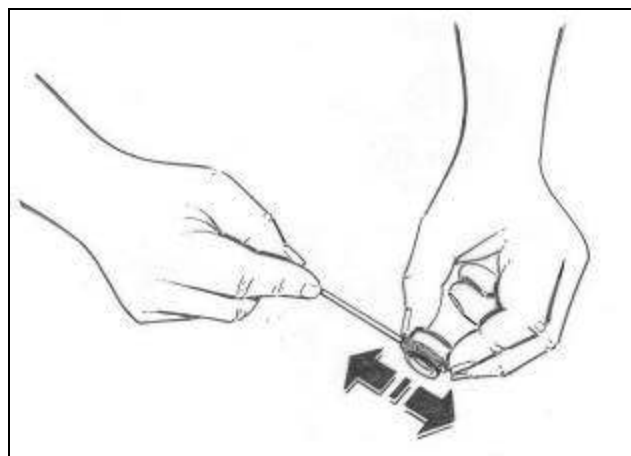

**Fig. 11**



- **R**emove all components inside the top tank as shown in fig. 12:

G – floating product level;  
E – mixing impeller.

- **W**ash each of these components thoroughly with hot water and washing-up liquid.

- **R**emove the drip tray by pulling it gently outwards (fig. 13) and wash it thoroughly with hot water and washing-up liquid.

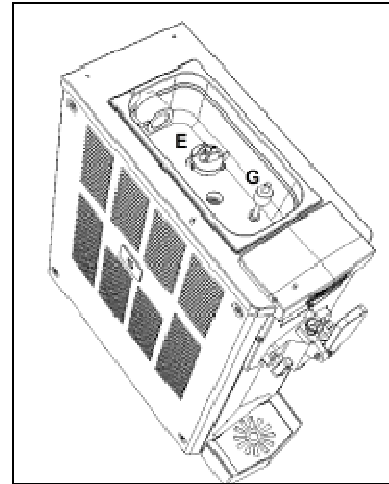

**Fig. 12**

## **ATTENTION**

**N**ever carry out washing operations in a dishwasher as these components may be severely damaged in it.

- **R**inse well and dip each piece in the sanitising product according to the doses and immersion times suggested by its manufacturer (**S**odium hypochlorite 2% 15 minutes).

- **O**nce the correct times for sanitising have been followed, remove and dry all components on a clean surface. **D**o not rinse.

- **W**ash the freezing cylinder and top tank thoroughly, removing any remaining product with a clean sponge soaked with the sanitizing solution making sure to completely wet all surfaces for at least 60 seconds. **L**et air dry.

**F**ollow local health ordinances (see figure 14).

- **S**pray sanitizer on all these surfaces leaving it as suggested by the manufacturer (see fig. 14).

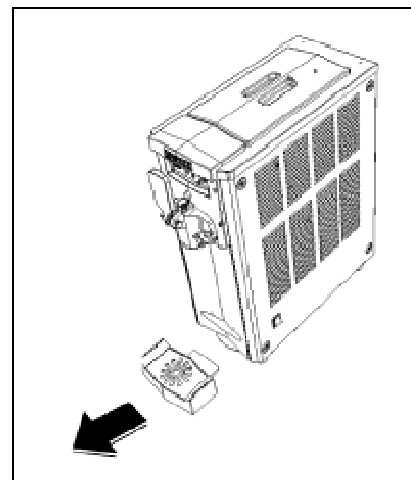

**Fig. 13**

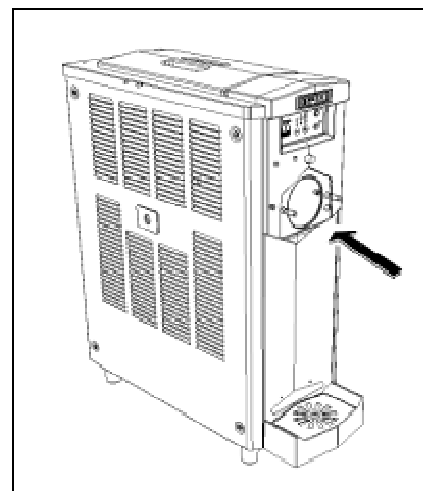

**Fig. 14**

- **R**emove the side drawer as indicated in figure 15 and check for some dripping remembering to reinsert it once checked.

## **!Attention!**

**T**he machine is provided with a left side drawer to collect some dripping from the cylinder backside; it is suggested to check the drawer every time the cleaning operations are performed.

**I**n case some drips are found, it is necessary to check the backside gaskets correct assembly and eventually replace them with new ones.

- **R**epeat the same operations with a sponge soaked in clean water and dry all surfaces thoroughly with a clean cloth.

**O**nce you have performed all these cleaning and sanitising operations thoroughly, you can reassemble the components.

***T**he correct assembly of the appliance is very important to prevent mix leakage and damage to the appliance.*

***T**o assemble the appliance you must have an approved lubricant (vaseline) available.*

***A**lways make sure that all parts have been properly washed and sanitised and that the person carrying out the reassembly has thoroughly washed and disinfected hands and forearms.*

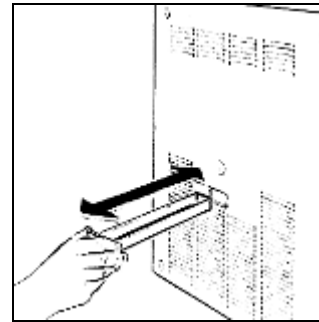

**Fig. 15**

- Once assembled, insert the beater carefully into the cylinder making sure that the rear shank fits perfectly in its seat within the cylinder (fig. 16).

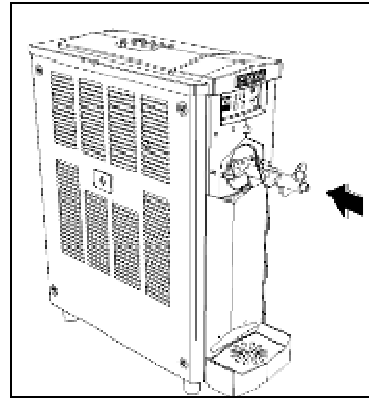

Fig. 16

- After installing the piston seals and lubricating them as necessary (fig. 17), insert the piston into its housing in the flange, mount the dispensing lever together with its spring and connect them with the fixing pin (fig. 17).

### **!ATTENTION!**

An imperfectly fitted tap will compromise its seal.

- Carefully lubricate the sealing gasket of the front flange (fig. 18).

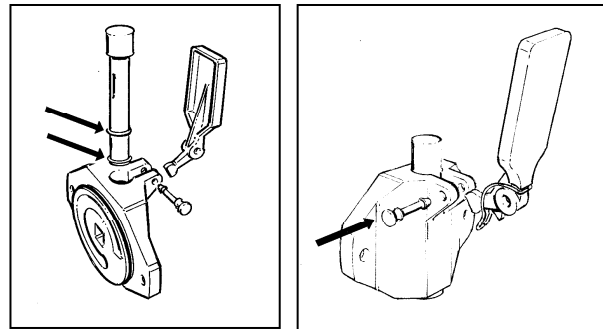

Fig. 17

- Refit the flange so that the locating pin mates with its seat (fig. 19).

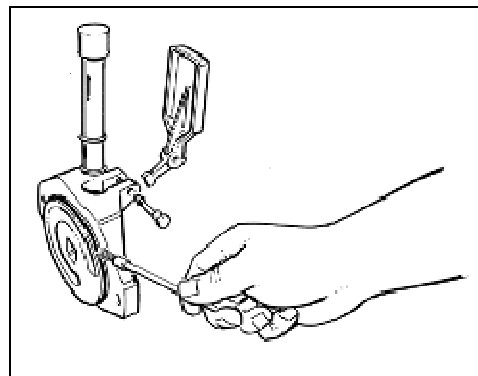

Fig. 18

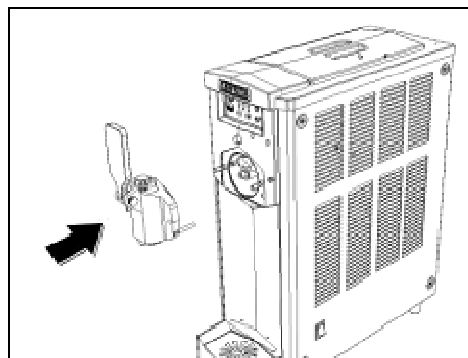

Fig. 19

- **O**nce you have correctly mounted the flange, screw the security knobs right down (fig. 20).
- **O**nce all the components of the freezing cylinder have been refitted, place all components of the top tank in the same position they occupied before the sanitisation (fig. 21).
- **R**eplace the drip tray (fig. 22).
- **O**nce cleaned, before starting up the machine perform the sanitizing procedure as described in the next page.

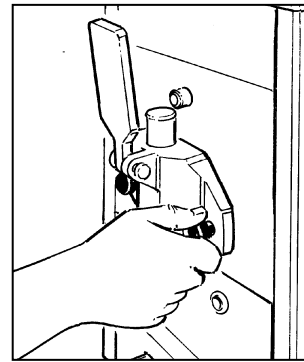

Fig. 20

## Sanitization

If the appliance is not used for some days after being thoroughly cleaned and sanitised as described in Chapter 1, at restart the following sanitising operations should be carried out.

- **T**ake off the lid.
- **F**ill the top tank with water and sanitizer for objects for food use (use **S**odium hypochlorite 2% sanitizer/cleaner), carefully following the doses prescribed by the manufacturer of the same.

- **S**tart the appliance in wash mode and leave for the time specified by the manufacturer.

## IMPORTANT

**Do not leave the sanitizer in the tank for periods in excess of those prescribed by the manufacturer.**

- **E**mpy the tank by opening and closing the tap at least 10 times in order to sanitise the mix flow zone too.
- **R**inse thoroughly by repeating the same steps but using only clean water in place of the sanitizer.
- **A**fter carefully performing these operations the appliance is ready for use.

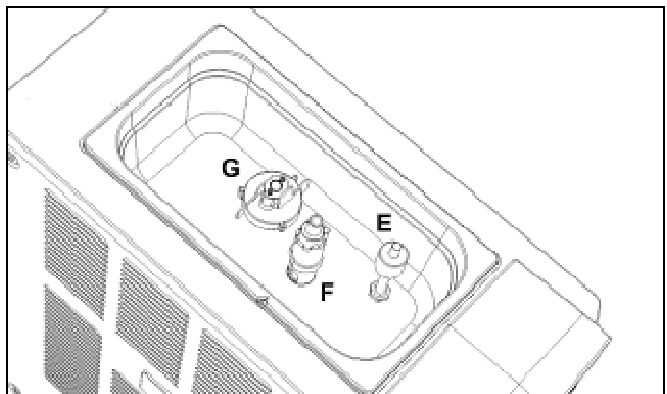

Fig. 21

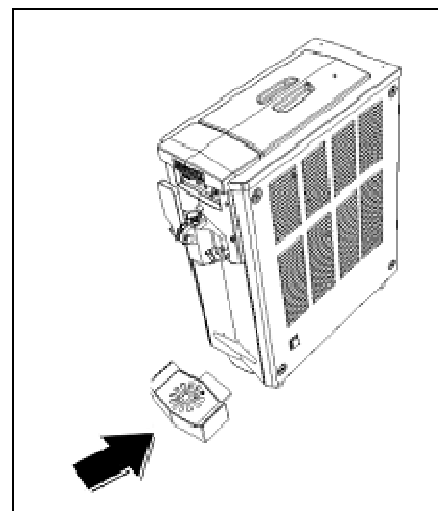

Fig. 22

## 2. SUPPLIED WITH THE APPLIANCE

At the time it is opened, inside the packaging you will find the following items:

- This Operator's manual;
- Declaration of CE Conformity
- 1 tube of lubricant (vaseline);
- 1 drip tray;
- 2 piston o-ring;
- 1 frontal flange gasket;
- 1 cleaning tube brush;
- 1 star shape device.

## 3. ADVICE FOR TRANSPORT

To prevent the oil contained in the hermetic compressor draining into the cooling circuit, the device must be transported, stored and handled in the upright position, following the instructions on the packaging. If the appliance has been accidentally, or intentionally for reasons of transport, held in a non-vertical position it is necessary, before starting up, to keep it for about 3-4 hours in an upright position so that the oil returns to the compressor.

## 4. ADVICE FOR LIFTING

Each appliance is equipped with a special wooden pallet that allows it to be moved using the usual vehicles for handling and lifting.



***Never lift the appliance alone, always seek the help of another operator.***

To avoid damage to the appliance, loading and unloading operations should be carried out with particular care. It is possible to lift the appliance with forklifts, motorised or manual, placing the forks under the appliance.

**The following operations should always be avoided:**

- overturning the appliance
- dragging the appliance with ropes or similar means
- lifting the appliance with slings or ropes
- shaking or jolting the appliance and its packaging

The appliance must be stored in a dry place with temperatures from 0°C to 40°C. In the original packaging up to 2 appliances can be stacked on top of each other, taking care to maintain the vertical position, as shown by the arrows on the packaging.

## 5. TECHNICAL SPECIFICATIONS

### Technical and electrical characteristics of the appliance

All technical and electrical characteristics of the appliance are shown on the data plate inside the appliance and reproduced below.

The plate indicates:

- Model
- Serial number
- Electrical characteristics - volts/Hz
- Max consumption - watts
- Max current - amps
- Weight - kg
- Ambient operating temperature for the appliance is between 24 and 32°C.

The dimensions of the appliance are:

### **K-Soft**

- Height 70 cm
- Width 24 cm
- Depth 57 cm
- Weight 55 kg

### **Karma**

- Height 60 cm
- Width 35.7 cm
- Depth 52.1 cm
- Weight 70 kg

### Noise

A-weighted equivalent continuous sound pressure level is less than 70 dB.

### In case of breakdown:

In most cases, technical problems can be resolved with minor interventions. We therefore recommend you to read this manual carefully before contacting the manufacturer or service centre.

### Disposal

#### **Important**

The packaging must be kept out of the reach of children as it represents a potential safety/health hazard.

#### **Important**

For the sake of the environment, do not dispose of the packaging, but keep it so that you can reuse it if necessary (i.e. winter storage).



The  symbol means that the appliance cannot be disposed of as common waste. It must be handled in compliance with the provisions of European directive 2002/96/EC (Waste Electrical and Electronic Devices - WEEE) and the resulting national legislation, in order to prevent any potential damage to the environment and to avoid health risks. For correct disposal of the appliance, contact the store at which you bought the appliance or our after-sales service.

## 6. POSITIONING

### *FOR MAINTENANCE STAFF ONLY*

**Installation and subsequent maintenance operations must be carried out by staff qualified and trained in the use of the appliance in accordance with the regulations in force.**

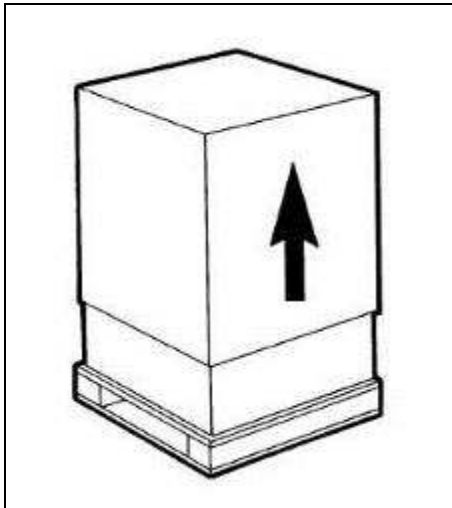

Fig. 23

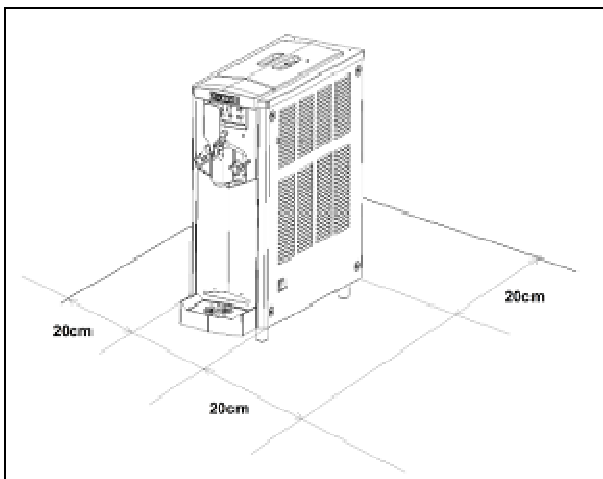

Fig. 24

a) After removing the packaging, **preserve all parts of it for winter storage** and ensure the integrity of the appliance (fig. 24).

### **!IMPORTANT!**

**The packaging must be kept out of the reach of children as it represents a potential safety/health hazard.**

b) Place the appliance on a solid and flat surface leaving 20cm (8 inches) on all the sides so that the body of the appliance is well ventilated. Install the appliance in a dry area and avoid installing it near heat sources.

c) Check that the mains voltage corresponds to that indicated on the data plate and the power available is appropriate for the requirements of the appliance.

Insert the plug into an earthed socket, avoiding multiple sockets.

**FOR FURTHER PRECAUTIONS, READ THE "CONNECTING TO MAINS POWER SUPPLY" SECTION CAREFULLY.**

d) The installation must be performed according to the manufacturer's instructions. Failure to comply with these instructions may impair operation of the appliance.

### **Important**

Earthing is necessary and required by law.

Before carrying out any cleaning or extraordinary maintenance be sure to disconnect the appliance from the mains by removing the power plug.  
In case of breakdown or malfunction switch off the appliance and unplug it.

## 7. CONNECTING TO MAINS POWER SUPPLY

### FOR MAINTENANCE STAFF ONLY

Before inserting the plug into the power socket, as already explained in the previous section, it is necessary that you carefully read the following instructions for your own safety:

- Make sure the connection is made to a system with an effective earth as required by current safety standards (fig. 25). The manufacturer cannot be held responsible for any damage caused by failure to earth the system.

- Always check the electrical specifications on the data plate of each appliance which will always supersede those shown in this manual.

- It is essential, for proper and safe installation, to provide a socket controlled by a circuit breaker with contact opening distance equal to or greater than 3 mm, in accordance with applicable national safety regulations (fig. 25).

- Never use extension cables or multiple sockets.

- Make sure that the power lead is not crushed in any way along its full length.

- To remove the plug, having always first disconnected the main switch, grasp the plug and pull gently.

#### **Important**

IF THE POWER LEAD IS DAMAGED, IT MUST BE REPLACED BY THE MANUFACTURER OR BY ITS SERVICE CENTRE OR BY A SUITABLY-QUALIFIED PERSON IN ORDER TO AVOID HAZARDS.

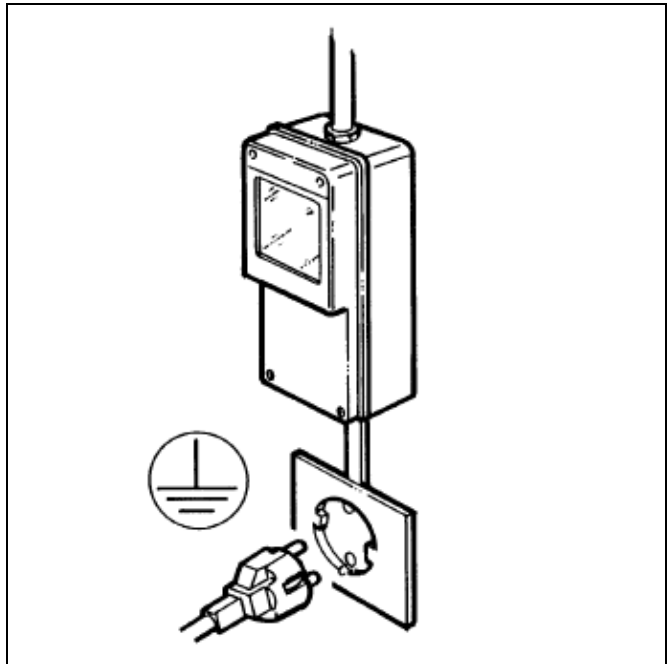

Fig. 25

- If required by local regulations, it is possible to have the appliance permanently connected to electrical power supply, ref. National Electrical Code (NEC) and NFPA 70. If this is the case, it is necessary to remove the right side panel, disconnect the power cable from the machine wiring, remove it from the machine and replace it with the permanent cable by respecting the local codes.



## 8. START-UP PROCEDURES AND METHOD OF USE

***!ATTENTION!  
BEFORE STARTING THE APPLIANCE THE FIRST TIME, CARRY OUT THE CLEANING AND SANITISING PROCEDURES DESCRIBED IN CHAPTER 1.***

- Dilute and mix the preparation in a separate container according to the manufacturer's instructions (fig. 26) without exceeding the following quantities:

KSoft: 1+2 litres  
Karma: 2+4 litres

**NOTE: The blending of water or milk with the preparation is called the mix and makes soft serve ice cream and similar products.**

### ***!ATTENTION!***

Never use the appliance with unsuitable products different from the specific soft ice cream ones. Failure to observe this instruction may cause irreparable damage to components of the appliance.

When you produce a new flavour of ice cream and you start up the appliance for this purpose, we recommend starting by introducing only 0,9 litres of mix needed to fill the freezing cylinder and introduce the remaining product into the top tank only after placing the compression pipe as a junction between the freezing cylinder and the pump.

- Remove the top tank lid (fig. 27).

- Pour the mix into the top tank (fig. 28) and wait for it to flow into the freezing cylinder.

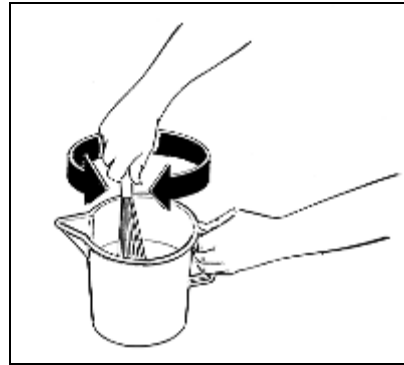

Fig. 26

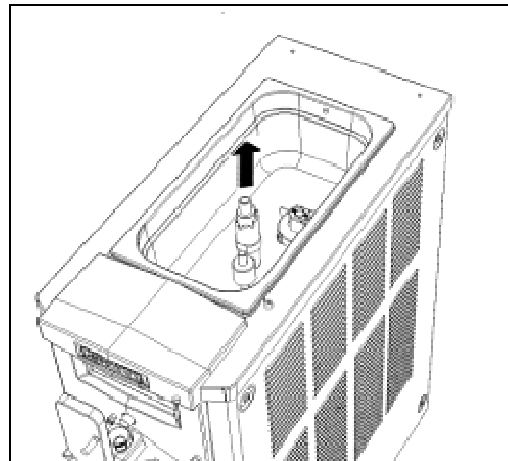

Fig. 27

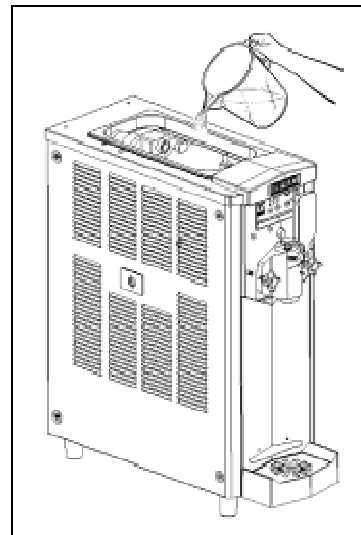

Fig. 28

- Position the air regulation pipe and adjust it, lifting and rotating the upper movable part in a clockwise direction, to the closed position on the lower notch indicated by the arrow (fig. 29).

- Pour the remaining product into the upper tank.

- Replace the cover on the tank, insert the plug and turn on the main switch (fig. 30).

- Select the desired mode of operation from the control panel (fig. 31)

- To activate the cooling system in cooling mode push the power button B on the control panel (fig. 31).

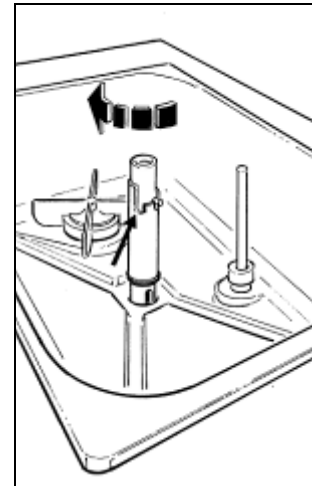

**Fig. 29**

**!ATTENTION!**  
 On pushing the power button the cooling system comes into operation. To prevent the appliance being damaged, always make sure you have already introduced the mix into the tank before activating the cooling system. Never activate it with the tank empty.

- To change the consistency of the mix, press the + and – keys of the control panel (fig. 31). Pressing + will cause the number of LEDs lit to rise and consequently the consistency setting increases. Pressing – instead will decrease the number of LEDs lit and reduce the mix consistency (fig. 31).

- If the – key is pushed until all three consistency LEDs go out, the appliance will go into defrost mode. This mode will be indicated by the fact that only the LED of the power button B is lit.

- To activate wash mode, push the button WASH button (button C in fig. 31) after switching off the cooling system by pressing the power button B and making sure that its LED is off.

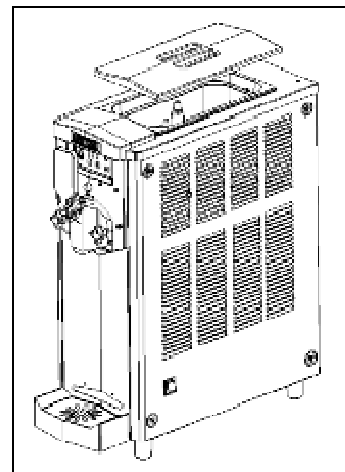

**Fig. 30**

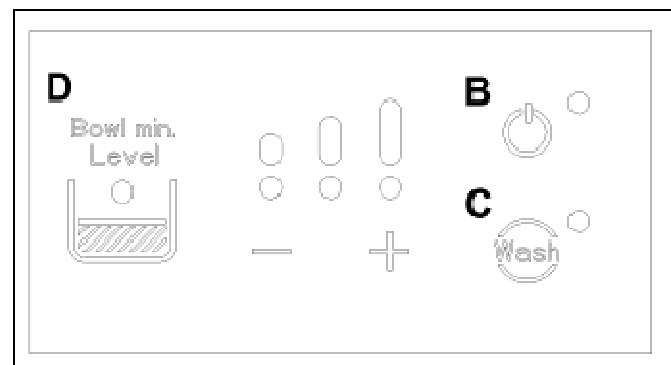

**Fig. 31**

**!Important!**

Defrost or wash modes are not to be used in lieu of proper cleaning or sanitization procedures at the frequency of federal, state or local regulatory agencies.

NOTE: when the consistency LEDs flash, it means that the cooling system is operating as the consistency setting has not yet been reached.

**- Once the product has reached the desired consistency the LEDs will stop flashing and the rotation of the beater will stop.**

- In the first production phase, at this point it is necessary to open the air regulation pipe and adjusting it to the desired level.

- Lifting and turning the upper part of the tube counter clockwise (fig. 32), and positioning the pin on the notches which become gradually higher, increases the amount of mix that can flow into the freezing chamber so changing the consistency and the bulk of the same.

- To dispense, place a glass under the tap and pull the lever as shown in fig. 33. The beater will begin to rotate again, starting the dispensing phase.

**!ATTENTION!**

In order to avoid any damaging on the machine due to the lack of product, when the level is low in the upper tank the machine is blocked until that level has been restored. That block is underlined by an alarm.

**- When the product level LED D and the power LED B (fig. 34) are lit with a buzzer sound activated, it means that the product level in the top tank is low and should be refilled; in these conditions the appliance is blocked and only the dispensing system will be activated if necessary until the product level has been restored.**

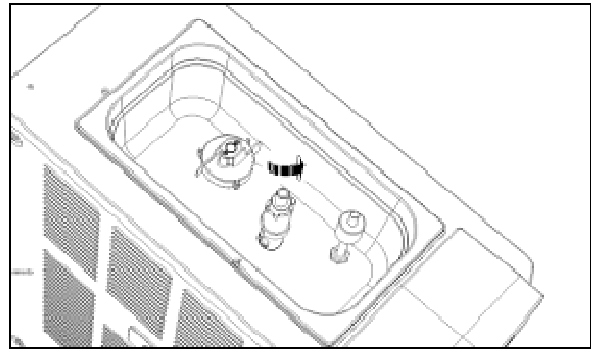

Fig. 32

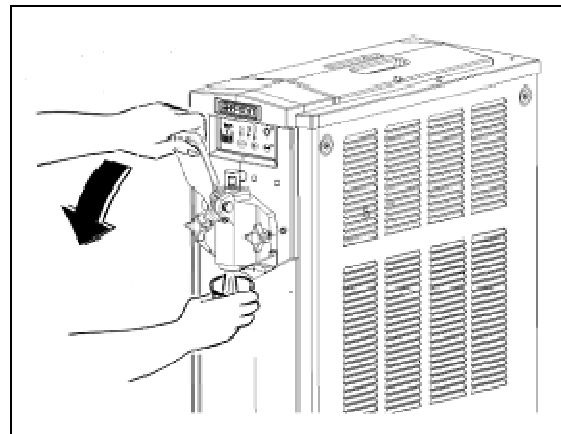

Fig. 33

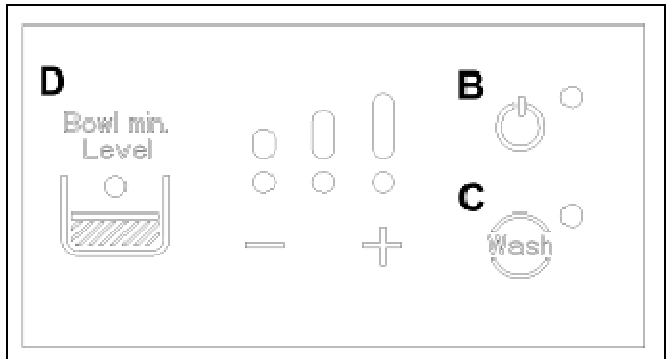

Fig. 34

## 9. EXTRAORDINARY MAINTENANCE



**Before carrying out any maintenance, you must switch off the appliance and unplug the power lead from the socket.**

### ***Cleaning the condenser filter (only for KSoft)***

In order to ensure good performance of the cooling system, it is essential to clean the condenser filter at least **once a month, or whenever the level of clogging necessitates it.**

To do that:

- Switch off the power to the appliance by turning off the main switch and disconnect the power lead.
- Remove the filter from its seat under the machine (fig.35) and clean it by washing it with water.

### **IMPORTANT**

**Never use a screwdriver or any other sharp object to remove dirt accumulated between the fins of the condenser.**

- Dry the filter and store it back in place before starting the machine again.

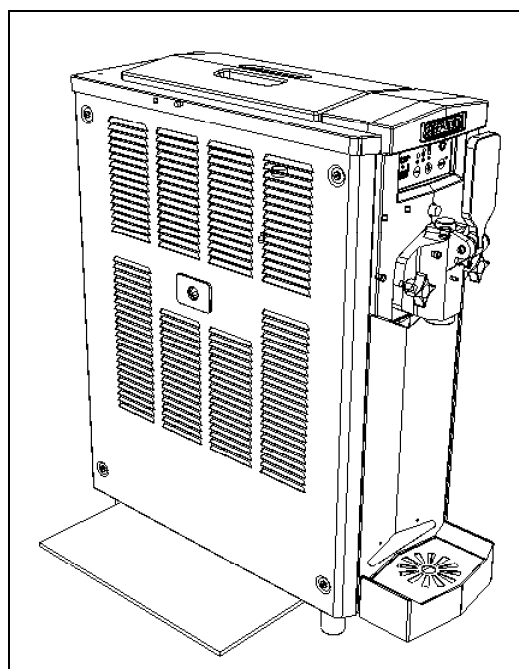

**Fig. 35**

## ***Checking and replacing the seals***

### **BEATER AND FLANGE SEAL**

The front side flange seal should be replaced every 6 months depending on the state of wear and the level of maintenance and lubrication.

### **TAP (O-RING) SEALS**

The o-ring seals of the dispensing tap should be replaced whenever they appear worn. These seals should be lubricated each time the appliance is reassembled after cleaning and checked carefully in order to avoid unwanted leaks.

### **SHAFT BACKSIDE SEALS**

The auger backside seal has to be replaced every time some dripping into the drawer is evident.

## ***Winter storage***

To protect the appliance during periods of inactivity such as winter, it is important to store it properly as described below:

- Disconnect the appliance from the power source.
- Dismantle, wash and sanitise all parts in contact with the mix as described in Chapter 9.
- Also clean the exterior panels.
- Reassemble all components carefully.
- Cover the completely-reassembled appliance with the original packaging so that it is protected from dust and other contaminants.
- Position the appliance in a dry place.

## ***Product storage***

Since the conservation of the product used depends on the temperature and duration of storage, it is absolutely necessary to refer to the instructions and specifications of the manufacturer in order to avoid health risks due to deterioration of the product under incorrect conservation conditions.

## 10. USEFUL INFORMATION ON ICE CREAM MIXES

### VOLUME INCREASE

During the transition from the initial liquid state to the thick and creamy final state, the mix considerably increases its volume. The ability to quantify the extent of this increase can be very useful in order to avoid the tank overflowing due to an excessive amount of product.

By following these simple steps you will be able to calculate the extent of this increase.

- Place an empty container on some scales and calibrate the zero setting
- Remove the container, fill it completely with liquid product, weigh it and record this value
- Repeat the same steps, completely filling the container with mix having the desired density, weigh it and note the value obtained
- Apply the following formula to calculate the percentage of increase in the volume:

*"Weight of the liquid mix less the weight of the denser creamy mix, divided by the weight of the creamy mix and then multiplied by 100"*

Example:

Weight of half a litre of mix: 530g

Weight of half a litre of creamy mix: 380g

Difference: 150g

$150/380 = 0.4$

$0.4 \times 100 = 40\%$  increase in volume

## 11. DISCLAIMER

The manufacturer declines any liability for damage that may occur directly or indirectly to persons, property and animals as a result of failure to observe all the instructions given in this manual and especially the warnings concerning installation, use and maintenance of the appliance.

The manufacturer is not liable for any inaccuracies due to printing, transcription or translation errors contained in this manual. The right is reserved to make any necessary or useful changes, also those in the interest of the user, without compromising the essential functional and safety features.

## 12. TROUBLESHOOTING GUIDE

**NOTE: The following procedures must be performed by qualified technical staff**

<b>Problem</b>	<b>Possible cause</b>	<b>Solution</b>
The appliance does not cool, or cools only partially, and the compressor is running	<ul style="list-style-type: none"> <li>The space around the appliance is inadequate for ventilation</li> <li>The appliance is operating in wash mode</li> <li>The fan is not functioning</li> <li>There is a loss of coolant</li> </ul>	<ul style="list-style-type: none"> <li>Allow at least 20 cm of free space around the appliance and place it away from other heat sources</li> <li>Turn on the cooling system by turning off wash mode and activating cooling mode</li> <li>Check the electrical connections, if necessary replace the fan</li> <li>Find the leak, eliminate it and recharge the system</li> </ul>
The appliance does not cool, or cools only partially, and the compressor is not running	<ul style="list-style-type: none"> <li>Electrical components of the compressor are not functioning</li> <li>Some electrical connections are disconnected</li> <li>Defective compressor</li> </ul>	<ul style="list-style-type: none"> <li>Replace non-functioning components</li> <li>Check electrical connections</li> <li>Replace the compressor</li> </ul>
The appliance is noisy	<ul style="list-style-type: none"> <li>The beater and its components have not been installed correctly</li> <li>The freezing cylinder is empty</li> <li>The fan blades are impacting internal components</li> </ul>	<ul style="list-style-type: none"> <li>Dismantle the beater and reassemble the parts correctly</li> <li>Find the root cause and solve it in order to have it running with product</li> <li>Check and adjust</li> </ul>
The main switch is in the ON position but the appliance does not run	<ul style="list-style-type: none"> <li>The front flange has not been positioned correctly</li> <li>Some electrical connections are disconnected</li> <li>The switch is broken</li> <li>The electronic panel is defective</li> <li>The agitator motor is defective</li> </ul>	<ul style="list-style-type: none"> <li>Correctly position the front flange</li> <li>Check electrical connections</li> <li>Replace the switch</li> <li>Replace the electronic panel</li> <li>Replace the agitator motor</li> </ul>
The appliance leaks from the side drawer	<ul style="list-style-type: none"> <li>The seal contact surface is dirty or damaged</li> </ul>	<ul style="list-style-type: none"> <li>Check and clean or replace the seal</li> </ul>
The appliance is running and the top tank is filled with liquid product but nothing comes out of the tap	<ul style="list-style-type: none"> <li>The pump is not working</li> <li>The mix in the cylinder is too dense</li> </ul>	<ul style="list-style-type: none"> <li>Check and solve</li> <li>Establish why the mixture thickens excessively, resolve the problem and restart the appliance replacing the mix</li> </ul>
The tap is leaking	<ul style="list-style-type: none"> <li>The tap has not been reassembled correctly</li> <li>The movement of the tap is impeded</li> <li>The o-ring seals are damaged or worn</li> </ul>	<ul style="list-style-type: none"> <li>Dismantle and reassemble the tap correctly</li> <li>Clean the tap and its housing and lubricate with the vaseline supplied</li> <li>Replace the o-rings</li> </ul>
The beater does not turn	<ul style="list-style-type: none"> <li>The front flange is not mounted correctly</li> <li>Some electrical connections are disconnected</li> <li>The electronic panel is defective</li> <li>The agitator motor is defective</li> </ul>	<ul style="list-style-type: none"> <li>Mount the front flange correctly</li> <li>Check electrical connections</li> <li>Replace the electronic panel</li> <li>Replace the agitator motor</li> </ul>
The beater is noisy during rotation	<ul style="list-style-type: none"> <li>The cylinder is empty</li> </ul>	<ul style="list-style-type: none"> <li>Check the root cause and solve</li> </ul>
Buttons do not respond to being pressed	<ul style="list-style-type: none"> <li>The keypad is defective</li> <li>The electronic panel is blocked or defective</li> </ul>	<ul style="list-style-type: none"> <li>Replace the keypad</li> <li>Turn the appliance off and on and if the problem persists, replace the panel</li> </ul>

<b>Problem</b>	<b>Possible cause</b>	<b>Solution</b>
The LED for the ON button and the one for the level are ON and the buzzer alarm is playing	<ul style="list-style-type: none"> <li>• Product level low in the upper tank</li> </ul>	<ul style="list-style-type: none"> <li>• Refill product in the upper tank</li> </ul>
The LED for the ON button is blinking and the buzzer alarm is playing	<ul style="list-style-type: none"> <li>• Tank probe detached</li> <li>• Temperature inside the tank is too high</li> </ul>	<ul style="list-style-type: none"> <li>• Reconnect probe</li> <li>• Turn off the appliance and wait a few minutes for the temperature of the system, which has been raised by washing with hot water, to decrease</li> </ul>
The LED for the ON button and the one for the level are blinking and the buzzer alarm is playing	<ul style="list-style-type: none"> <li>• Product temperature too low</li> <li>• Temperature probe short circuit</li> </ul>	<ul style="list-style-type: none"> <li>• The amount of mix in the freezing cylinder is too small, top up the top tank or open mix flow tube</li> <li>• Replace probe</li> </ul>



### 13.WIRING DIAGRAM

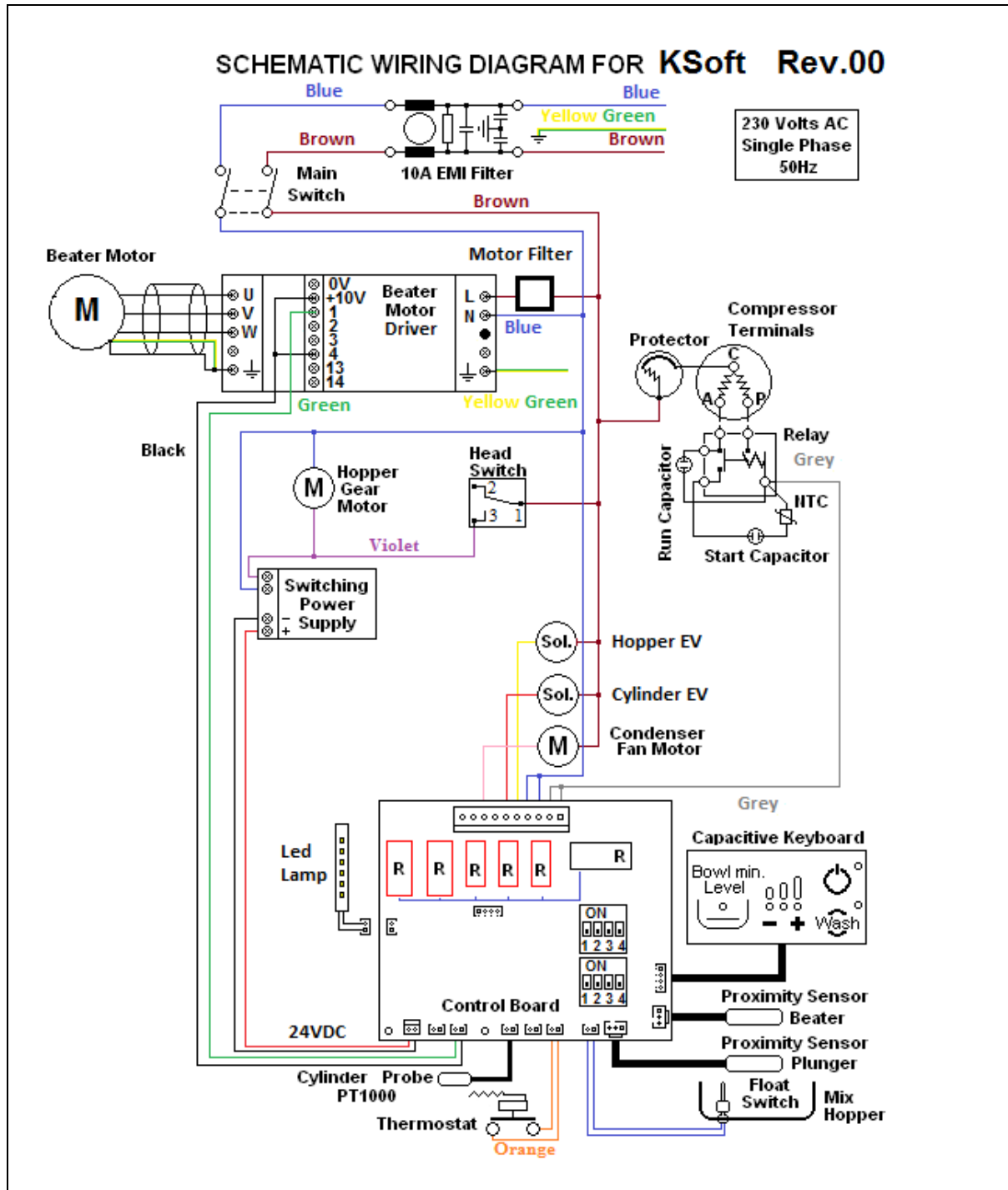







Electrolux Professional SPA  
Viale Treviso 15  
33170 Pordenone  
[www.electrolux.com/professional](http://www.electrolux.com/professional)