

INSTRUCTION REF: IN101
ISSUE NO. 4
DATE - 21.03.16
Page 1 of 18

INSTRUCTIONS

MODEL: AG2H, AG4H and AG6H

SAFETY INSTRUCTIONS

INSTALLATION INSTRUCTIONS

OPERATION INSTRUCTIONS

MAINTENANCE INSTRUCTIONS

CONVERSION INSTRUCTIONS

TECHNICAL DATA

PARTS LIST

SPARES LIST

WARRANTY INFORMATION

Customer Information

MODEL NUMBER: _____
SERIAL NUMBER: _____
PURCHASE DATE: _____
DISTRIBUTOR: _____

INSTRUCTION REF: IN101
ISSUE NO. 4
DATE - 21.03.16
Page 2 of 18

SAFETY INSTRUCTIONS

IMPORTANT, PLEASE READ INSTRUCTIONS FULLY BEFORE USE

THIS APPLIANCE IS ONLY FOR PROFESSIONAL USE AND MUST ONLY BE USED BY QUALIFIED PEOPLE.

Attention should be drawn to the fact that parts of this unit by necessity, will get VERY HOT, and will cause burns if touched accidentally. Therefore it is the responsibility of the supervisor or equivalent to provide SUITABLE PROTECTIVE CLOTHING for the user.

THIS APPLIANCE MUST BE FITTED AND TESTED BY A REGISTERED FITTER BEFORE USE.

The unit should be installed in compliance with the INSTALLATION INSTRUCTIONS and the NATIONAL REGULATIONS in force at the time. Particular attention should be paid to the Gas Safety (Installation and Use) Regulations and the Health and Safety at Work Act.

Each appliance requires a flow of fresh air for combustion. Under no circumstances should air vents on the appliances, or air vents installed by the fitter in the room of the appliance to supply combustion air, be altered or omitted in any way.

To prevent shocks, all appliances whether gas or electric, must be earthed.

ANY GAS CONVERSIONS NEEDED TO BE MADE TO THE PRODUCT MUST BE CARRIED OUT BY A GAS SAFE REGISTERED ENGINEER

To avoid scratching the highly polished exterior surface of this equipment whilst in transit, the protective film on the exterior surfaces has NOT been removed.

It is IMPORTANT that this protective film is peeled off before the equipment is used.

INSTRUCTION REF: IN101

ISSUE NO. 4

DATE - 21.03.16

Page 3 of 18

MODEL AG2H, AG4H and AG6H

The products stated above are designed and built to comply with the following standards:

BS EN 203-1

BS EN 203-2-1

The products have been CE-marked in compliance with the **European Gas Directive (90/396/EEC)**

INSTALLATION INSTRUCTIONS

ALL APPLIANCES MUST BE FITTED AND OR CONVERTED BY A REGISTERED INSTALLER, IN ACCORDANCE WITH CURRENT REGULATIONS.

INSTALLATION

Before installation check data plate on rear of unit to ensure appliance is suitable for gas supply available.

During installation provision must be provided for combustion air to the appliance through base and rear of appliance. This should not be blocked at any time. This appliance should be installed with sufficient ventilation to prevent the occurrence of unacceptable concentrations of substances harmful to health in the room in which it is installed.

POSITIONING

The appliance must not be installed on or against combustible surfaces – minimum clearances must be :

Rear 150mm (6")

Sides 150mm (6")

Hotplate to combustible material 1525mm (60")

All local fire regulations should be observed.

It is recommended that the appliance be sited below a ventilating hood preferably of the extractor type incorporating a grease filter.

INSTRUCTION REF: IN101
ISSUE NO. 4
DATE - 21.03.16
Page 4 of 18

GAS CONNECTION

The size of the supply pipe should be no less than 3/4" B.S.P. and an easily accessible isolation tap fitted close to the appliance in the gas line. Although a rigid connection is recommended. An approved armoured flexible pipe may be used in conjunction with a straining cable.

Before the appliance is commissioned the gas safety regulations require that all connections on the gas line are tested for gas soundness between the gas meter and the appliance.

All packing and protective film must be removed from panels etc. prior to commissioning the appliance.

All gas appliances must be fitted by a competent person to gas safety regulations in force.

INSTRUCTION REF: IN101
ISSUE NO. 4
DATE - 21.03.16
Page 5 of 18

OPERATING INSTRUCTIONS

FOR FITTING INSTRUCTIONS SEE INSTALLATION SECTION.

All burners are fitted with flame failure devices.

- (a) To light hob unit turn knob to 
- (b) Press in and ignite gas with a match, keep knob held in for 15-20 seconds.
- (c) Release knob, gas should stay lit, if gas goes out repeat (b)
- (d) The burner is now on full gas, to turn gas down turn knob anti-clockwise, this is the lowest setting which is factory set.
- (e) To turn burners off, turn knob clockwise all the way round.

Parry recommends that the hob is used only with pans that have a minimum diameter of 120mm, and up to a maximum of 295mm diameter. This ensures that there is satisfactory combustion, and the pan is stable as it sits on the finger of the pan support.

We advise these appliances should not be left unattended while switched on.

These appliances are for professional use by qualified people only.

There are no user serviceable parts.

It is recommended that the sealed top plate is cleaned regularly to prevent build up of fat and grease.

INSTRUCTION REF: IN101
ISSUE NO. 4
DATE - 21.03.16
Page 6 of 18

MAINTENANCE INSTRUCTIONS

MAINTENANCE AND SERVICE MUST ONLY BE UNDERTAKEN BY REGISTERED FITTERS.

PLEASE NOTE THE LOW RATE ADJUSTER ON THE UNIT HAS BEEN FACTORY SET AND SHOULD NOT BE ADJUSTED UNLESS BY A QUALIFIED ENGINEER IN WHICH CASE THE LOW RATE ADJUSTER SHOULD BE RE-SEALED.

Parry recommends that this unit is serviced at least every 12 months

As part of a full service we recommend the following checks are carried out.

- Before any maintenance isolate the appliance from the gas supply
- Examine and clean all burner and flame retention ports.
- Using a combination of brushes, remove dust and lint from within the primary air ports venture and burners. Check the burner aeration to ensure it is clear of debris.
- Clean burner injectors ensuring orifices are not enlarged or damaged.
- Stiff gas controls can in some instances be greased. Please ensure the correct type or grease is used.
- Reconnect gas supply and test all disturbed gas connections for gas tightness using a non corrosive leak detection fluid.
- Check the appliance burner operating pressure, heat input rating or where necessary both.

GENERAL CLEANING

It will be found that it takes less time and effort to clean the hob every time it has been used, particularly whilst still warm before grease and spillages are burnt on. Proprietary cleaners must be used with care – they are highly corrosive and may cause damage to surfaces and components. The stainless outer panels require a wipe down with warm soapy water.
DO NOT USE SCOURING PADS.

INSTRUCTION REF: IN101
ISSUE NO. 4
DATE - 21.03.16
Page 7 of 18

FAULT FINDING

Fault	Possible Cause	Remedy
Incorrect flame picture, flame lift or noisy burner	Incorrect burner pressure, Blocked or partially blocked injector. Inadequate ventilation. Burner faulty/corroded/blocked	Check/adjust burner pressure Check /clean injector, Check ventilation. Check / clean burner and replace as necessary.
Burners will not stay alight	Faulty connection at thermocouple-valve, incorrectly located	Remake connection, reposition thermocouple
Burner goes out when turned to "low"	Blockage in tap	Clean and re-grease
Irregular flame	Burner ring/cap not correctly located, or low pressure	Relocate and check pressure at test point.

REPLACING FAULTY COMPONENTS

For Gas Safe Engineers only

HOB TAP- Remove pan supports, pull off control knobs and unclip fascia panel. Disconnect burner supply tube and thermocouple. Undo the 2 screws securing the tap to the rail. Check sealing washer and replace if necessary. Assemble in reverse order.

HOB BURNER/THERMOCOUPLE – Remove Pan Supports and Burner caps. Remove the solid top tray. Disconnect thermocouple from rear of tap. Undo locknut on burner mounting channel. Assemble in reverse order.

INSTRUCTION REF: IN101
 ISSUE NO. 4
 DATE - 21.03.16
 Page 8 of 18

LPG - Conversion Instructions

<u>Product</u>	Alpha Gas Hobs
-----------------------	----------------

For use with models with the following serial numbers

<u>Model</u>	<u>From</u>	<u>To</u>
AG2H-4		
AG4H-4		
AG6H-4		

These instructions can be used for converting from Natural Gas to LPG

LPG units are designed and tested in accordance with all current regulations enforced to run on the following gases only

Propane G31 @ 37mbar 14.8" W.G.

PLEASE NOTE

This conversion must be carried out by a Gas Safe Registered Engineer.

This conversion kit includes

	Description	Product Code	Quantity	Quantity	Quantity
			AG2H	AG4H	AG6H
Hob valve bypass screw	LPG hob valve bypass screw stamped 50	COPBPS-50	2	4	6
Hob burner injector	LPG hob burner injector stamped 105	HOBINJECT105	2	4	6
Labels		G31 ONLY,	1	1	1
Instructions			CONVIN20-4	CONVIN22-4	CONVIN24-4

INSTRUCTION REF: IN101
ISSUE NO. 4
DATE - 21.03.16
Page 9 of 18

NAT GAS - Conversion Instructions

<u>Product</u>	<u>Alpha Gas Hobs LPG</u>
-----------------------	----------------------------------

For use with models with the following serial numbers

<u>Model</u>	<u>From</u>	<u>To</u>
AG2HP-4		
AG4HP-4		
AG6HP-4		

These instructions can be used for converting from LPG to Natural Gas

LPG units are designed and tested in accordance with all current regulations enforced to run on the following gases only

Nat Gas G20 @ 20mbar 8" W.G.

Nat Gas G25 @ 25mbar 10" W.G. (Must be converted by manufacturers only)

PLEASE NOTE

This conversion must be carried out by a Gas Safe Registered Engineer.

This conversion kit includes

	Description	Product Code	Quantity AG2HP	Quantity AG4HP	Quantity AG6HP
Hob valve bypass screw	NAT GAS Hob valve bypass screw stamped with 85	COPBPS - 85	2	4	6
Hob burner injector	NAT GAS Hob Burner Injector stamped with 185	HOBINJECT185	2	4	6
Labels		NAT. GAS ONLY + G20	1	1	1
Instructions			CONVIN21 -4	CONVIN23 -4	CONVIN25 -4

INSTRUCTION REF: IN101
ISSUE NO. 4
DATE - 21.03.16
Page 10 of 18

Conversion Procedure for Hob Burners

Warning

Ensure the appliance is isolated from the gas supply before commencing conversion

Remove pan support and burner caps.



Lift off aluminium burner plates.







Remove the solid top plate.



Using a 10mm spanner remove burner injector. Replace with injector from conversion kit. Replace solid top plate, aluminium burner plates and burner caps.

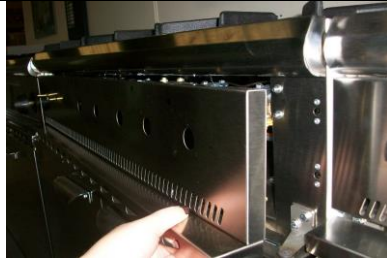

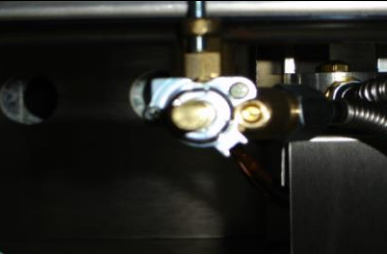
INSTRUCTION REF: IN101
ISSUE NO. 4
DATE - 21.03.16
Page 11 of 18

<p>Remove the tap knobs to allow the fascia to unclip.</p>		
<p>Remove low rate screws in tap body and replace with low rate screw from the conversion kit.</p>		
<p>Connect the unit back to the gas supply Test for gas soundness Replace the fascia and knobs accordingly</p>		
<p>When conversion is complete affix new data label and gas type label supplied with the conversion kit, detailing type of gas and pressure.</p>		

INSTRUCTION REF: IN101
 ISSUE NO. 4
 DATE - 21.03.16
 Page 12 of 18

TECHNICAL DETAILS : MODEL AG2H

Per Burner

GAS	OPERATING PRESSURE	TOTAL HEAT INPUT
NATURAL G20	20mb / 8" W.G.	5.557 KW = 18959 Btu/h
PROPANE G31	37mb / 14.8" W.G.	4.351 KW = 14846 Btu/h
G25	25mb / 10" W.G.	4.973 KW = 16966 Btu/h

GAS RATE	M³/HR	FT³/HR	LB/HR	KG/HR
NATURAL G20	0.588 M ³ /HR	20.765 FT ³ /HR		
PROPANE G31	0.178 M ³ /HR	6.286 FT ³ /HR	0.691 LB/HR	0.313 KG/HR
G25 @ 25mb	0.612 M ³ /HR	21.613 FT ³ /HR		
AIR FLOW RATE FOR COMBUSTION 20m³/HR		FT ³ /HR		

BURNER LOW RATE	M³/HR
NATURAL G20	0.125 M ³ /HR
PROPANE G31	0.041 M ³ /HR
G25	0.125 M ³ /HR

Total Unit

GAS	OPERATING PRESSURE	TOTAL HEAT INPUT
NATURAL G20	20mb / 8" W.G.	11.113 KW = 37918 Btu/h
PROPANE G31	37mb / 14.8" W.G.	8.702 KW = 29692 Btu/h
G25	25mb / 10" W.G.	9.945 KW = 33932 Btu/h

GAS RATE	M³/HR	FT³/HR	LB/HR	KG/HR
NATURAL G20	1.176 M ³ /HR	41.530 FT ³ /HR		
PROPANE G31	0.356 M ³ /HR	12.572 FT ³ /HR	1.382 LB/HR	0.627 KG/HR
G25 @ 25mb	1.224M ³ /HR	43.225 FT ³ /HR		
AIR FLOW RATE FOR COMBUSTION 20m³/HR		12.24FT ³ /HR		

INJECTORS

Natural G20 = INJECT185
 Propane G31 = LPGINJECT1.05
 G25 @ 25mb = INJECT185

INSTRUCTION REF: IN101
 ISSUE NO. 4
 DATE - 21.03.16
 Page 13 of 18

TECHNICAL DETAILS : MODEL AG4H

Per Burner

GAS	OPERATING PRESSURE	TOTAL HEAT INPUT
NATURAL G20	20mb / 8" W.G.	5.557 KW = 18959 Btu/h
PROPANE G31	37mb / 14.8" W.G.	4.351 KW = 14846 Btu/h
G25	25mb / 10" W.G.	4.973 KW = 16966 Btu/h

GAS RATE	M ³ /HR	FT ³ /HR	LB/HR	KG/HR
NATURAL G20	0.588 M ³ /HR	20.765 FT ³ /HR		
PROPANE G31	0.178 M ³ /HR	6.286 FT ³ /HR	0.691 LB/HR	0.313 KG/HR
G25 @ 25mb	0.612 M ³ /HR	21.613 FT ³ /HR		
AIR FLOW RATE FOR COMBUSTION 20m ³ /HR		6.12 FT ³ /HR		

BURNER LOW RATE	M ³ /HR
NATURAL G20	0.125 M ³ /HR
PROPANE G31	0.041 M ³ /HR
G25	0.125 M ³ /HR

Total Unit

GAS	OPERATING PRESSURE	TOTAL HEAT INPUT
NATURAL G20	20mb / 8" W.G.	22.226 KW = 75836Btu/h
PROPANE G31	37mb / 14.8" W.G.	17.404 KW = 59384 Btu/h
G25	25mb / 10" W.G.	19.890 KW = 67865 Btu/h

GAS RATE	M ³ /HR	FT ³ /HR	LB/HR	KG/HR
NATURAL G20	2.352 M ³ /HR	83.060 FT ³ /HR		
PROPANE G31	0.712 M ³ /HR	25.144 FT ³ /HR	2.763 LB/HR	1.253 KG/HR
G25 @ 25mb	2.448 M ³ /HR	86.450 FT ³ /HR		
AIR FLOW RATE FOR COMBUSTION 20m ³ /HR		24.48FT ³ /HR		

INJECTORS

Natural G20 = INJECT185
 Propane G31 = LPGINJECT1.05
 G25 @ 25mb = INJECT185

INSTRUCTION REF: IN101
 ISSUE NO. 4
 DATE - 21.03.16
 Page 14 of 18

TECHNICAL DETAILS : MODEL AG6H

Per Burner

GAS	OPERATING PRESSURE	TOTAL HEAT INPUT
NATURAL G20	20mb / 8" W.G.	5.557 KW = 18959 Btu/h
PROPANE G31	37mb / 14.8" W.G.	4.351 KW = 14846 Btu/h
G25	25mb / 10" W.G.	4.973 KW = 16966 Btu/h

GAS RATE	M³/HR	FT³/HR	LB/HR	KG/HR
NATURAL G20	0.588 M ³ /HR	20.765 FT ³ /HR		
PROPANE G31	0.178 M ³ /HR	6.286 FT ³ /HR	0.691 LB/HR	0.313 KG/HR
G25 @ 25mb	0.612 M ³ /HR	21.613 FT ³ /HR		
AIR FLOW RATE FOR COMBUSTION 20m³/HR		6.12 FT ³ /HR		

BURNER LOW RATE	M³/HR
NATURAL G20	0.125 M ³ /HR
PROPANE G31	0.041 M ³ /HR
G25	0.125 M ³ /HR

Total Unit

GAS	OPERATING PRESSURE	TOTAL HEAT INPUT
NATURAL G20	20mb / 8" W.G.	33.340 KW = 113755 Btu/h
PROPANE G31	37mb / 14.8" W.G.	26.107 KW = 89076 Btu/h
G25	25mb / 10" W.G.	29.835 KW = 101797 Btu/h

GAS RATE	M³/HR	FT³/HR	LB/HR	KG/HR
NATURAL G20	3.528 M ³ /HR	124.590 FT ³ /HR		
PROPANE G31	1.068 M ³ /HR	37.716 FT ³ /HR	4.145 LB/HR	1.880 KG/HR
G25 @ 25mb	3.672 M ³ /HR	129.675 FT ³ /HR		
AIR FLOW RATE FOR COMBUSTION 20m³/HR		36.72 FT ³ /HR		

INJECTORS

Natural G20 = INJECT185
 Propane G31 = LPGINJECT1.05
 G25 @ 25mb = INJECT185

INSTRUCTION REF: IN101
ISSUE NO. 4
DATE - 21.03.16
Page 15 of 18

PARTS LIST

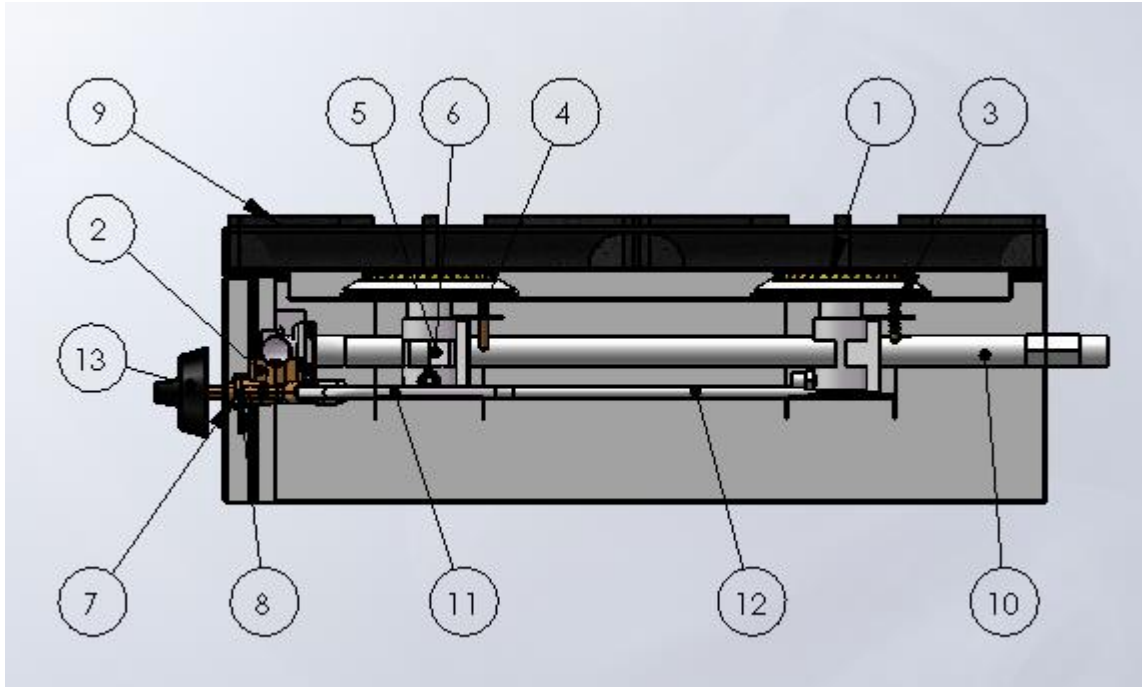

Item Number	Parts	AG2H	AG4H	AG6H
1	BURNRHOB	x2	x4	x6
2	GASTAPHOB	x2	x4	x6
3	THCP600ISP	x1	x2	x3
4	THCP320ISP	x1	x2	x3
5	HOBINJECT185	x2	x4	x6
6	HOBINJECT105	x2	x4	x6
7	COPBPS-85NAT	x2	x4	x6
8	COPBPS-50LPG	x2	x4	x6
9	CASTP6BO	x1	x2	x3
10	PG2H22RAIL	x1		
10	PG4H22RAIL		x1	
10	PG6H22RAIL			x1
11	FLEXT250X8	x1	x2	x3
12	FLEXT500X8	x1	x2	x3
13	ULTKNOB2	x2	x4	x6

INSTRUCTION REF: IN101
ISSUE NO. 4
DATE - 21.03.16
Page 16 of 18

WARRANTY INFORMATION

WARRANTY POLICY

- The manufacturers warranty is only valid in the UK mainland & Northern Ireland, Western Isles, Inner Hebrides and Islands are parts only warranty.
- All service calls will be carried out between the hours of 8.00am – 5.00pm Monday to Friday only.
- We accept no responsibility for delays in replacing or repairing the equipment due to circumstances beyond our control.
- Your warranty can be immediately invalid if the installation of the equipment has not been installed in accordance with the manufactures instruction. (See installation details). Also the miss-use, alteration or unauthorised repairs of the equipment will invalidate the warranty.
- During the warranty period it is at Parrys discretion to repair or replace the equipment.
- Warranty only applies if the equipment has been used in a professional manor following the manufactures instructions and maintenance guide lines.
- The warranty covers defects in the material and components failure only we are not liable for trading loss, loss of perishable items, water damage, loss due to injury or fire damage.

INSTRUCTION REF: IN101
ISSUE NO. 4
DATE - 21.03.16
Page 17 of 18

WARRANTY REQUEST

- Please ensure you have referred to the manufacturers' instruction before placing a warranty call. Or contact our warranty department on 01332 875665 for technical assistance. Please ensure you obtain the model number before calling.
- Please ensure you have read the section not covered under warranty to avoid any unnecessary warranty charges.
- If the problem with the machine can not be resolved please contact the company that supplied you the machine.

(SERVICE CALLS CAN NOT BE PLACED DIRECT WITH PARRY)

NOT COVERED UNDER WARRANTY

- Fault due to poor maintenance.
- Resetting of equipment or circuit breakers.
- Abuse of the equipment
- Foil should never be used on racks
- Blockages eg, drains, condensers, pumps etc
- Lime scale related issues
- Installed incorrectly
- Access arranged for service call and engineer refused access or customer not there.
- No faults with the machine.
- Setting up of equipment eg, dishwasher detergents, levelling and setting up of doors on a 6 burner cooker.
- Excessive carbon build up on griddle plates.
- Over use of lava rock on the chargrills recommended use by Parry 2kg only.
- Faulty electrics – eg, customers plug socket, plug, wiring, junction box fault, wrong fuse.
- Any damages caused by the customer.
- Lamps, glass, door gaskets, Perspex, baskets, knobs all perishable items are not covered.

INSTRUCTION REF: IN101
ISSUE NO. 4
DATE - 21.03.16
Page 18 of 18

All of the above are not covered under our warranty policy. Any costs incurred because of the above will be forwarded to the parties responsible for placing the call.

Failure to pay any warranty charges will result in the customers warranty been put on hold until the bill has been settled.

Any issues regarding the raised charges should be put in writing to our warranty department for further investigation.



Parry Group Ltd
Town End Road
Draycott
Derbsyhire
DE72 3PT