

# INSTRUCTION MANUAL CONVECTION OVENS

Details:

# Index

1. Technical service

---

2. General warnings

---

3. Technical specifications

---

4. Instructions for the installer

---

5. Use instructions (for the user)

---

6. Residual risks (for the user)

---

7. How to use the control panel

---

8. Oven cooking

---

9. Cooking advice

---

10. Routine cleaning and maintenance

---

11. Information for the consumers

---

## 1. Technical service

A technical check-up once or twice a year helps prolong the life of the appliance and guarantees better operation.

Make sure that assistance is carried out solely and exclusively by qualified personnel.

For any spare parts orders or for any information about the appliance, always mention the serial number and model (data indicated on the "technical data" plate at the rear of the oven).

## 2. General warnings

Very important!: keep this instruction book together with the appliance for future consultation.

These warnings were drafted for your safety and for that of others. Please read them carefully before installing or using the appliance:

- If, on receipt of the goods, the **packaging** is damaged, write the following on the delivery note: "I REVERSE THE RIGHT TO CONTROL THE GOODS", specify the damage and get the driver to sign in acceptance; send a claim in writing to the seller within 4 calendar days from the date of receipt. No claim shall be accepted after such period.
- The appliance is intended for professional use and must be utilised by qualified personnel trained to use it.
- Any modification which may be necessary on the electrical system to enable installation of the appliance, must be carried out solely by competent personnel.
- It is dangerous to modify or attempt to modify the characteristics of this appliance.
- Never clean the appliance with direct water jets, because, if any water enters, it could limit the machine's safety .
- Before doing any maintenance or cleaning jobs, disconnect the appliance from the electrical mains and allow it to cool.
- Do not attempt to carry out the periodic controls or any repairs by yourself. Contact the nearest Service Centre and use only original spare parts.

**N.B.:** Improper or incorrect use and failure to observe the installation instructions shall release the manufacture from all responsibility. In this connection, the directives in the "POSITIONING" paragraph must be strictly observed.

### 3. Technical specifications

	Power	Power supply	Temperature	Number of shelves	Trays dimensions	Overall dimensions	Net weight
	watt		°C	n.	mm	mm	kg
<b>Aliseo 4</b>	Mn 3.400 Tf 5.200	230 - 380V /50Hz	25+300	4	600x400 1/1 gastro	815x690 h.570	54
<b>Aliseo 4 Plus</b>	Tf 6.200	380V/50Hz	25+300	4	600x400 1/1 gastro	815x690 h.570	54

The noise level of the appliance in operation is below 70 dB (A).  
The "technical data" plate is positioned on the rear panel of the appliance.

### 4. Instructions for the installer

The following instructions are aimed at the qualified installer, to ensure that he carries out the installation, adjustment and maintenance operations as correctly as possible and according to current legal regulations. Any operation must be performed with electrical power cut to the appliance.

Before using the appliance, carefully remove the special adhesive film protecting the parts in stainless steel. Do not leave any glue residues on the surfaces. If necessary, remove them at once, with an appropriate solvent.

**Fitting the feet** - The feet are inside the appliance and must be secured on the four threaded holes on the base. If necessary, the height of the feet can be adjusted by screwing or unscrewing.

**Positioning** - Position the appliance perfectly horizontally on a table or similar support (the table or support must be at least 85 cm above the floor). Position it at a distance of not less than 10 cm from the side and rear walls, to enable natural ventilating air to circulate freely

around it. The appliance is ventilated through specific openings on the metal walls of the outer housing, and ensures efficiency and long-life. For this reason it is strictly forbidden to obstruct these ventilation openings, even partially or for short periods. **Failure to observe this specific prohibition releases the manufacturer of the appliance from all responsibility and immediately voids any guarantee rights for the said appliance**, because its constructive conformity has been voluntarily compromised. Furthermore, the appliance is not suitable for embedding and for grouped positioning with other identical appliances.

**Electrical connection** - The appliance must be connected to the electrical mains according to current legal regulations. Before making the connection, make sure of the following:

- the voltage and frequency values of the power supply system match the values on the "technical data" plate affixed on the appliance;
- the limiting valve and the system are able to support the appliance's load (see the "technical data" plate);
- the power supply system has an adequate earth connection according to current legal regulations;
- a single-pole switch with minimum between-contacts aperture of 3 mm, sized to the load and conforming to current legal regulations, is fitted between the appliance and the mains in the direct connection to the mains;
- the single-pole switch used for connection is easy to reach when the appliance is installed;
- the yellow/green earth wire is not interrupted by the switch;
- the power supply, when the appliance is operating, must not deviate from the rated voltage value by  $\pm 10\%$ ;
- make sure that after inserting the power supply cord into the terminal block it does not come into contact with any of the cooking range's hot parts.

**Connection to the water mains** - The appliance must be fed with softened drinking water, with hardness from 0.5°F to 5°F (it is obligatory to use a softener to reduce the formation of lime inside the cooking chamber) and pressure in the range from 150 to 250 kPa (1.5 - 2.5 bar).

Connection to the water mains should be made through the threaded 3/4" solenoid-valve on the rear (on the bottom) of the appliance, fitting in between a mechanical filter and an on/off tap (before you connect the filter, allow a certain quantity of water to flow out in order to drain any waste from the pipe).

**Connecting the power cable** - To access the terminal board, just remove the appliance's rear side-panel. Loosen the cable gripper and allow the cable to pass through it. Arrange the conductors so that the earth conductor is the last to detach from its terminal if the cable goes into a state of faulty traction. Connect the **phase** conductors to the terminals marked "L1", "L2" "L3", connecting the **neutral** conductor to the terminal marked "N" and the **earth** conductor to the terminal marked with the symbol  $\equiv$  according to the following lay-out:

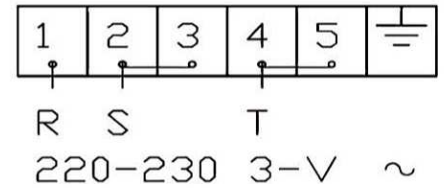
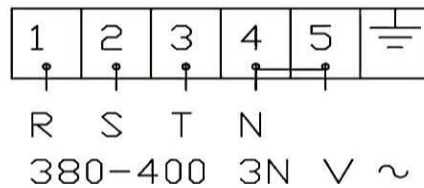
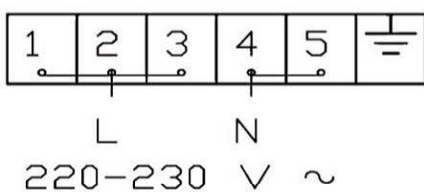

(this electrical connection lay-out is located near the power supply terminal board). Tighten the cable gripper and re-fit the rear side-panel of the appliance.

The appliance must be connected to an **equipotential system** whose efficiency must first be checked according to current legal regulations.

This connection must be made between different appliances by using the appropriate terminal marked with the symbol . The equipotential conductor must have a minimum diameter of 10 mm<sup>2</sup>. The equipotential terminal is at the rear of the appliance.

**Safety thermal breaker** - The appliance has a manually reset safety thermal breaker. It protects against excessive dangerous over-temperatures which could be accidentally generated inside the appliance. If the device is tripped, it interrupts electrical power to the appliance and thus prevents it from operating. To access this device, remove the rear side-panel of the appliance.

## 5. Use instructions (for the user)

For first use, we advise you to let the appliance to run load-free at 250 degrees celcius for about one hour. In this way, any unpleasant smells due to thermal insulation and residual work grease are eliminated.

This appliance must be used solely for the purpose for which it was expressly designed, i.e. cooking foods in the oven. Any other use is considered unsuitable.

The appliance can be used: for all oven cooking of deserts, pizzas, meat, fish, vegetables, as well as for gratinating, and for re-conditioning cooled and frozen foods.

When placing food in the cooking compartment, leave a space of at least 40 mm between pans in order not to over-obstruct air circulation.

Do not use pans with higher than necessary edges: edges are barriers which prevent the circulation of hot air.

Warm up the oven before every cooking operation to obtain maximum uniformity.

Do not salt foods in the cooking compartment.

## 6. Residual risks (for the user)

After a cooking operation, open the door cautiously, to avoid a violent outflow of heat which could cause burns.

While the oven is in operation, pay attention to the hot zones (marked on the appliance) of its external surfaces.

Place the machine on a bench or similar support, at a height of at least 85 cm from the floor.

The bench or support must be able to support the weight of the machine and house it correctly.

The appliance contains electrical parts and must never be washed with a jet of water or steam.





The appliance is electrically connected: before attempting any cleaning operation, cut power to the appliance.

To prevent incorrect connection of the appliance, the relevant electrical and water connections are marked by identification plates.

Do not use the door handle to move the appliance (the glass panel may break).

## 7. How to use the control panel

### Control Panel symbol legend:

- "End of cooking" programming knob / Programmer indicator light	
- Control thermostat knob / Temperature indicator light	
- Grill button / Grill indicator lamp	
- Humidifier knob	
- Line indicator light	

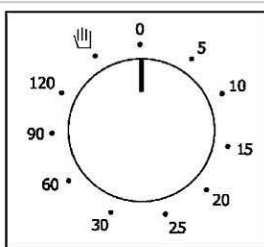

Fig. 1

**Programmer Knob**  
Allows start up of the appliance.

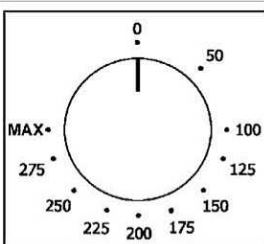



Fig. 2

**Thermo state knob**  
Set the desired temperature in to the cooking chamber.

**Programming cooking time** - To run the oven, turn the programmer knob (Fig. 1) in line with symbol  (continuous operation) or in line with the selected cooking time (up to 120 minutes). In the second case, end of cooking is signalled by the oven switching OFF automatically.

**Programming cooking temperature** - Turn the knob of the adjustment thermostat (Fig. 2) in line with the temperature selected for cooking.

**Control thermostat indicator light** - The control thermostat orange indicator light goes OFF whenever the programmed temperature is reached inside the cooking compartment. It lights up again when the thermostat is tripped to re-establish this temperature.

**"End of cooking" programmer indicator light** - The programmer orange indicator light indicate that the oven is operating and that cooking time is active.



Line indicator light - The green line-indicator light indicates that the oven is electrically connected to the power supply line.

Oven internal light - The light is always on when the oven is operating.

## 8. Oven cooking

For cooking, before putting food in, warm up the oven to the required temperature. When the oven reaches the temperature, put the food in and check cooking time. Switch off the oven 5 minutes before the theoretical time in order to recover stored heat.

### CONVECTION

Convection cooking - Activate the oven and turn the thermostat knob in line with the required temperature.

Defreezing - Activate the oven and turn the thermostat knob to the OFF position

### GRILL

Convection cooking - Activate the oven and turn the thermostat knob in line with the required temperature.

Cooking with the grill - Switch on the oven. Push the button showed in the symbol  and the thermostat knob in line with the required temperature (***IMPORTANT:** grill cooking must be done with the oven door closed*).

Defreezing - Activate the oven and turn the thermostat knob to the OFF position.

### HUMIDIFIER

During operation of the oven to generate humidity in the heated cooking chamber (150-160°C), push the humidifier control button .

## 9. Cooking advice

**Traditional cooking** - Heat is supplied from above and below and, therefore, it is preferable to use the central guides. If cooking requires extra heat from above and below, use the top or bottom guides.

**Convection cooking** - Heat is transferred to the foods by pre-heated air, forced to circulate by in the cooking chamber. The heat quickly and uniformly reaches all parts of the chamber, enabling simultaneous cooking of different types of food (providing they have the same cooking temperature), placed on the shelves without mixing tastes and smells. Convection cooking is particularly convenient for rapid de-freezing, and for sterilising preserves and drying mushrooms and fruit.

**Cooking with the grill** - Grilling is effected by the thermal radiation of an incandescent electrical heating-element. The temperature produced by the infra-red rays is very high and one-way (downward from above), and, therefore, food surfaces are immediately browned.

**Cooking with the ventilated grill** - Forced circulation of air is combined with thermal radiation produced by the grill, and this allows heat to gradually penetrate the inside of the food without burning the surface.

**Cooking desserts** - Desserts require a very high temperature (usually from 150 to 200°C) and a pre-heated oven (about ten minutes). The oven door must not be opened until at least 3/4 of the cooking time has elapsed. Whipped dough must be difficult to detach from a spoon because excessive fluidity would prolong cooking time to no avail.

**Cooking meat and fish** - Meat to be cooked should weight at least 1 Kg to prevent it drying too much. Very tender red meats to be cooked rare, which must be cooked on the outside to keep all their gravy, require short cooking time at high temperature (200-250°C). The gravy ingredients must be placed immediately in the pan only if the cooking temperature is brief, otherwise they should be added during the last half-hour. You can check the degree of cooking by squashing the meat with a spoon: if the meat does not yield, it is correctly cooked. For roast beef and fillet, which must remain pink inside, cooking time must be very brief. Meats may be placed on a plate suitable for oven cooking or directly on the grill, under which you should place a tray to collect the gravy. When cooking has finished, we advise you to wait for 15 minutes before cutting the meat so that the gravy does not come out. Before being served, the dishes may be kept hot in the oven at minimum temperature.

**Grilling** - Almost all meats may be grilled, with the exception of some lean game meats and meat loaves. Apply a little oil on the meat or fish to be cooked and always place them on the grill - put the grill in the guides nearest or furthest from the grill heating element in proportion to the meat, in order to avoid burning the surface and cooking the inside insufficiently. It is useful to place a tray under the grill to collect drops of gravy and fat.

## 10. Routine cleaning and maintenance (WARNING: Cut power to the appliance before every operation)

**General cleaning** - Clean the oven when it is cold. Wash enamelled parts with lukewarm water and soap, do not use abrasive products, steel wool, or acids, which could ruin them. To clean the steel parts, do not use products containing chlorine (sodium hypochlorite, hydrochloric acid, etc) even if diluted. Use specific off-the-shelf products or a little hot vinegar. Rinse thoroughly with water and dry with a soft cloth. Clean the glass door of the oven with hot water only, and do not use rough cloths. Do not allow foods (especially acid foods such as salt, vinegar, lemon, etc) to stagnate on the stainless steel parts, because they could deteriorate. Do not wash the appliance with direct jets of water, because if water enters, this could limit the appliance's safety. Do not use corrosive substances (e.g. hydrochloric acid) to clean the oven's support bench.

**Cleaning the oven** - It is good practice to clean the oven interior at the end of every day of duty. In this way it will be easier to remove cooking residues, preventing them from burning when the oven is next used. Clean it accurately with hot water and soap or with the appropriate off-the-shelf products.

**Cleaning the oven door** - To clean the oven door thoroughly, proceed as follows:

- fully open the door;
- attach the rings "A" onto the hinge seats (Fig. 4);
- lift the door gently and withdraw it (Fig. 5).

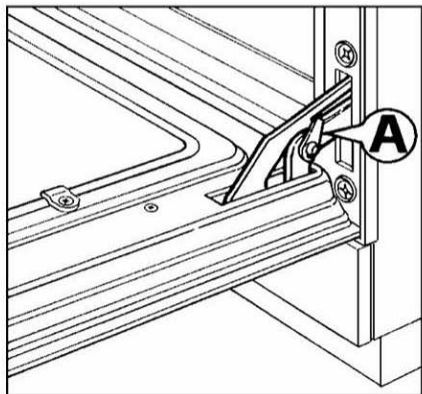

Fig. 4

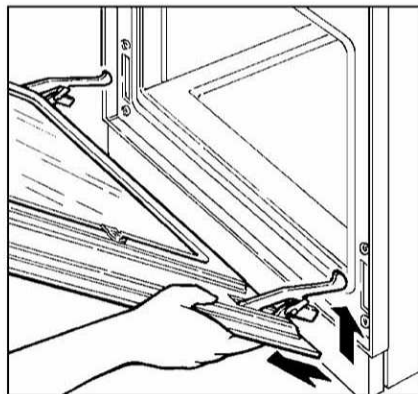

Fig. 5

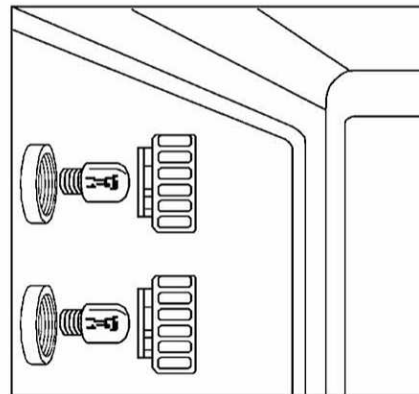

Fig. 6

**IMPORTANT** - To refit the door after cleaning, repeat the procedure in reverse order. Take special care to simultaneously insert the hinges in their seats on the cooking chamber, to avoid damaging the door microswitch.

**Replacing oven lamp** - Electrically switch off the appliance; unscrew the protective glass cap (Fig. 6); unscrew the lamp and replace it with another lamp suitable for high temperatures (300°C), with the following characteristics:

- Voltage 230/240 V
- Power 25 W
- Fitting E 14

Refit the glass cap and power up the appliance.

## 11. Informations to the consumers

Further to Directive 2002/96/EC, the symbol of the crossed rubbish skip on the appliance means that at the end of its life, the product must be disposed of separately from the other rubbish. The user must hand the appliance to a specialised waste collection centre for electric and electronic equipment.

The separate collection of the rubbish and subsequent treatment, recovery and disposal help to produce other equipment using recycled materials, reducing the negative effects on the environment and public health, which would be caused by incorrect management of the rubbish.

Should the user dispose of the product abusively, administrative sanctions would be applied pursuant.

