

Metcalfe Slicers

NS300XHD, NS350XHD & NS370XHD

Extra Heavy-Duty Gravity Feed Slicers
(Gear Driven)

Installation, Operating Instructions



Model Shown NS300XHD (Left) & NS350XHD (Right)



Model Shown NS370XHD

Index

Your Slicer.....	2
NS300XHD - Technical Data Sheet.....	3
NS350XHD - Technical Data Sheet.....	4
NS370XHD – Technical Data Sheet.....	5
Optional Extras.....	6
Installation.....	7
Unpacking.....	7
Installation.....	7
Operation.....	7
Cleaning Instructions.....	8
Disassembly & Cleaning.....	8
Reassembly after Cleaning.....	9
Removing the Knife.....	9
Sharpening the Knife.....	10
When & How Often To Sharpen Knife.....	10
Preparing for Sharpening.....	10
Sharpening the Knife.....	10
Slicer Safety Tips.....	11
Suitable Product for Slicing.....	11
Troubleshooting.....	12
Maintenance.....	12
Breakdown Drawing & Part List.....	13
Spares & Service Contact Details.....	14
Warranty Terms.....	15
Notes.....	16 - 18
Electrical PAT Test Certificate.....	19

Your Slicer

Sharpening Attachment

Table

Perspex Guard

Knife Scraper

Centre Plate Spindle Knob

Lubricating Point

On & Off Switches

End Device Handle

Knife

End Device

Fence Plate

Centre Plate

Bottom Runner Handle

Bottom Runner

Indicator Knob

Bottom Runner Knob

Rubber Feet

(Image may differ to actual slicer)

Metcalfe NS300XHD – Extra Heavy Duty (12 Inch)

Features

- High quality, gravity feed slicer
- Hollow ground chromed carbon steel blade
- Designed to effortlessly handle heavy loads like bacon and large pieces of meat that might cause slipping and/ or blade stoppage on a belt driven machine.
- Transparent slicing guard to ensure ultimate user safety whilst slicing
- Easy set thickness control, cuts from 0 to 14mm for precision cut
- Bottom runner slides on ball bearings for smooth glide
- Entirely detachable for easy cleaning
- CE Approved
- Large base to ensure slicer has a large capacity to cope with large products
- Built-in, self-aligning sharpening and de-burring unit
- Table, Bottom Runner, Centre Plate, Knife and Sharpening unit are detachable for easy, safe cleaning

Technical Specifications

Model	Weight	Blade Diameter	Electrical Supply	Motor (Kw)	Dimensions (mm) D x W x H
NS300XHD	34 Kg	300 mm	220 / 240V 50Hz	0.300	560 x 680 x 610

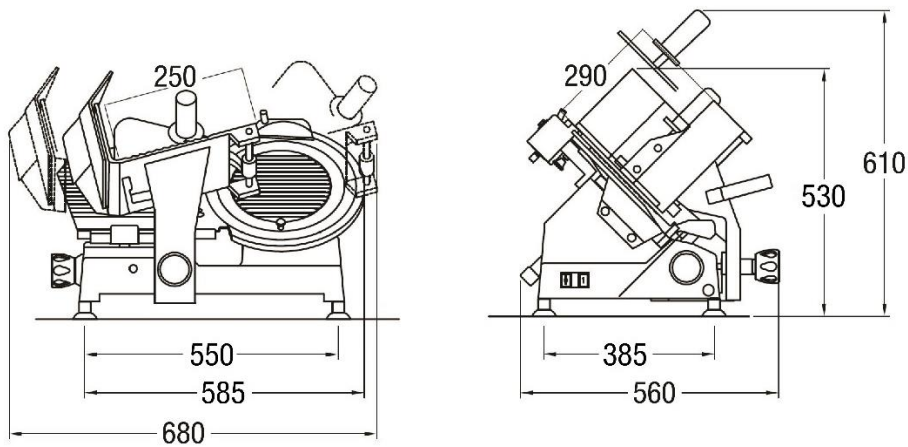

Dimensions

A – Feet Distance	550 mm
B – Footprint Cut	585 mm
C – Max. Distance Beginning / End Movement	680 mm
D – Feet Distance	385 mm
E – Max. Width Distance	560 mm
F – Height	530 mm
G – Max. Height Distance	610 mm
H – Table Length	250 mm
I - Table Width	290 mm

Metcalfe NS350XHD – Extra Heavy Duty (14 Inch)

Features

- High quality, gravity feed slicer
- Hollow ground chromed carbon steel blade
- Designed to effortlessly handle heavy loads like bacon and large pieces of meat that might cause slipping and/ or blade stoppage on a belt driven machine.
- Transparent slicing guard to ensure ultimate user safety whilst slicing
- Easy set thickness control, cuts from 0 to 14mm for precision cut
- Bottom runner slides on ball bearings for smooth glide
- Entirely detachable for easy cleaning
- CE Approved
- Large base to ensure slicer has a large capacity to cope with large products
- Built-in, self-aligning sharpening and de-burring unit
- Table, Bottom Runner, Centre Plate, Knife and Sharpening unit are detachable for easy, safe cleaning

Technical Specifications

Model	Weight (kg)	Blade Diameter	Electrical Supply	Motor (Kw)	Dimensions (mm) D x W x H
NS350XHD	41 Kg	350 mm	220 / 240V 50Hz	0.300	560 x 700 x 640

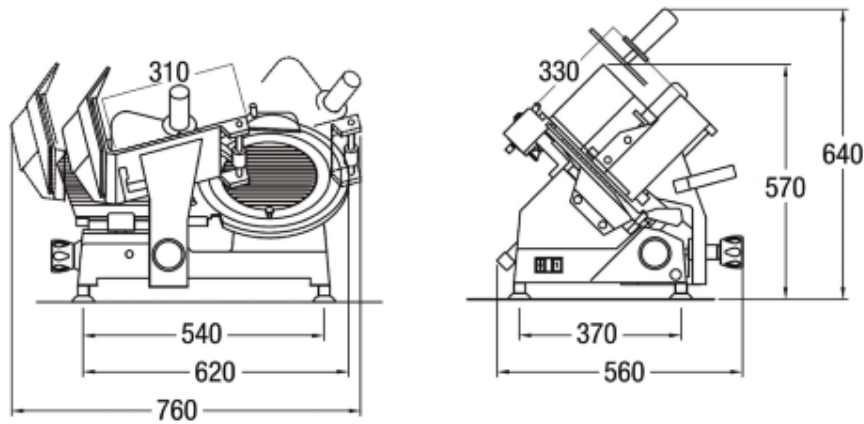

Dimensions

A – Feet Distance	550 mm
B – Footprint Cut	610 mm
C – Max. Distance Beginning / End Movement	700 mm
D – Feet Distance	385 mm
E – Max. Width Distance	560 mm
F – Height	530 mm
G – Max. Height Distance	640 mm
H – Table Length	280 mm
I - Table Width	325 mm

Metcalfe NS370XHD – Extra Heavy Duty (15 Inch)

Features

- High quality, gravity feed slicer
- Hollow ground chromed carbon steel blade
- Designed to effortlessly handle heavy loads like bacon and large pieces of meat that might cause slipping and/ or blade stoppage on a belt driven machine.
- Transparent slicing guard to ensure ultimate user safety whilst slicing
- Easy set thickness control, cuts from 0 to 13mm for precision cut
- Bottom runner slides on ball bearings for smooth glide
- Entirely detachable for easy cleaning
- CE Approved
- Large base to ensure slicer has a large capacity to cope with large products
- Built-in, self-aligning sharpening and de-burring unit
- Table, Bottom Runner, Centre Plate, Knife and Sharpening unit are detachable for easy, safe cleaning

Technical Specifications

Model	Weight (kg)	Blade Diameter	Electrical Supply	Motor (Kw)	Dimensions (mm) D x W x H
NS370XHD	44 Kg	370 mm	220 / 240V 50Hz	0.37	695 x 825 x 690

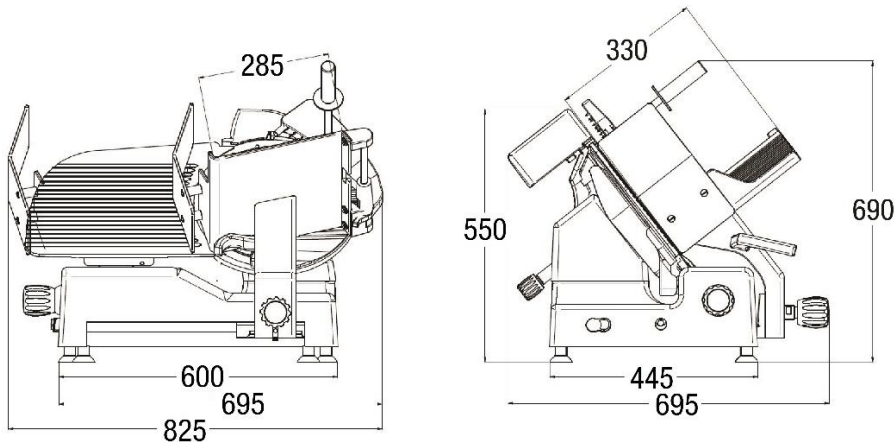

Dimensions

A – Feet Distance	600 mm
B – Footprint Cut	695 mm
C – Max. Distance Beginning / End Movement	825 mm
D – Feet Distance	445 mm
E – Max. Width Distance	695 mm
F – Height	550 mm
G – Max. Height Distance	690 mm
H – Table Length	285 mm
I - Table Width	330 mm

NEW!!

Optional Extras



Teflon Coated Parts, 20% Increase in gliding property



Special stainless steel handgrip



Aluminium Knobs Kit

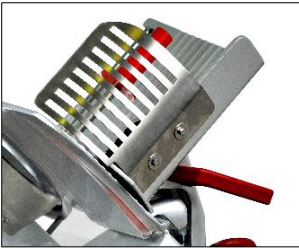

Stainless Steel Guard

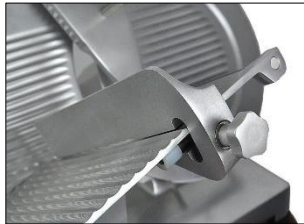

Product Hold Bar for Gravity Plate



Serrated Blade



Tray Extension Device

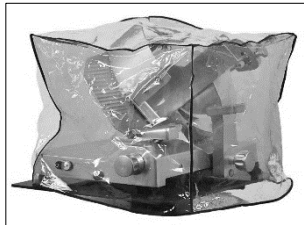

Plastic Cover

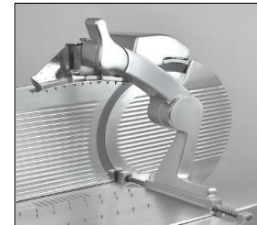

Special Arm (Protected)



Stainless Steel Knife Remover

Painting Customisation



(For more information and prices please contact the sales department for more info).

Installation

Unpacking

Unpack the slicer immediately after receipt. Please inspect the slicer to ensure, there is no damage and that all parts are included i.e. Knobs, Feet and Knife Removing Tool. If the machine is found to be damaged, keep all the packaging and contact us or contact your source of the equipment immediately.

You should receive with your slicer:

- 1 x Metcalfe Tasteless Oil
- 1 x Flat Head Screwdriver
- 1 x This Instruction Manual
- 1 x Knife Removing Tool

If any of the above items were not received with your slicer, please refer to page 14 for contact details and inform us immediately for replacements.

Please ensure that you complete the product information section on page 14.

Installation

1. Read this manual thoroughly before installation and operation. DO NOT proceed with any installation nor operation if you have any questions or do not understand anything in this manual. Please see Metcalfe Catering Equipment Ltd contact details on page 15 to resolve any queries you may have.
2. Make sure to clean and sanitise the entire slicer before use. (see Cleaning Page 8)
3. Select a location for the slicer that is level, smooth, solid, dry, non-skid and suitable to withstand the weight of the slicer plus the food to be sliced.

Operation

1. Ensure the slicer is turned off and that the indicator knob is set to "0".
2. Pull back the carriage completely (towards the operator) to the loading position.
3. Lift up the end device into the rest position.
4. Place product onto the table, the product will press against the fence plate because of its weight. Block it with the end device by lowering it onto the product and pressing down slightly.
5. Rotate the indicator knob counter clockwise to the desired setting of cut.
6. Turn the slicer on by pushing the start button. Power indicator light, which is located between the on / off switch, will illuminate.



DO NOT hold the food product with your hand. Never put your hand on or around the table while the slicer is on. The table handle is the only part of the slicer you should touch while slicing.

7. Use the table handle to manually push the carriage back and forth. The table handle is the only part of the slicer you should touch while slicing. DO NOT catch slices with your hands, let slices drop onto the receiving area.
8. When the weight or size of the product does not allow a proper slice for reasons of weight, use the end device handle and apply some pressure to the product.



If a product needs to be adjusted during slicing, ALWAYS pull the carriage all the way towards you. Turn the slicer off, and pull the table all the way towards you.

9. After the last slice stroke, pull the carriage all the way towards you. Turn the slicer off by pressing the stop button, the power indicator light will go out. Turn the indicator knob clockwise until it stops to close the slicer table.
10. You can now unload or load the product from the table.

Cleaning Instructions

Daily cleaning should be considered mandatory for all equipment used in the preparation of food. When using a meat slicer and with the possibility of cross contamination, these units should be cleaned before slicing each new product. Once your slicer makes contact with any food product, the entire slicer, including removable parts must be thoroughly cleaned. This process is to be repeated at the end of each working day. If the machine has not been used for a while it must be cleaned before use as well. In order to ensure the slicer is cleaned properly and to avoid damage, the instructions below should be followed.

Disassembly & Cleaning

1. Turn slicer off and unplug from mains.
2. Turn the indicator knob clockwise past "0" until it stops so the fence plate covers the blade (Figure A).
3. With the indicator knob on "0" pull back the carriage all the way to the left (Figure A).

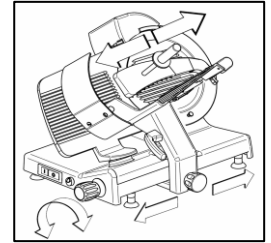

(Figure A)

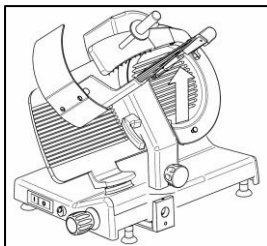

(Figure B)

4. Turn the bottom runner knob counter-clockwise all the way while supporting the carriage, once fully unscrewed lift the whole of the table and carriage from the machine (Figure B).

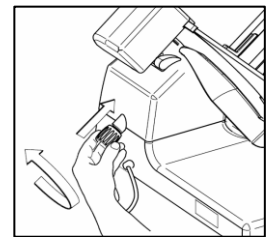

(Figure C)

5. Unscrew the centre plate spindle knob (counter clockwise) and remove from the rear of the machine (Figure C).

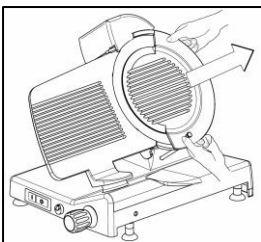

(Figure D)

6. Once the centre plate spindle has been undone take the centre plate spindle out of the machine and lift the centre plate using the knob locate at the bottom (Figure D).

7. Remove the knife sharpener by loosening the screw at the rear of the sharpener (about 10 turns), then pull it upwards from the slicer. (Figure E)



(Figure E)

8. Remove the knife scraper by sliding it to the left (Figure F).
9. Only use warm water and a mild detergent to clean all parts.

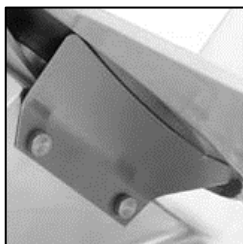

(Figure F)

10. Rinse all parts after cleaning with clean water and dry with a soft cloth.

11. To clean the knife use a damp cloth on the blade and move it slowly from the centre outwards to the edge (Figure G). Dry the knife in the same way.

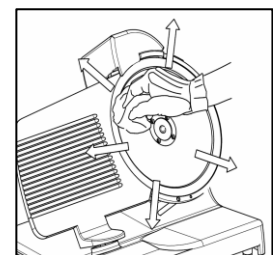

(Figure G)

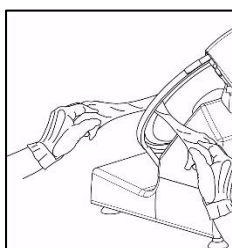

(Figure H)

12. To clean the back knife guard pass a damp cloth between the blade and the back knife guard (Figure H).

Reassembling After Cleaning

After cleaning the knife, the rest of the slicer must also be fully cleaned and dry before reattaching slicer parts and using the slicer

1. Insert the knife scraper over pins and slide back into position (Figure A).

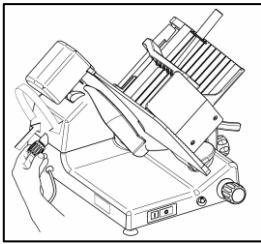

(Figure B)

2. Insert the centre plate spindle completely and rotate clockwise to secure (Figure B).

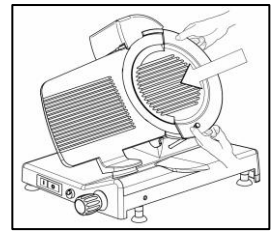

(Figure A)

3. Insert the centre plate over the knife and ensure that the grooves are flush with the grooves on the fence plate.

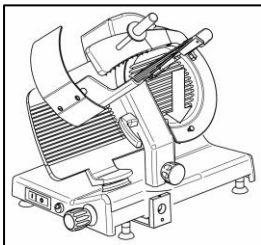

(Figure D)

4. Insert the carriage (Figure D) and tighten the bottom runner knob (Figure E).

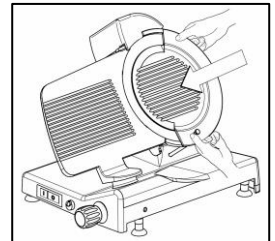

(Figure C)

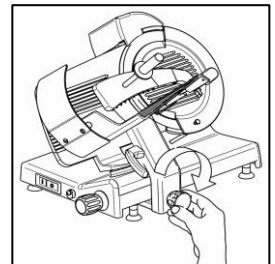

(Figure E)

5. Check that the bottom runner moves freely from left to right (Figure F).
6. Check that the indicator knob works correctly (Figure F).

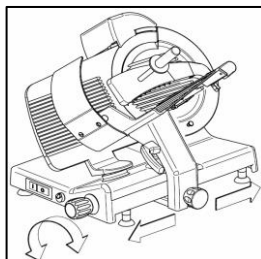

(Figure F)

Removing the Knife

1. Switch off and unplug from mains.
2. Unscrew the centre plate spindle (counter clockwise) and remove from the rear of the machine.
3. Remove the centre plate.
4. Fit the knife removing tool over the knife, and secure it by tightening the two knobs.
5. Once the knife removing tool is secure loosen the four screws securing the knife to the pulley.
6. Pull off the knife removing tool with the knife **ALWAYS REMOVE HOLDING THE KNOBS**.
7. Proceed to clean machine.
8. Place the knife removing tool and knife back onto the slicer and follow the above steps in reverse.

Sharpening the Knife

Preparing for Sharpening

1. Ensure the slicer is switch off.
2. Rotate the indicator knob (1) clockwise until it stops and the slicer fence plate covers the blade and turn the slicer off (2) as shown in (Figure A).
3. Clean and dry both sides of the knife before sharpening. Please refer to cleaning instructions on page 8.

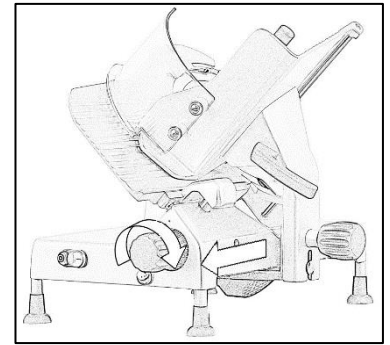

(Figure A)

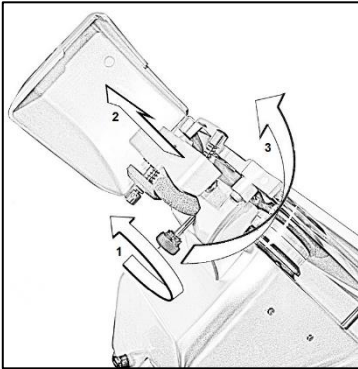

4. Lift the cover up and loosen sharpener release knob (1) by turning it counter clockwise several times.
5. Once the sharpener is loose lift and rotate the sharpener (2 & 3) and lower it into position with the knife fitting between the two stones.
6. Tighten sharpener release knob (1) to secure sharpener.

Sharpening the Knife – (Regular Procedure)

1. Plug in and select the start button on the slicer.
2. Push the sharpening stone button (4) and honing stone button (5) at the same time so that both stones make contact with Knife. Maintain pressure on the buttons for 5-10 seconds.

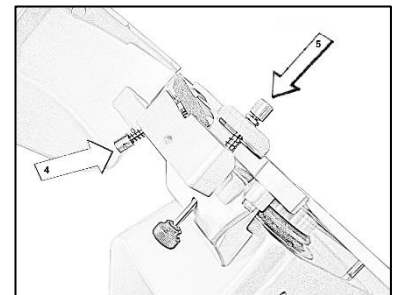

TURN SLICER OFF before inspecting.

Sharpening the Knife (Extended Procedure)

NOTE: Use the extended procedure only if the regular sharpening procedure does not produce satisfactory results.

1. Start slicer
2. Push sharpening stone button (1) so the stone sharpens the back side of the knife. Maintain pressure on button for 30 seconds.
3. Push sharpening stone button (1) and honing stone button (2) at the same time so both stones make contact with the knife. Maintain pressure on the buttons for 5 seconds.

TURN SLICER OFF before inspection.

After Sharpening

1. Turn slicer off and unplug power cable.
2. Loosen sharpener release knob (Figure A).
3. Lift and rotate sharpener and place back in its stored position (Figure B)
4. Tighten sharpener release knob (Figure A).
5. Clean the entire slicer. Refer to cleaning on page 8.
6. Reinstall food bottom runner and plug power cable in.

Slicer Safety Tips

To Avoid Serious Personal Injury:

- **NEVER** touch the slicer without training and authorisation from your supervisor or if you are under the age of 18. Read this instruction manual first.
- **ONLY** install the slicer on a level non-skid surface that is non-flammable and is located in a clean, well-lit work area and away from children and visitors.
- **NEVER HOLD THE FOOD PRODUCT WHILE SLICING.** Hold only the end device handle while slicing.
- **BEFORE CLEANING, SHARPENING, SERVICING, OR REMOVING ANY PARTS** always turn the slicer off, turn the indicator knob clockwise until it stops and unplug power cable.

To Avoid Serious Personal Injury:

- NEVER touch rotating knife
- ALWAYS keep hands clear of all moving parts
- ALWAYS turn slicer off, turn the slicer indicator knob clockwise until it stops.

Important Cleaning Notes

- Never use steel wool pads on the slicer
- Do not use other metal products to scrape or remove stubborn deposits of sliced product.
- Never leave any leftover product on the slicer (Clean At least Once a Day).
- DO NOT clean the unit, or any parts of the unit, in a dishwasher.
- Never place the power cord over the unit.

Suitable Products for Slicing

The following are products that can be sliced:

- All types of cold cuts (cooked, raw, smoked)
- Boneless meat (cooked or raw at a temperature of no lower than +3°C)
- Bread and cheese (those that can be sliced, such as Gruyere, Fontina, etc.)

The following are products that cannot be sliced because they could cause damage to the machine:

- Frozen food (Only with Serrated Blade see page 6)
- Deep-frozen food
- Food with bones (meat & fish)
- Vegetables
- Any other products not meant for consumption

Troubleshooting

If the slicer is not working correctly please check the list below before contacting an engineer or Metcalfe Catering Equipment Ltd.

Problem	Possible Causes	Action Required
Pressing the start button the machine does not start.	No electricity.	Check that the plug is correctly inserted.
Pressing the start button the machine starts but the working light does not come on.	Light is defective.	Do not use the machine if the light does not work. Contact service for assistance.
The machine starts but the motor heats up too much, and gives off a bad odour.	Defective motor.	Do not use the machine. Contact service for assistance.
The machine vibrates.	Defective transmission.	Contact service for assistance.
Excessive resistance in cutting the product.	The blade is not sharp.	Sharpen the blade.
The blade slows or stops under stress.	Loose belt	Contact service for assistance.
Sharpening is no longer regular.	Sharpening stones are excessively dirty. Sharpening stones worn out.	Clean the sharpening stones. Replace sharpening stones. Contact service for assistance.
The sliced product is frayed and irregular.	The blade is not sharp.	Sharpen blade.
	The blade is excessively used.	Replace the blade. Contact service for assistance.
The machine does not stop when the button is pressed.	Control circuit is defective.	Pull out the plug to stop the machine immediately and contact service for assistance.

If the problems persist and the assigned solution does not remedy the problem, please see page 14 and call our Service Department.

Maintenance

Only the below maintenance is recommend for the operator to carry out, all other maintenance should be done by an approved engineer.

- Knife sharpening.
- Lubrication of the bottom runner guide bars and end device (weekly).
- Check the condition of the electrical cable and the cable gland on the base of the machine (periodically).
- Replacing the knife.
- Replacing the sharpening stone.

Maintenance to be carried out by engineer only.

- Replacing the components of the electrical system under the base.
- Repairing the structural parts, repairing and/ or replacing components under the base.

Breakdown Drawing & Parts List

To obtain a copy of the breakdown drawing & parts list relating to any of the below slicers. Please either email enquires@metcalfecatering.com quoting the model no of the unit as shown on page 14. Alternatively you can scan the below QR codes using a QR Scanner to download them directly to your phone or tablet.

- **Metcalfe NS300XHD**



- **Metcalfe NS350XHD**



- **Metcalfe NS370XHD**



To download a QR Scanner to your mobile / table click on either of the below to obtain the QR Reader application (only if viewing as a PDF).

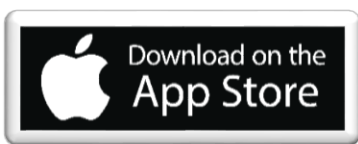

Or go to your app store and search for the below

Apple Device

QR Code Reader by Scan

Windows

QR Code Reader

Android

QR Code Reader

(If any hyperlink is damaged please inform us at martyn@metcalfecatering.com)

Spare Parts and Service

For more information on Metcalfe Spares / Accessories and Service Support, please contact us always quoting the Metcalfe Serial Number of the machine. This can be found on the serial number plate which is shown below also the location as to where it can be found on the machine.

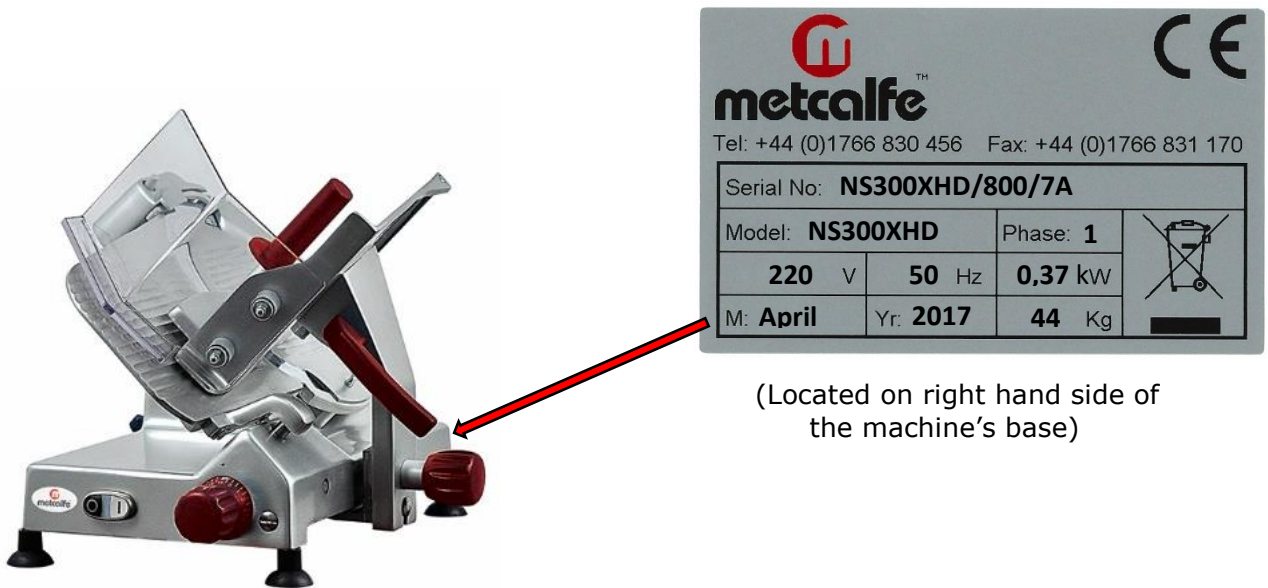

(Located on right hand side of the machine's base)

Contact us on the details below;

Metcalfe Sales & Spares Dept.

Tel: 01766 830 456 - Opt 1
Email: enquires@metcalfecatering.com

Metcalfe Service & Repair Dept.

Tel: 01766 830 456 - Opt 4
Email: karen@metcalfecatering.com

Additional copies of either the instruction manual or breakdown drawing for this unit can be obtained by visiting the Metcalfe Catering Equipment Ltd website or contacting sales department.

Web-site: www.metcalfecatering.com / Sales e-mail: sales@metcalfecatering.com

Product Information

Please complete the below details and keep in a safe place. Ensure that you complete the Model No & Serial No sections for future reference when enquiring for spare parts and technical help.

Please see above for location of serial no on the Metcalfe data plate, the model no for your unit will be the first section of the serial no as shown on the above plate.

Metcalfe Catering Equipment Ltd

Company Name: _____

Company Address: _____

Model No: _____ Serial No: _____ Date of Purchase: _____

Name of Dealer: _____

Please retain this section for your records

Metcalfe Warranty

All Metcalfe products are guaranteed against defects in material and workmanship for a period of two year from date of Invoice, except where specially noted.

The Company's obligation under this warranty is limited to repairing or replacing, without charge, any part or parts found to be defective under normal use, in accordance to the specified operations manual and capacity ratings.

On all return to factory warranty items, it is the responsibility of the purchaser to return the entire unit to the factory, in a clean condition, properly packed and labelled.

All repairs, alterations or replacement of materials or parts not authorised by Metcalfe will automatically void all warranties in their entirety.

There is a limited **6-month warranty** on the following:

- Mixer attachments (beater, whisk and dough hook)
- Parts purchased or supplied for the repair of Metcalfe equipment

This warranty does not cover the following:

- Failure due to neglect, abuse, careless handling or misuse of machine
- Failure caused due to improper maintenance
- Blender clutches
- Knives and gears on can openers
- Sharpening of slicer blades
- General wear and tear

Metcalfe and its suppliers reserve the right to make changes in design and specification to any product without prior notification.



Electrical PAT Certificate

Test Details	Result
Item:	
Class:	Class 1 / Class 2
Date:	/ /
Appliance ID:	
User ID:	M.C.E
Visual:	
Earth Current: amps	
Class 1: Earth Result / RPE	Ω
RISO:	M Ω
1 EA:	MA
Class 2 RISO:	M Ω
1 EA:	MA
Insulation (500V):	M Ω
Load:	KVA
Leakage:	MA
Polarity (leads only):	

Test Details	Result
Item:	
Class:	Class 1 / Class 2
Date:	/ /
Appliance ID:	
User ID:	M.C.E
Visual:	
Earth Current: amps	
Class 1: Earth Result / RPE	Ω
RISO:	M Ω
1 EA:	MA
Class 2 RISO:	M Ω
1 EA:	MA
Insulation (500V):	M Ω
Load:	KVA
Leakage:	MA
Polarity (leads only):	

Electrical PAT Certificate

Test Details	Result
Item:	
Class:	Class 1 / Class 2
Date:	/ /
Appliance ID:	
User ID:	M.C.E
Visual:	
Earth Current: amps	
Class 1: Earth Result / RPE	Ω
RISO:	M Ω
1 EA:	MA
Class 2 RISO:	M Ω
1 EA:	MA
Insulation (500V):	M Ω
Load:	KVA
Leakage:	MA
Polarity (leads only):	

Test Details	Result
Item:	
Class:	Class 1 / Class 2
Date:	/ /
Appliance ID:	
User ID:	M.C.E
Visual:	
Earth Current: amps	
Class 1: Earth Result / RPE	Ω
RISO:	M Ω
1 EA:	MA
Class 2 RISO:	M Ω
1 EA:	MA
Insulation (500V):	M Ω
Load:	KVA
Leakage:	MA
Polarity (leads only):	