

Model: SF-104S-2 Digital Temperature Controller

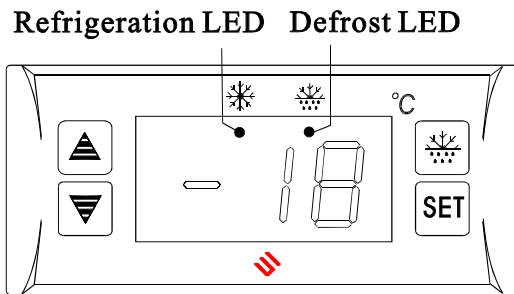

Features of Function

- Super-thin, water-proof, with outer high-voltage parts, easy & convenient to fix the compressor of one HP.
- Temperature Display/ Temperature Control/ Evap. Fan Control/ Value Storing/ Self Testing

Specifications

1. Output of the outside sealed transformer: AC12V (one transformer matched with one temp. controller)
2. Temperature sensor: NTC, 2m(L)
3. Range of temperature displayed: $-45 \sim 150^{\circ}\text{C}$ Accuracy: $\pm 1^{\circ}\text{C}$
4. Range of set temperature: $-45 \sim 99^{\circ}\text{C}$ Factory default: 4°C
5. Panel dimension: 77(Length) \times 35(Width) \times 30(Depth)mm
Mounting hole dimension: 71(Length) \times 29(Width)mm
6. Temperature of the operating environment: $-10 \sim 60^{\circ}\text{C}$
Relative Humidity: 20% ~ 90% (Non-condensing)
7. Relay output contact capacity:
 - Compressor: N.O. 30A/250VAC
 - Evap. Fan: N.O. 30A/250VAC

Front Panel Operation

1. Set temperature
 - Press **SET** button, the set temperature is displayed.
 - Press **▲** or **▼** button to modify and store the displayed value, Press **SET** button to exit the adjustment and display the cold room temperature.
 - If no more button is pressed within 10 seconds, the cold room temperature will be displayed.
2. Refrigeration LED: During refrigeration, the LED is on; When the cold room temp. is constant, the LED is off; During the delay start, the LED flashes.
3. Defrost LED: during defrosting, the LED is on; When the cold-room temp. is constant, the LED is off; During the delay start, the LED flashes.
4. Manually start 1 stop defrost: pressing **SET** & **☄** buttons simultaneously for 6 seconds can start or stop defrost.
5. Parameter setup
 - Press **SET** button and hold for 6 seconds to enter the parameter setup mode while E1 flashes.
 - Press again **SET** button to select sequentially from the parameters: E2, E3, E4, E5, E1.
 - Press **▲** or **▼** button, the value of parameter will be displayed and can be modified and stored.
 - If no more button is pressed within 10 seconds, it will return to normal operation mode.

Parameter	Function	Set range	Default
E1	Lower setpoint limit	$-45^{\circ}\text{C} \sim \text{Set temp.}$	2°C
E2	Higher setpoint limit	$\text{Set temp.} \sim 99^{\circ}\text{C}$	8°C
E3	Temp. hysteresis	$1 \sim 20^{\circ}\text{C}$	4°C
E4	Comp. start delay time	$0 \sim 10\text{Min}$	0Min
E5	Offset on room temp.	$-10 \sim 10^{\circ}\text{C}$	-1°C

6. The factory default resumption: press **▼** button and **▲** button simultaneously for 6 seconds, the indicator flashes, all parameters will be resumed as same as factory defaults. After 10 seconds, it returns to the normal operation.

7. Lock parameters:





In normal operating, press  button and hold for 10 seconds to lock the parameters if "OFF" is displayed, or to unlock if "ON" is displayed. Parameter can be displayed only and not be modified if locked, but the adjustment of the set temp. is active. (the factory default is "ON")

Function details

1. Temperature Control

- After turning on for the delay time, the compressor starts operating and evap.fan starts operation after 3 seconds delay time when cold-room temperature \geq (set temperature+ hysteresis), and will be off when cold-room temperature \leq set temperature.
- To protect the compressor, it can re-start unless the time when the compressor stops every time is longer than the delay time (Parameter E4).

2. Timing defrosting by turning off

- After operating for a defrosting period (parameter F2), it enters turning-off state automatically, the compressor stops and evaporation fan operates; it enters automatic temperature control state after certain time (Parameter F1).
- When parameter F4=1, the cold-room temperature is locked during defrosting, the temperature in defrosting start is displayed. After defrosting, the cold-room display will be resumed normal after displaying delay parameter F6 (or reach control temperature).
- When the duration of defrost is set to "00", the function of automatic defrost will be cancelled.
- press  and  button simultaneously and hold for 6 seconds to enter the parameter setup mode while F1 flashes. Press again  button to select F2, F4, F6, F1. Press  or  button, the value of parameter will be displayed and can be modified and stored.
- If no more button is pressed within 10 seconds, it will return to normal operation mode.

Parameter	Function	Set range	Default
F1	Max. Defrost duration	1~90Min	18Min
F2	Defrost interval time	0~24Hr	6Hr
F4	Display during defrost	0=Normal display 1=Last value before defrost	1
F6	The temp.display delay time after defrost	0~30Min	10Min

3. Abnormal work mode

When room sensor is short circuited or overheated (more than 150°C) "HH" is displayed; When room sensor is open circuited or temperature is too low (less than -45°C) "LL" is displayed. At that time the compressor enters timing operation mode automatically by the cycle of 45 minutes on and 15 minutes off.

4. Circuit Diagram

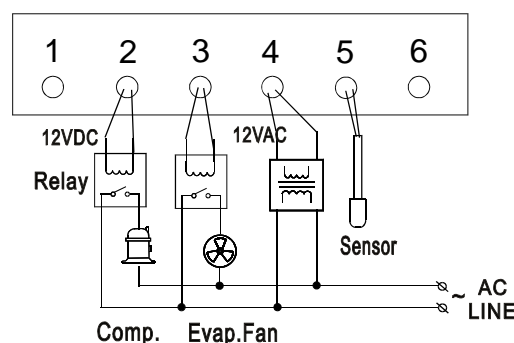

Notes for Installation

1. Sensor leads must be kept separately from main voltage wires in order to avoid high frequency noise induced. Separate the power supply of the loads from the power supply of the controller.
2. When installation the sensor shall be placed with the head upward and the wire downward; The evaporator sensor must be installed between the fins of the evaporator in the area, where probably the ice is the thickest.
3. The temperature controller can not be installed in the area with water drops.

Accessories for the temperature controller

1. One attached transformer and two relays
2. One temperature sensor