



ÖZTİRYAKİLER

Cumhuriyet Mah.Hadımköy Yolu Cad.No:8

Büyükcçekmece-İstanbul-TURKEY

e-mail: export@oztiryakiler.com.tr

web: www.oztiryakiler.com.tr

code:

900 SERIE

model:

7855.N1.10908.07

ELECTRICAL RECTANGULAR BOILING PAN 250 lt INDIRECT HEAT

OTEI 250

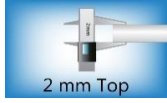

2 mm Top



Flush Top



Heavy Duty

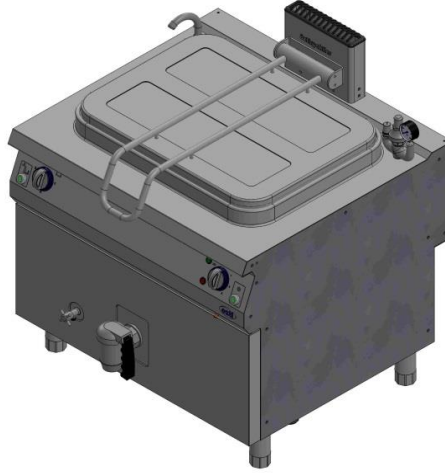

Easy Maintenance



Efficiency



Hygiene

900 SERIE MAIN FEATURES

- * 2 mm thick AISI 304 stainless steel laser cut top
- * Flush top setting with secure fixing screws
- * 3 installation options; standalone(fixed on a base w/ or w/o door), cantilever or on concrete plinth
- * Installation gap behind the equipment for plumbing & electrical connections
- * Easy access from front panel to all major components for maintenance
- * Modular system for flexibility

CONSTRUCTION

- * All stainless steel construction to avoid any infiltration
- * Top, sides, back, front panels and control consoles in stainless steel with satin scotch-brite finish
- * Standalone and base units are equipped with heavy duty 150 mm adjustable stainless feet.

ELECTRIC BOILING PAN

- * Indirect heating system
- * Rectangular monoblock boiling pan suitable for cooking and poaching
- * Double skin lid with counter balanced mechanism for easy opening
- * High quality thermal insulated external jacket for energy saving
- * Energy regulation with electronic gas valve
- * 2" chrome-plated draining valve with large athermic handle
- * Solenoid valve and chromed swivel tap on top to refill with hot and cold water
- * Uniformly heated in the base and side walls of the pan by integrally generated saturated steam at a temperature of 110°C and a pressure of 0,4 bar in the jacket
- * Hot, cold or mixed water supply for filling the pan through control knob
- * Relief valve to evacuate excess air in the jacket during heating phase
- * Incoloy armored heating elements fitted inside the jacket cavity base with safety thermostat on electric models
- * Double skin flue with removable cast iron grid

OPTIONS

- * Autoclave lid

ACCESSORIES

- *
- *
- *
- *

STANDARDS & CERTIFICATES

- * EN 60335-1 European Standard relating to safety of household and similar electrical appliances
- * EN 60335-2-47 European Standard relating to safety of household and similar electrical appliances







**ÖZTİRYAKİLER**

Cumhuriyet Mah.Hadımköy Yolu Cad.No:8

Büyükcçekmece-İstanbul-TURKEY

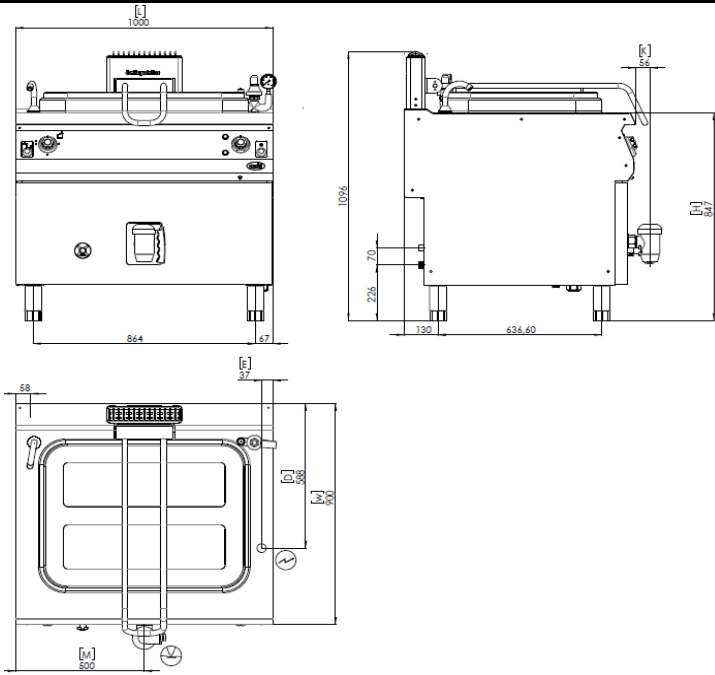
e-mail: export@oztiryakiler.com.tr

web: www.oztiryakiler.com.tr

code: 7855.N1.10908.07	900 SERIE ELECTRICAL RECTANGULAR BOILING PAN 250 lt INDIRECT HEAT	model: OTEI 250							
									
DIMENSIONS (Net)		DIMENSIONS (Shipping)							
* Width (mm)	1000	* Width (mm)							
* Depth (mm)	900	* Depth (mm)							
* Height (mm)	850	* Height (mm)							
* Weight (kg)	130	* Weight (kg)							
*		* Volume (m³)							
COMPOSITION OF TOP									
* Capacity	250	liter							
* Vessel rectangular width	784 mm								
* Vessel rectangular height	610 mm								
* Vessel rectangular depth	589 mm								
COMPOSITION OF THE BOTTOM PART									
*									
*									
*									
*									
	GAS								
* Power:	kW	Btu/hr	kcal	Gas Inlet:					
* G20	Pressure:		m³/h						
* G30/G31	Pressure:	mbar	kg/h						
* G30	Pressure:								
	ELECTRICITY								
* Power:	27	kW							
* Supply Voltage:	400V / 3 NPE 50/60 Hz	230V / 3 PE 50/60 Hz							
* Protection Class:	IP	21							
	WATER-IN								
* Cold Water Inlet:	3/4"	Pressure (min-max)	1,5-6	bar	150-600	kPa	Temperature (min-max)	5-60	°C
* Hot Water Inlet:	3/4"								
* Hardness:	0-10	F							
	DRAIN								
* Drain tap on front panel with safety plastic handle								2"	
*									