





# CK8305 Twin Tank 12 Ltr Electric Fryer- Specification



-  Precise thermostatic control.
-  Heavy duty heating element.
-  5kW, 230V/50Hz  
2 x plugs supplied.
-  Removable element & controller for quick servicing.

<b>External Dimensions</b>	W550 x D410 x H310mm
<b>Fry Tank Dimensions</b>	W260 x D320 x H130mm
<b>Fryer Basket Dimensions</b>	W140 x D200 x H120mm
<b>Capacity</b>	6 Litres (per tank)
<b>Temperature Range</b>	+50 / +190 °C
<b>Interior/ Exterior</b>	Stainless Steel

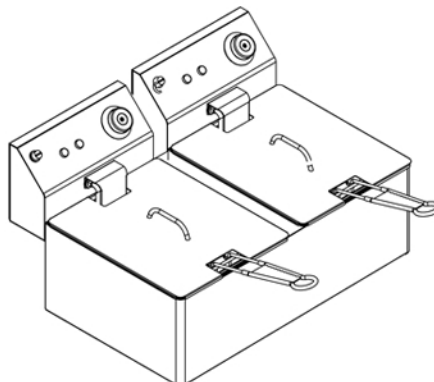
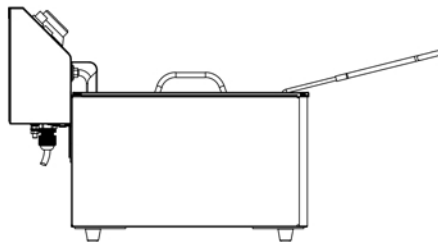
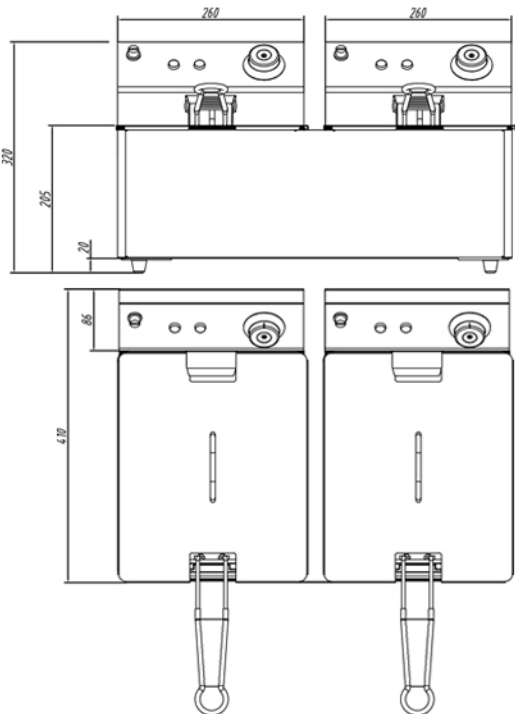

## Caterkwik Ltd

The Lakeland Catering Centre  
Newlands  
Ulverston  
Cumbria  
LA12 7QQ

01229 480001

[info@caterkwik.co.uk](mailto:info@caterkwik.co.uk)