



CK8312 Single Tank 6 Ltr Fryer with Tap- Specification



-  Precise thermostatic control.
-  Heavy duty heating element.
-  3kW, 220V/50Hz supply. requires hardwiring.
-  Removable element & controller for quick servicing.

External Dimensions	W290 x D440 x H410mm
Fry Tank Dimensions	W240 x D300 x H195mm
Fryer Basket Dimensions	W182 x D220 x H140mm
Capacity	6 Litres
Temperature Range	+50 / +190 °C
Interior/ Exterior	Stainless Steel

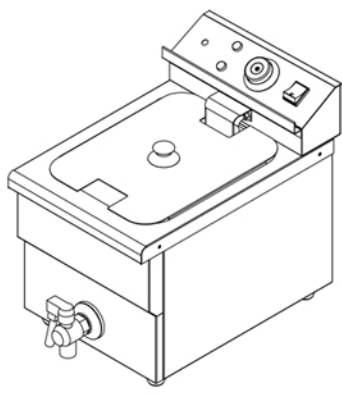
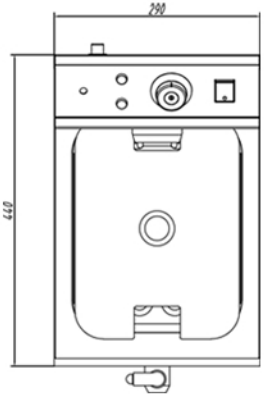
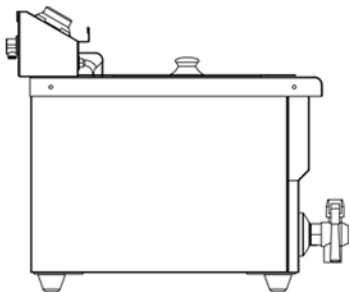
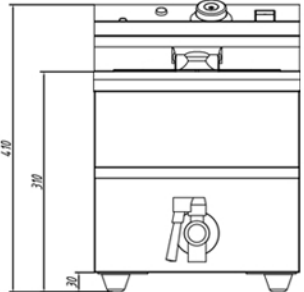

Caterkwik Ltd

The Lakeland Catering Centre
 Newlands
 Ulverston
 Cumbria
 LA12 7QQ

01229 480001
info@caterkwik.co.uk

