

robot coupe®

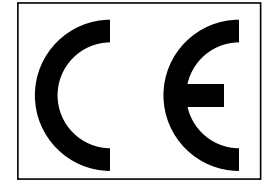

CL 52 E



DECLARATION OF CONFORMITY

Robot-Coupe SNC:

Declares that the machines identified by their type above, comply with:

- The essential requirements of the following European directives and with the corresponding national regulations:
 - Directive «Machinery» 2006/42/EC,
 - Directive «Low voltage» 2006/95/EC,
 - Directive «Electromagnetic compatibility» 2004/108/EC,
 - Regulation (EC) n°1935/2004 «Materials and articles intended to come into contact with food»,
 - Regulation (EU) n°10/2011 «Plastic materials and articles intended to come into contact with food»,
 - Directive «Reduction of Hazardous Substances (RoHS) 2002/95/EC,
 - Directive «WEEE» 2002/96/EC,
- The requirements of the European harmonized standards and with the standards specifying the hygiene and safety requirements:
 - EN 12100 -1 & 2 - 2004: Safety of machinery – General principles for design,
 - EN 60204-1 -2006: Safety of machinery – Electrical equipment of machines,
 - EN 12852: Food Processors and Blenders,
 - EN 1678-1998: Vegetable Cutting Machines,
 - EN 454: Blender-Mixers,
 - EN 12853: Hand-held Blenders and Whisks (stick blenders),
 - EN 14655: Bread Slicers,
 - EN 13208: Vegetable Preparation Machines,
 - EN 13621: Salad Spinners,
 - EN 60529-2000: Degrees of protection,
 - IP 55 for the electrical controls,
 - IP 34 for the machines.

Signed in Montceau en Bourgogne on 19 February 2013

Alain NODET
Industrial Director

SUMMARY

■ WARRANTY

■ IMPORTANT WARNING

■ INTRODUCTION TO YOUR NEW VEGETABLE PREPARATION MACHINE CL 52 "E" Version

■ SWITCHING ON THE MACHINE

- Advice on electrical

■ THE LEVER-OPERATED HOPPER AND ITS TOOLS

■ HOPPER USE AND DISC CHOICE

■ CLEANING

■ MAINTENANCE

- Motor seal
- Blades and plates
- Grating discs

■ TECHNICAL SPECIFICATIONS

- Weight
- Dimensions
- Working height
- Noise level
- Electrical data

■ SAFETY

■ STANDARDS

■ TECHNICAL DATA

- Exploded views
- Electric and wiring diagrams

ROBOT-COUCPE S.N.C., LIMITED WARRANTY

Your new ROBOT-COUCPE appliance is warranted to the original buyer for a period of one year from the date of sale if you bought it from ROBOT-COUCPE S.N.C.

If you bought your ROBOT-COUCPE product from a distributor your product is covered by your distributor's warranty (Please check with your distributor terms and conditions of the warranty).

The ROBOT-COUCPE S.N.C. limited warranty is against defects in material and/or workmanship.

THE FOLLOWING ARE NOT COVERED BY THE ROBOT-COUCPE S.N.C. WARRANTY:

1 - Damage caused by abuse, misuse, dropping, or other similar damage caused by or resulting from failure to follow assembly, operating, cleaning, user maintenance or storage instructions.

2 - Labour to sharpen and/ or replacements for blades which have become blunt, chipped or worn after a normal or excessive period of use.

3 - Materials or labour to replace or repair scratched, stained, chipped, pitted, dented or discoloured surfaces, blades, knives, attachments or accessories.

4 - Any alteration, addition or repair that has not been carried out by the company or an approved service agency.

5 - Transportation of the appliance to or from an approved service agency.

6 - Labour charges to install or test new attachments or accessories (i.e., bowls, discs, blades, attachments) which have been arbitrarily replaced.

7 - The cost of changing direction-of-rotation of three-phase electric motors (Installer is responsible).

8 - SHIPPING DAMAGES. Visible and latent defects are the responsibility of the freight carrier. The consignee must inform the carrier and consignee immediately, or upon discovery in the case of latent defects.

KEEP ALL ORIGINAL CONTAINERS AND PACKING MATERIALS FOR CARRIER INSPECTION.

Neither ROBOT-COUCPE S.N.C. nor its affiliated companies or any of its distributors, directors, agents, employees, or insurers will be liable for indirect damage, losses, or expenses linked to the appliance or the inability to use it.

The ROBOT-COUCPE S.N.C. warranty is given expressly and in lieu of all other warranties, expressed or implied, for merchantability and for fitness toward a particular purpose and constitutes the only warranty made by ROBOT-COUCPE S.N.C. France.

IMPORTANT WARNING



WARNING : In order to limit accidents such as electric shocks or personal injury, and in order to limit material damage due to misuse of the appliance, please read these instructions carefully and follow them strictly. Reading the operating instructions will help you get to know your appliance and enable you to use the equipment correctly. Please read these instructions in their entirety and make sure that anyone else who may use the appliance also reads them beforehand.

UNPACKING

- Carefully remove the equipment from the packaging and take out all the boxes or packets containing attachments or specific items.
- **WARNING** - some of the tools are very sharp e.g. blades, discs... etc.

INSTALLATION

- We recommend you install your machine on a perfectly stable solid base.

CONNECTION

- Always check that your mains supply corresponds to that indicated on the identification plate on the motor unit and that it can withstand the amperage.
- The machine must be earthed.

HANDLING

- Always take care when handling the blades, as they are extremely sharp.

ASSEMBLY PROCEDURES

- Follow the various assembly procedures carefully (see page 19) and make sure that all the attachments are correctly positioned.

USE

- Never try to override the locking and safety systems.
- Never insert an object into the container where the food is being processed.
- Never push the ingredients down with your hand.
- Do not overload the appliance.
- Never switch the appliance on when it is empty.

CLEANING

- As a precaution, always unplug your appliance before cleaning it.
- Always clean the appliance and its attachments at the end of each cycle.
- Never immerse the motor unit in water.
- For parts made from aluminum, use cleaning fluids intended for aluminum.

- For plastic parts , do not use detergents that are too alkaline (e.g., containing too much caustic soda or ammonia).
- Robot-Coupe can in no way be held responsible for the user's failure to follow the basic rules of cleaning and hygiene.

MAINTENANCE

- Before opening the motor housing, it is absolutely vital to unplug the appliance.
- Check the seals and washers regularly and ensure that the safety devices are in good working order.
- It is particularly important to maintain and check the attachments since certain ingredients contain corrosive agents, e.g. citric acid.
- Never operate the appliance if the power cord or plug has been damaged or if the appliance fails to work properly or has been damaged in any way.
- Do not hesitate to contact your local Maintenance Service if something appears to be wrong.

INTRODUCTION TO YOUR NEW VEGETABLE PREPARATION MACHINE CL 52 "E" Version

The CL 52 is perfectly geared to professional needs. It can perform any number of tasks, which you will gradually discover as you use it.

The CL 52 is equipped with a removable lid, metal bowl and stainless steel motor base. The full moon hopper is ideal for cutting large products.

The CL 52 is supplied with a wide range of discs and grids to satisfy even the most demanding chefs when it comes to cutting up fruit and vegetables, i.e. slicing, grating, julienne, dicing and french fried potatoes discs. The head has been specially designed to handle bulky vegetables.

Thanks to its simple design, all components requiring frequent handling for maintenance or cleaning can be fitted and removed in a trice.

To make things easier for you, this manual gives a breakdown of all the various fitting operations.

This manual contains important information designed to help the user get the most out of this vegetable preparation machine.

We therefore recommend that you read it carefully before using your machine.

We have also included a few examples to help you get the feel of your new machine and appreciate its numerous advantages.

SWITCHING ON THE MACHINE

Before plugging in, check that your power supply corresponds to that indicated on the machine's identification plate.

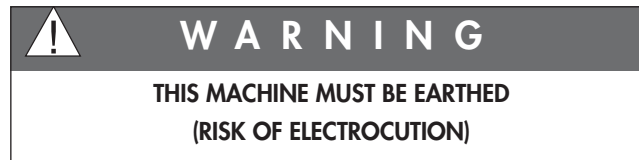

• CL 52 E Single-Phase

ROBOT-COUPE CL 52 are fitted with various types of motors:

230 V / 50 Hz / 1
120 V / 60 Hz / 1
220 V / 60 Hz / 1

The machine comes with a single-phase plug connected to a power cord.

• CL 52 E Three-Phase

ROBOT-COUPE CL 52 are fitted with various types of motors:

400 V / 50 Hz / 3
220 V / 60 Hz / 3
380 V / 60 Hz / 3

The machine is supplied with a cable to which you simply attach the appropriate electrical plug for your system. The cable has four wires, one earth wire, plus three phase wires.

If you have a 4-pin plug:

- 1) Connect the green and yellow earth wire to the earth pin.
- 2) Connect the three other wires to the remaining pins.

If you have more than 4 pins in the plug please note the ROBOT-COUPE does not require a neutral wire.

Switch on the empty machine, making sure that the blade is rotating properly in an anti-clockwise direction.

On the motor base, a red arrow marks the blade rotation direction. If the blade turns in a clockwise direction, swap over two wires:

Since GREEN/YELLOW is the earth, DO NOT DISCONNECT.

Swap either:

- the ❶ and the ❷
- the ❶ and the ❸
- the ❷ and the ❸

THE LEVER-OPERATED HOPPER AND ITS TOOLS

This hopper allows you to prepare all types of vegetables:

- the large feed hopper is used to prepare bulky vegetables such as cabbage, celery, lettuce, etc.,
- the tube is used to prepare long or fragile fruit or vegetables.

Two types of tool are designed for the lever-type hopper:

1) the loading cone

Always remember to fit an ejection tool if the removable divider is not being used.

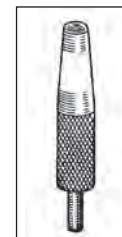

2) The **hollowing cutter** used only to prepare cabbage. This tool can be used to shred or grate a whole cabbage without having to cut it beforehand.



A **special tool** has also been designed to **remove** the hollowing cutter.

1 Assembly

With the motor unit facing you, slot the black or white ejection tool onto the drive shaft and check that it is correctly positioned at the bottom of the bowl.



Two ejection tools:

The CL 52 is supplied with two ejection tools. The white ejector has been specially designed to cope with cabbage. For all other vegetables, use the black ejector disc.



Cabbage ejector



Ejector disc

2 Position your chosen disc:



b) You have chosen a dicing unit:

i.e. a grid and a special slicing disc for diced vegetables.

Slicing discs and dicing grids can be mounted in the following combinations:

Dicing grid \ Slicer	5x5 mm	8x8 mm	10x10 mm	14x14 mm	20x20 mm	25x25 mm
5 mm	•					
8 mm		•				
10 mm			•			
14 mm				•		
20 mm					•	
25 mm						•

You will find all the combinations marked • on our machines and accessories price list.

The dimensions of the dicing grid should always be equal to or greater than those of the slicing disc.

Place the dicing grid in the bowl of the vegetable processor.

Make sure that the spur on the grid is fully engaged in the locking slot of the motor unit.

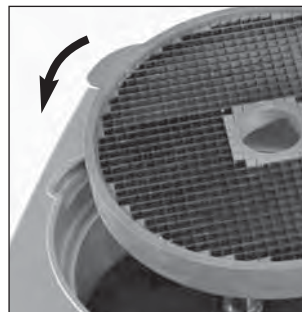

a) If you have opted for a slicing, grating or julienne disc:

position the disc on the motor shaft. To ensure that it is correctly positioned, turn it in a clockwise direction.



Next, fit the corresponding slicing disc (straight-edged blade) and rotate in a clockwise direction to ensure that it is correctly positioned.

c) If you want to use the French fries potatoes cutting equipment:

This equipment comprises a French fries grid and a special French fries slicing disc.

! WARNING

To get the very best results when cutting french fries, remember to insert **the removable divider** in the hopper and load the potatoes into the left-hand compartment (see photo opposite).

Position the French fries grid in the vegetable preparation bowl.

Check that it is correctly positioned with the French fries plate positioned at the outlet.



No tools (loading cone or cabbage corer) are required when using the divider.



Next fit the appropriate slicing disc and rotate in a clockwise direction to check that it is correctly positioned.

3 Then, screw the loading cone or the hollowing cutter onto the motor shaft according to the type of vegetable to be prepared (unless using the removable divider).

It should be remembered that the loading cone is suitable for all types of vegetable except for cabbage. The hollowing cutter is designed for that purpose.



Loading cone



Cabbage corer



Please use the spanner supplied with the appliance to remove the cabbage corer.

No tools (loading cone or cabbage corer) are required when using the divider.

4 Slip the hinge pin into the locations provided at the back of the motor base.

The locking handle should now be facing you, on the right.



5 Slide the hinge pin into the slots provided at the back of the motor base.

Next, lock the lid onto the motor unit using the locking handle.

TO CHANGE THE DISC:

1) With the motor unit facing you, release the aluminium locking handle used to lock the veg prep head onto the motor unit with your right hand.



Lift the vegetable preparation head, tilting it back to release the bowl.

2) Remove the disc by lifting it from underneath using the hub and if necessary, turn in an anti-clockwise direction to release...

If you have been using a dicing unit, we recommend you remove the grid and the disc at the same time. This will be easier if you first rotate the emptying disc and pull it out by the two holes.

3) When fitting dicing equipment, we recommend that you clean the inside of the bowl with a sponge, particularly the part onto which the grid is to be fitted.

Always use a properly cleaned grid.

Never process soft foodstuffs after hard ones without properly cleaning the grid beforehand.

Use our **D-Clean Kit** (ref. 39881) to clean your 5x5, 8x8 and 10x10 dicing grids quickly and easily

4) Fit the discharge plate, disc or dicing equipment as indicated in "assembly procedures" in points 1 and 2.

5) Close the veg prep lid and lock it onto the motor unit with the locking handle.



HOPPER USE AND DISC CHOICE

The lid of the vegetable processor features two feed openings:

- **One large hopper** for cutting vegetables such as cabbage, celeriac, etc... This hopper can be partitioned with a divider. This makes it easier to deal with round or oval vegetables.
- **One cylindrical hopper** for long vegetables and high-precision cutting. Cutting quality can be optimized if the compartment is used as a cutting guide.
- Raise the pusher to gain access to the feed opening.

HOW TO USE THE LARGE HOPPER



WARNING



To get the very best results when cutting french fries, remember to insert **the removable divider** in the hopper and load the potatoes into the left-hand compartment (see photo opposite).

Depending on the application, use the removable divider to stack the vegetables higher in the hopper (e.g. carrots and potatoes) and prevent the more fragile ones (e.g. tomatoes) from being damaged by the loading cone.

- Fill the feeder right up to the top with vegetables.
- Lower the pusher so that it is flush with the top of the feed opening.
- Press the pusher down to guide the food through the machine. The exact amount of pressure required will depend on the nature of the cut, bearing in mind that too much force reduces cutting quality without increasing throughput.
- Cut cabbages in half and remove the core before processing, in order to avoid unnecessary strain and ensure an end-product of a higher quality.

HOW TO USE THE CYLINDRICAL HOPPER

Fill the feeder right up to the top with vegetables. Apply a downwards pressure on the pusher and maintain it until all the vegetables have been processed.

Always press the vegetables down with a pusher to improve cutting efficiency.

SLICERS



S 0,8	cabbage
S 1	carrot / cabbage / cucumber / onion / potato / leek
S 2 / S 3	lemon / carrot / mushroom / cabbage / potato / cucumber / zucchini / onion / leek / bell pepper
S 4 / S 5	eggplant / beet root / carrot / mushroom / cucumber / bell pepper / radish / lettuce / potato / leek / tomato
S 8 / S 10	eggplant / potato / zucchini / carrot
S 14	potato / zucchini / carrot

RIPPLE CUT SLICERS



R 2	beet root / potato / carrot / zucchini
R 3	beet root / potato / carrot / zucchini
R 5	beet root / potato / carrot / zucchini

GRATERS



G 1,5	céleriac / cheese	G 7	cabbage / cheese
G 2	carrot / céleriac / cheese	G 9	cabbage / cheese
G 3	carrot		Parmesan / chocolate
G 5	cabbage / cheese		Radish

JULIENNE



J 2x2	carrot / céleriac / potato
J 2x4	carrot / beet root / zucchini / potato
J 2x6	carrot / beet root / zucchini / potato
J 4x4	eggplant / beet root / zucchini / potato
J 6x6	eggplant / beet root / céleriac / zucchini / potato
J 8x8	céleriac / potato

DICE



D 5x5	carrot / zucchini / cucumber / céleriac
D 8x8	potato / carrot / zucchini / beet root
D 10x10	potato / carrot / zucchini / beet root / turnip / oignon / apple (fruit)
D 14x14	potato / carrot / zucchini / beet root / céleri
D 20x20	potato / carrot / zucchini / pineapple / turnip
D 25x25	potato / courgette / turnip / apple (fruit) / melon / watermelon

FRENCH FRIES



F 8x8	potato
F 10x10	potato

CLEANING



WARNING

As a precaution, always unplug your appliance before cleaning it (risk of electrocution).

After removing the head of the vegetable preparation machine, take off the disc, followed by the grid and discharge plate where necessary.

Dishwashers are best avoided in order to prevent the aluminium from becoming tarnished.

Instead we recommend that you clean the machine by hand using washing-up liquid.

If you do put your machine in a dishwasher, we suggest that you use a detergent designed specially for aluminium.

Never immerse the motor base in water.

Clean it with a sponge.



IMPORTANT

Check that the detergent you use is suitable for cleaning aluminium parts. Some washing agents are highly alkaline (e.g. high caustic soda or ammonia content) and therefore totally incompatible with aluminium, causing the parts to blacken.

MAINTENANCE

• MOTOR SEAL

The motor seal on the shaft should be lubricated regularly using a food safe lubricant.

In order to keep the motor completely watertight, it is advisable to check the motor seal regularly for wear and tear and replace if necessary.

The motor seal can be easily replaced without having to remove the motor, so we strongly advise you to ensure that is in good condition.

• BLADES AND PLATES

The blades on all our discs are wearing parts that need to be replaced from time to time, in order to maintain consistently high cutting quality.

• GRATING DISCS

Grating discs deteriorate over time. We recommend you replace them from time to time, in order to maintain consistently high cutting quality.

TECHNICAL SPECIFICATIONS

• WEIGHT

	Net	Gross
CL 52 E complete	25.5 kg	28 kg
Average weight of one disc	0,5 kg	0,6 kg

• DIMENSIONS (in mm)

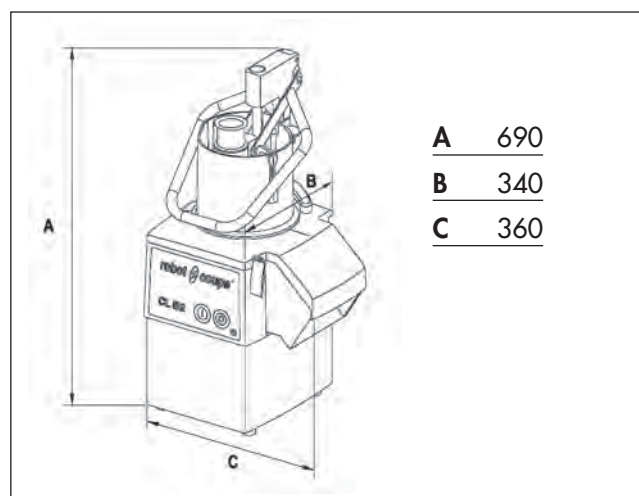

• WORKING HEIGHT

We recommend that you position the CL 52 on a stable worktop so that the upper edge of the large feed hopper is at a height of between 1.20 and 1.30 m.

• NOISE LEVEL

The equivalent continuous sound level when the CL 52 is operating on no-load is less than 70 dB(A).

• ELECTRICAL DATA

Single-phase machine

Motor	Speed (rpm)	Intensity (Amp)
230 V/50Hz	375	5.3
240 V/50Hz	375	5.3
120 V/60Hz	450	8.9
220 V/60Hz	450	5.3

Three-phase machine

Motor	Speed (rpm)	Intensity (Amp)
400 V/50Hz	375	2.0
220 V/60Hz	450	4.4
380 V/60Hz	450	2.6

- Power shown on data plate.

SAFETY



WARNING

The discs are very sharp, handle with care.

The CL 52 is equipped with a magnetic safety system which stops the motor as soon as either the wide feeder or the lid is opened.

This makes it impossible to gain access to the slicing tool while it is still in motion.

As soon as the lid opens, the motor stops.

To restart your machine, simply relock the lid.

In addition, the cover locking catch is equipped with a safety mechanism which prevents the processor from being used if the cover is not correctly positioned.

The CL 52 is equipped with a **thermal protection system** which automatically stops the motor if it has been running for too long or is overloaded.

If this happens, allow the machine to cool completely before restarting.



RE M I N D E R

Do not open the lid until the motor has come to a complete stop.

Never tamper with the locking and safety systems.

Never put a hand object in the bowl while the machine is operating.

Never force the ingredients down with your hands.

STANDARDS

Consult the declaration of compliance on page 2.

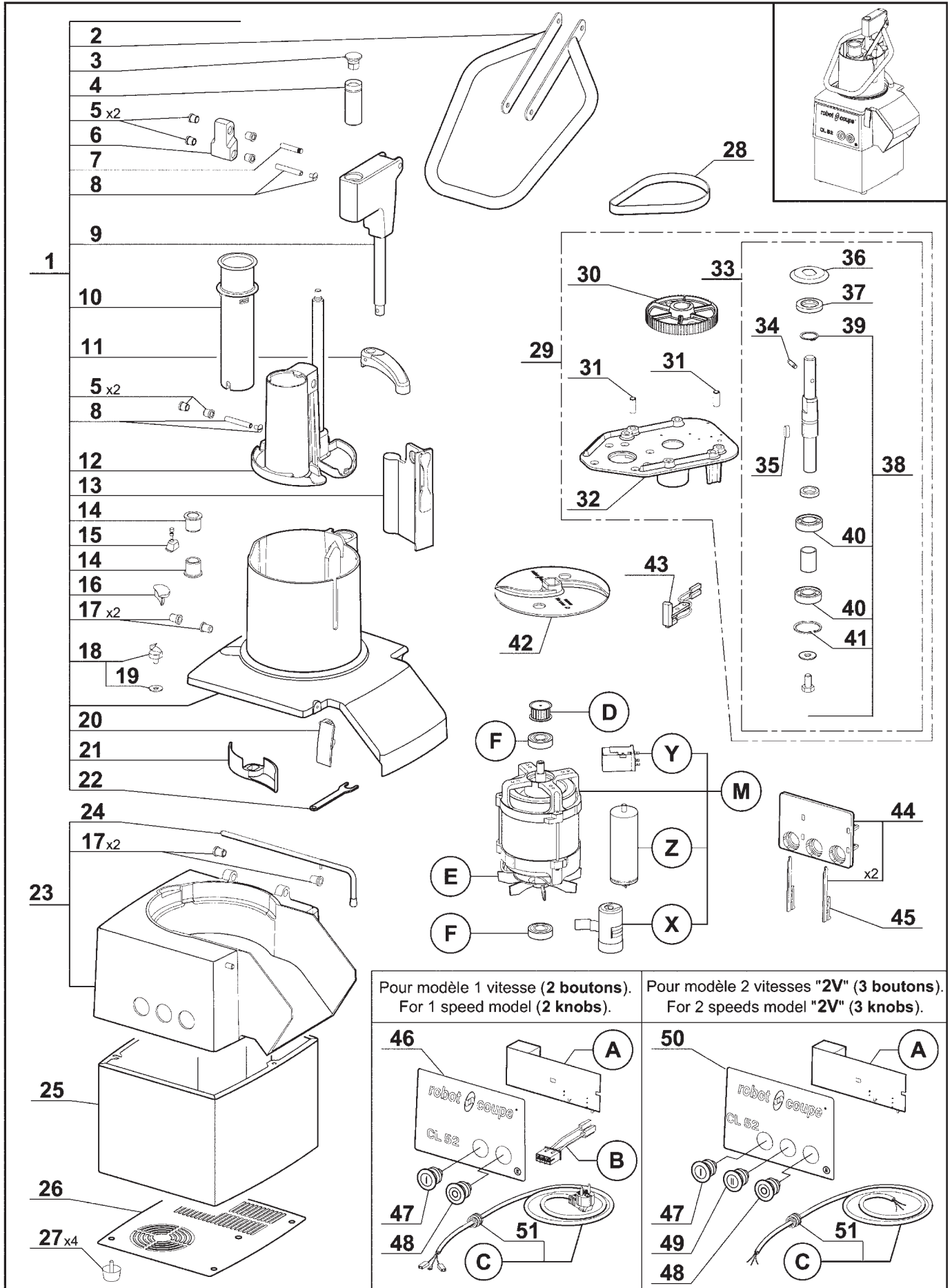

Index	Pièce / Part	Désignation	Description
1	39 673	COUVERCLE COMPLET	COMPLETE FEED LEAD
2	39 661	POIGNEE CL52E	HANDLE CL52E
3	39 663	BUTEE DE POUSSOIR CL52E	PUSHER ABUTMENT CL52E
4	39 672	BAGUE DE GLISSEMENT CL52E	RING OF SLIDING CL52E
5	39 664	BAGUE EPAULEE (Qté=2)	SHOULDERED RINGS (Qty=2)
6	39 665	BIELLETTE ARRIERE	BACK TIEROD
7	39 666	AXE PIVOT 8x40 MOL CL52E	AXLE 8x40 CL52E
8	39 667	AXE PIVOT 8x50 CL50E	AXLE 8x50 CL52E
9	39 668	GUIDE POUSSOIR MONTE CL52E	PUSHER GUIDE ASSEMBLY CL52E
10	39 662	POUSSOIR CAROTTE CL52E	CARROTS PUSHER CL52E
11	39 671	PORTE AIMANT MONTE CL52E	MAGNET HOLDER ASSEMBLY CL52E
12	39 669	POUSSOIR LEGUME MONTEE CL52E	VEGETABLE PUSHER ASSEMBLY CL52E
13	39 660	CLOISON AMOVIBLE CL52E	REMOVABLE WALL
14	39 670	PALIER EPAUL 15x25 CL52E (Qté=2)	SHOULDERED RINGS 18x25 (Qty=2)
15	29 706	ENSEMBLE BUTEE POUSSOIR	PUESHER STOP ASSEMBLY
16	117 321	BUTEE ANTI FRICTION	ANTI-FRICTION STOP
17	39 705	BAGUE EPAULEE (Qté=2)	SHOULDERED RINGS (Qty=2)
18	29 692	ENSEMBLE EVIDOIR	GOUGE ASSEMBLY
19	117 200	RONDELLE ANTI FRICTION	ANTI-FRICTION WASHER
20	29 501	ENSEMBLE TAQUET D'ACCROCHAGE	LATCH ASSEMBLY
21	118 420	EVACUATEUR CHOUX	CABBAGE DISCHARGE DEVICE
22	118 436	CLEF EVIDOIRE	GOUGE WRENCH
23	39 706	ENSEMBLE CUVE	BOWL ASSEMBLY
24	100 703	TIGE DE CHARNIERE	HINGE PIN
25	118 430	CAPOT INOX	STAINLESS STEEL MOTOR ENCLOSURE
26	117 687	PLAQUE DE FOND	BOTTOM PLATE
27	500 247	PIED (Qté=4)	FOOT (Qty=4)
28	507 341	COURROIE HTD 450-5Mx15	BELT HTD 450-5Mx15
29	39 707	ENSEMBLE SUPPORT TRANSMISSION	MOTOR SUPPORT ASSEMBLY
30	105 529	POULIE RECEPTRICE	DRIVEN PULLEY
31	510 218	DOUILLE ELASTIQUE	LOCKING PIN
32	105 531	SUPPORT TRANSMISSION	MOTOR SUPPORT
33	39 708	ENSEMBLE AXE RECEPTEUR	TRANSMISSION SHAFT ASSEMBLY
34	110 308	GOUPILLE ENTRAINEMENT	DRIVING PIN
35	203 015	CLAVETTE 6X6X20	KEY 6X6X20
36	101 547	DEFLECTEUR	DEFLECTOR
37	501 678	BAGUE ETANCH 25x42x7	SHAFT SEAL 25X42X7
38	39 709	ENSEMBLE ROULEMENTS	BALL BEARINGS ASSEMBLY
39	203 068	CIRCLIPS EXT 25	C-RING (25)
40	510 217	ROULEMENT 6004 2RS	BALL BEARING 6004 2RS
41	203 206	CIRCLIPS INT 42	C-RING (42)
42	102 690	DISQUE EVACUATEUR	SLING PLATE
43	29 451	ENSEMBLE INTERRUPTEUR DE SECURITE	SAFETY SWITCH ASSEMBLY
44	29 533	ENSEMBLE SUPPORT PLATINE	CONTROL BOARD SUPPORT ASSEMBLY
45	117 703	CLAVETTE FIXATION PLATINE	CONTROL BOARD FIXING KEY
46	403 995	PLAQUE FRONTALE CL52E DEUX BOUTONS	FRONT PLATE (2 KNOBS) CL52E
47	502 170	BOUTON VERT I	GREEN KNOB I
48	502 169	BOUTON ROUGE	RED KNOB
49	503 268	BOUTON VERT II	GREEN KNOB II
50	403 998	PLAQUE FRONTALE CL52E 3 BOUTONS	FRONT PLATE (3 KNOBS) CL52E
51	515 515	PRESSE ETOUPE	POWER CORD STRAIN RELIEF

Index	Désignation	Description
A	CARTE DE COMMANDE	CONTROL BOARD
B	FAISCEAU DE CONNEXION MOTEUR	MOTOR WIRING HARNESS
C	CABLE D'ALIMENTATION	POWER CORD
D	ENSEMBLE POULIE MOTRICE	DRIVING PULLEY ASSEMBLY
E	VENTILATEUR	FAN
F	ROULEMENT	BALL BEARING
M	MOTEUR	MOTOR
X	CONDENSATEUR DE DEMARRAGE	STARTING CAPACITOR
Y	RELAIS	RELAY
Z	CONDENSATEUR PERMANENT	PERMANENT CAPACITOR

Type	Voltage	A	B	C	D	E	F	M	X	Y	Z
T01	230/50/1	102 481	49 039	507 026	29 530	104 925	501 270	303 234	502 474	504 127	502 473
T02	230/50/1 ZAF			39 600							
T03	240/50/1 UK			507 029							
T04	240/50/1 Aust			507 028							
T05	220/60/1			507 026							
T06	220/60/1 BRA			39 602							
T07	120/60/1			507 027							
T08	400/50/3	102 479	29 600	515 570	29 530	106 025	501 270	303 080	X	Y	Z
T09	220/60/3							303 077			
T10	380/60/3							303 078			
T11	400/50/3 2V	106 250	X	515 570	29 530	106 025	501 270	303 250	X	Y	Z

Exemple de recherche : Vous avez acheté un **CL52 E** dont la référence est : **2 180**.

Pour trouver les références des pièces identifiées sur le dessin par une lettre, chercher la référence de votre appareil dans le tableau ci-dessous et identifier son "**Type**" (ici T01), puis dans le tableau précédent, lire les références des pièces sur la ligne correspondante à ce "**Type**".

Research example : You have bought a **CL52 E** whose reference is : **2 180**.

To find the part numbers of the parts identified in the drawing by a letter, look for your machine reference in the table below and identify its "**Type**" (here T01), then in the above table, read the part numbers in the line corresponding to this "**Type**".

Type	Voltage	Machines									
T01	230/50/1	24 490	2 180	2 181	2 182	2 183					
T02	230/50/1 ZAF	24 491									
T03	240/50/1 UK	24 492	2 184								
T04	240/50/1 Aust	24 493									
T05	220/60/1	24 494									
T06	220/60/1 BRA	24 495									
T07	120/60/1	24 496									
T08	400/50/3	24 498	2 185	2 186	2 187	2 188	2 189	2 190			
T09	220/60/3	24 499									
T10	380/60/3	24 500									
T11	400/50/3 2V	24 501									

CL52E - CL55E

120V/60Hz - 220V/60Hz - 230V/50Hz 1~

SCHEMA ELECTRIQUE

ELECTRIC DIAGRAM

ELEKTRISCHES SCHALTBILD

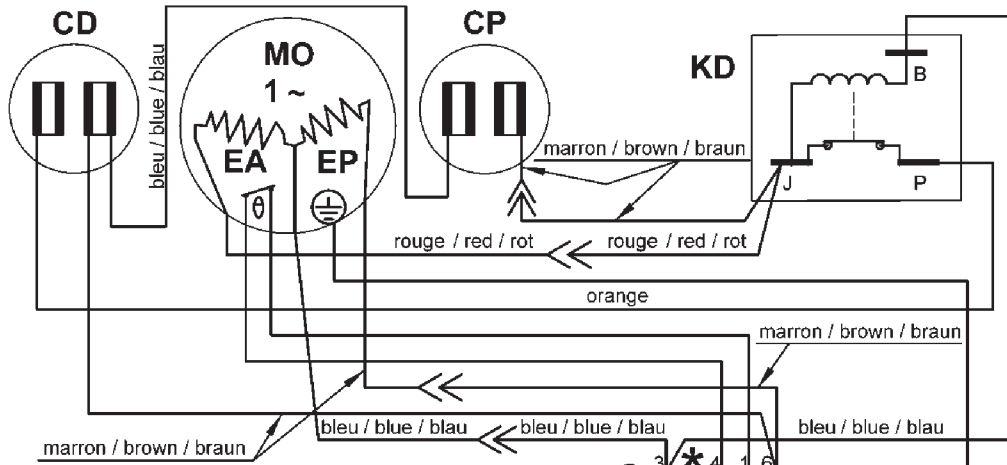

	Français	English	Deutsch
C	Connecteur	Connector	Steckverbindung
CD	Condensateur de Démarrage	Starting capacitor	Anlasskondensator
CP	Condensateur Permanent	Permanent capacitor	Dauerkondensator
EA	Phase Auxiliaire	Starting phase	Hilfsphase
EP	Phase Principale	Main phase	Hauptphase
ISC	Interrupteur Sécurité Couvercle	Lid safety switch	Kontakt Deckelverschluss
ISP1	Interrupteur Sécurité Pousoir	Pusher safety switch	Sicherheitsschalter Stössel
ISP2	Interrupteur de Sécurité Pousoir uniquement CL55E	Pusher safety switch Only CL55E	Sicherheitsschalter Stössel Nur CL55E
KD	Relais de Démarrage	Starting relay	Anlassrelais
MO	Moteur monophasé	Single phase Motor	Motor einphasig
PCB	Carte de Commande Réf 102481	Control Board # 102481	Steuerkarte 102481
SAR	Bouton Pousoir Arrêt	Off switch	Stopschalter
SMA	Bouton Pousoir Marche	On switch	Betriebschalter
⊖	Protecteur thermique moteur	Motor thermal protector	Motorthermoschutz

! Vérifier que le fil d'adaptation à la tension de votre réseau est correctement positionné.
 Check that the wire that allows the adaptation to the supply voltage is on the right terminal.
 Unbedingt prüfen, ob der Draht zur Anpassung an die Spannung Ihres Stromnetzes korrekt positioniert ist.

* Fil non raccordé.
 Wire not connected.
 Nicht angeschlossen.

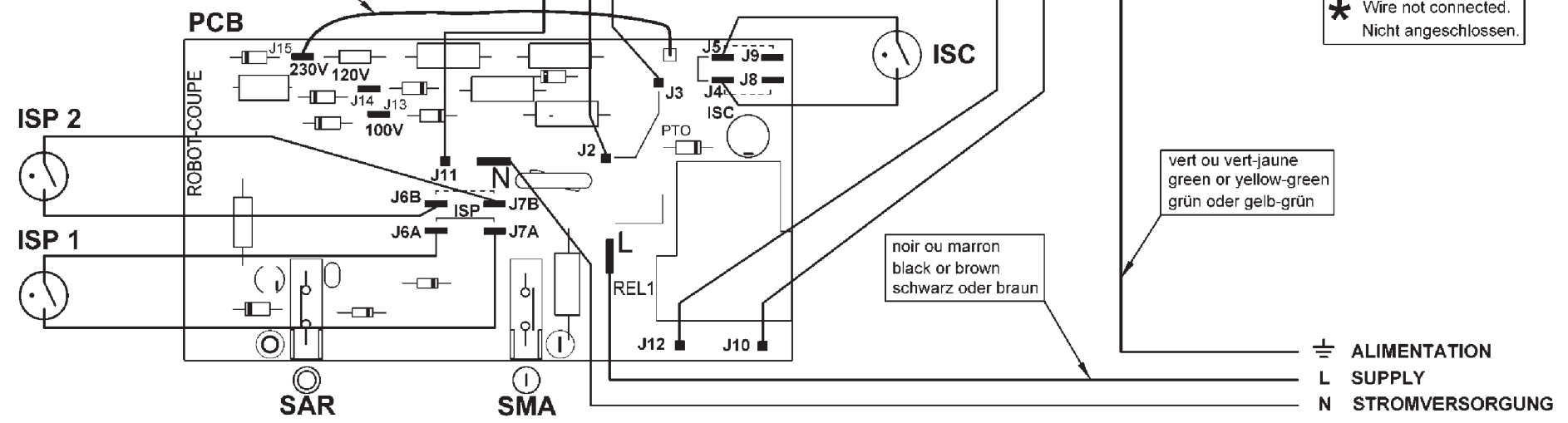

noir ou marron
 black or brown
 schwarz oder braun

vert ou vert-jaune
 green or yellow-green
 grün oder gelb-grün

⊖ ALIMENTATION
 L SUPPLY
 N STROMVERSORGUNG

CL50E 2V - CL50E Ultra 2V - CL52E 2V

400V/50Hz 3~

SCHEMA ELECTRIQUE

ELECTRIC DIAGRAM

ELEKTRISCHES SCHALTBILD

	Français	English	Deutsch
BV1	Bouton Vitesse 1	Low speed switch	Kleine geschwindigkeitshalter
BV2	Bouton Vitesse 2	High speed switch	Grosse geschwindigkeitshalter
C	Connecteur	Connector	Steckverbindung
ISC	Interrupteur Sécurité Couvercle	Lid safety switch	Sicherheitsschalter Deckel
ISP	Interrupteur Sécurité Pousoir	Pusher safety switch	Sicherheitsschalter Stössel
MO	Moteur	Motor	Motor
PCB	Carte de Commande Réf.106250	Control board # 106250	KontrolKarte numer 106250
SAR	Bouton Arrêt	Off switch	Stoppschalter
⊖	Protecteur thermique moteur	Motor thermal protector	Motorthermoschutz

Vérifier que le fil d'adaptation à la tension de votre réseau est correctement positionné .
 Check that the wire that allows the adaptation to the supply voltage is on the right terminal .
 Unbedingt prüfen, ob der Draht zur Anpassung an die Spannung Ihres Stromnetzes korrekt positioniert ist .

 Important
 Précautions
 Wichtiger Hinweis

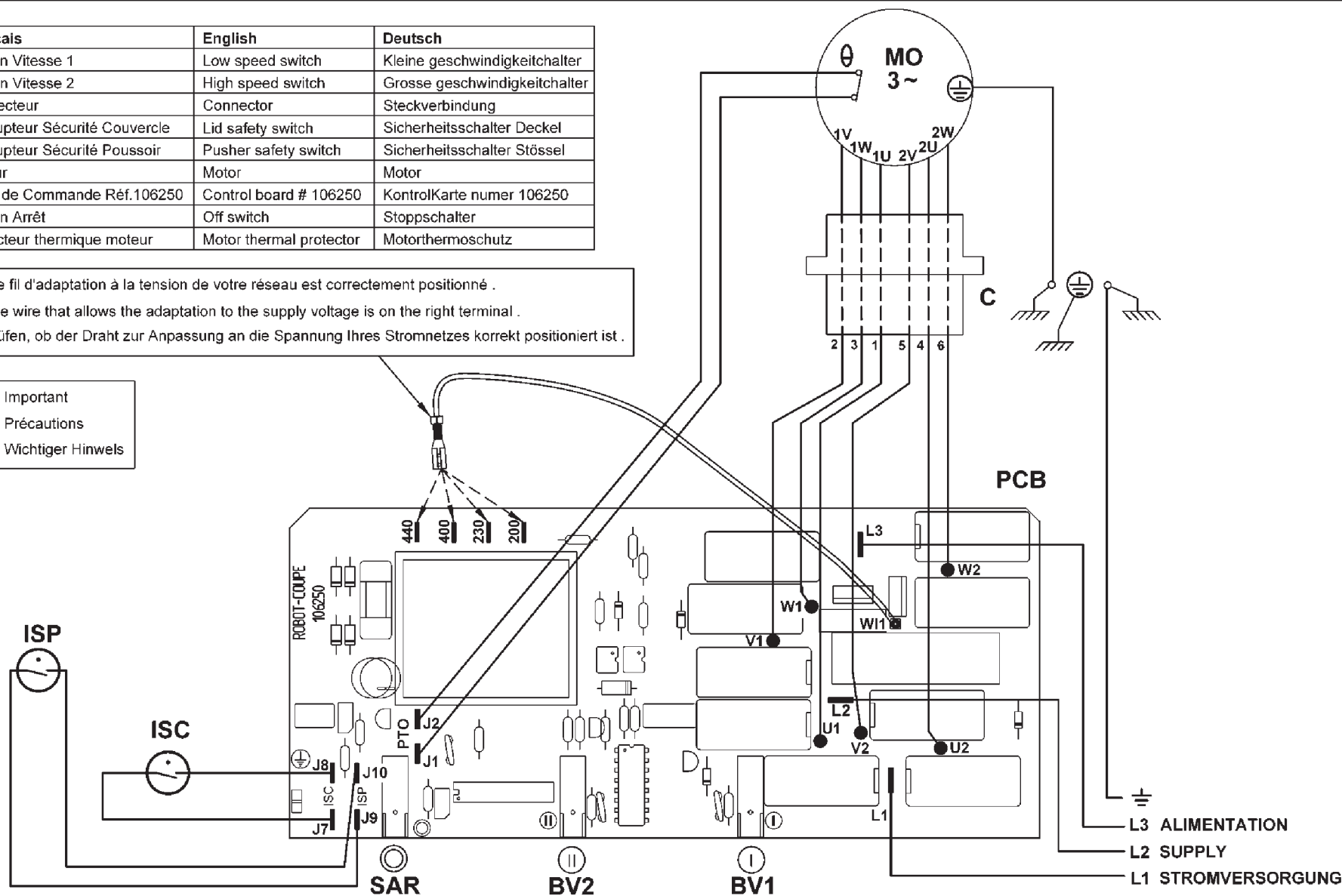

CL50E - CL50E Ultra - CL50 Gourmet A - CL52E

220V/60Hz - 230V/50Hz - 380V/60Hz - 400V/50Hz 3 ~

SCHEMA ELECTRIQUE

ELECTRIC DIAGRAM

ELEKTRISCHES SCHALTBILD

	Français	English	Deutsch
C	Connecteur	Connector	Steckverbindung
ILS1	Interrupteur Sécurité Couverture	Lid safety switch	Kontakt Deckelverschluss
ILS2	Interrupteur Sécurité Pousoir	Pusher safety switch	Sicherheitschalter Stossel
ILS3	Interrupteur de Sécurité Pousoir uniquement CL55D	Pusher safety switch Only CL55D	Sicherheitschalter Stossel Nur BloB CL55D
MO	Moteur monophasé	Single phase Motor	Motor einphasig
PCB	Carte de Commande Réf 102479	Control Board # 102479	komand Kart numer 102479
SAR	Bouton Pousoir Arrêt	Off switch	Stopschalter
SMA	Bouton Pousoir Marche	On switch	Betriebsschalter
θ	Protecteur thermique moteur	Motor thermal protector	Motorthermoschutz

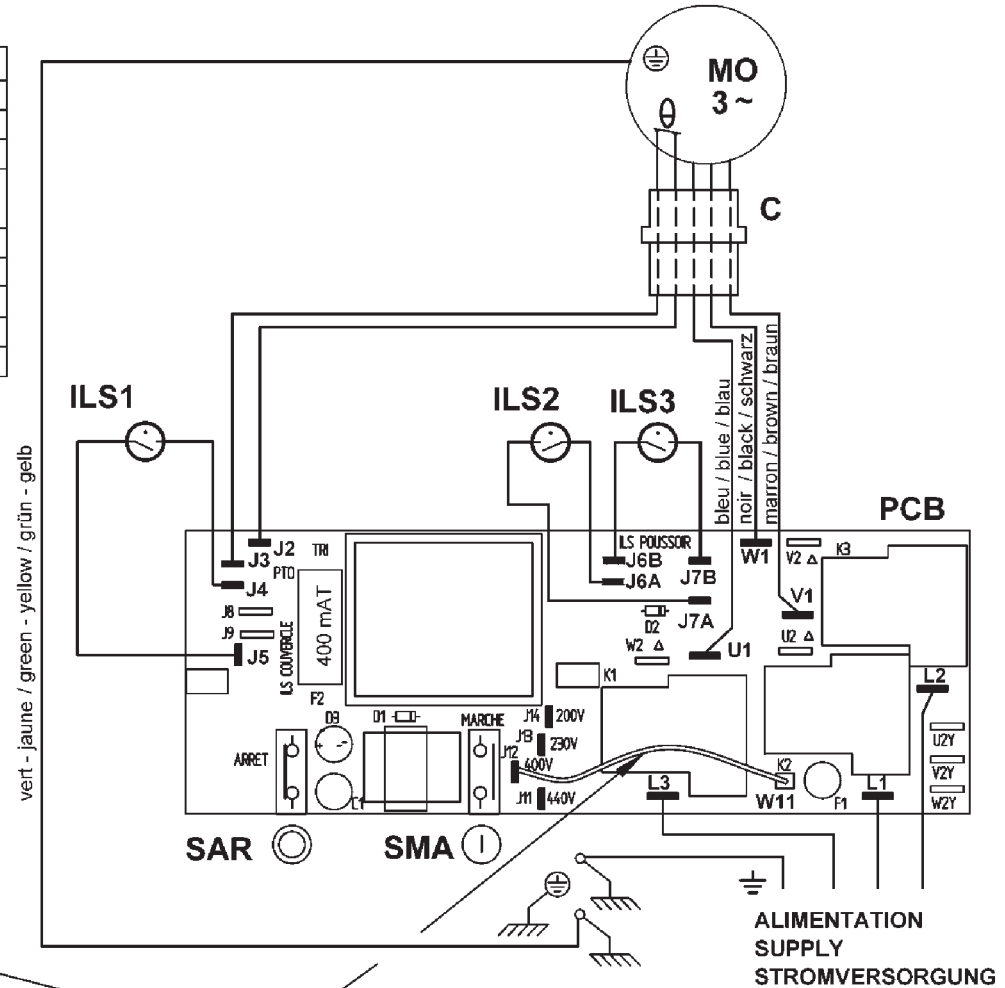
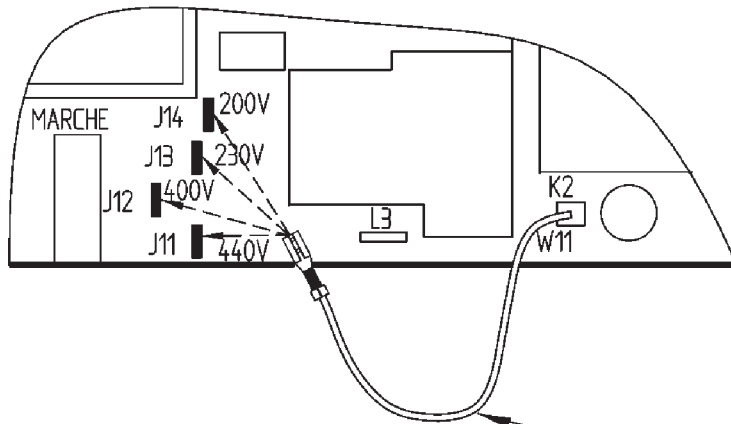

Important
Précautions
Wichtiger Hinweis

Vérifier que le fil d'adaptation à la tension de votre réseau est correctement positionné (voir tableau ci-contre).
Check that the wire that allows the adaptation to the supply voltage is on the right terminal (table in the margin).
Unbedingt prüfen, ob der Draht zur Anpassung an die Spannung Ihres Stromnetzes korrekt positioniert ist (Tafelgegenüber).

Tension d'alimentation Supply voltage Stromspannung	Connexion Terminal Anschluss
200 V	200 (J14)
220 -> 240 V	230 (J13)
380 -> 415 V	400 (J12)
440 V	440 (J11)



robot coupe®

**Head Office, French,
Export and Marketing Department:**
48, rue des Vignerons
94305 Vincennes Cedex- France
Tel.: 01 43 98 88 15 - Fax: 01 43 74 36 26
Email: international@robot-coupe.com

Robot Coupe Australia Pty Ltd:
Unit 3/43 Herbert St
Artarmon NSW 2064 Australia
T (02) 9478 0300
F (02) 9460 7972
Email: orders@robotcoupe.com.au

Robot-Coupe U.K. LTD:
Fleming Way, Isleworth,
Middlesex TW7 6EU
Tel.: 020 8232 1800
Fax: 020 8568 4966
Email: sales@robotcoupe.co.uk

www.robot-coupe.com