



conneX 12



conneX 16

Microwave Combination Oven

Part number: 32Z9010

Approvals:



 **Read instructions before use**

Language: **ENGLISH**

Expanding Your Opportunities

IMPORTANT SAFETY INSTRUCTIONS

All appliances

When using electrical appliances, basic safety precautions should be followed including the following.

WARNING – To reduce the risk of burns, electric shock, fire, injury to persons, or exposure to excessive microwave energy:





- 1) Read all instructions before using the appliance.
- 2) Read and follow the specific 'PRECAUTIONS TO AVOID POSSIBLE EXPOSURE TO EXCESSIVE MICROWAVE ENERGY' on page 3.
- 3) The appliance must be grounded. **Connect only to a dedicated branch and properly grounded outlet.**
- 4) Install or locate this appliance only in accordance with the provided installation instructions.
- 5) Some products such as whole eggs and sealed containers – for example, closed glass jars – can explode and should not be heated in this oven.
- 6) Use this appliance only for its intended use as described in the manual. Do not use corrosive chemicals or vapours in this appliance. This type of oven is specifically designed to heat, cook or toast food. It is not designed for industrial or laboratory use.
- 7) The appliance should not be used by children.
- 8) Do not operate this appliance if it has a damaged door, cord or plug, if it is not working properly, or it has been damaged or dropped.
- 9) This appliance should be serviced only by qualified service personnel. Contact nearest authorised service facility for examination, repair, or adjustment.
- 10) Do not block or cover any openings on the appliance.
- 11) Do not store this appliance outdoors. Do not use this product near water, for example, near a kitchen sink, in a wet basement, near a swimming pool, or similar locations.
- 12) Do not immerse cord or plug in water.
- 13) Keep cord away from heated surfaces.
- 14) Do not let cord hang over edge of table or counter.
- 15) The oven should be cleaned daily, follow the cleaning procedures in section 9 of this manual.
- 16) To reduce the risk of fire in the oven cavity:
 - i. do not overcook food. Carefully attend appliance when paper, plastic, or other combustible materials are placed inside the oven to facilitate cooking.
 - ii. remove wire twist-ties from paper or plastic bags before placing a bag in the oven.
 - iii. if materials inside the oven ignite, keep the oven door closed. Turn the oven off, and disconnect the supply cord, or shut off power at the fuse or circuit breaker panel.
 - iv. do not use the cavity for storage purposes. Do not leave paper products, cooking utensils or food in the cavity when not in use.

17) Liquids, such as water, coffee or tea are able to be overheated beyond the boiling point without appearing to be boiling. Visible bubbling or boiling when the container is removed from the microwave combination oven is not always present. THIS COULD RESULT IN VERY HOT LIQUIDS SUDDENLY BOILING OVER WHEN THE CONTAINER IS DISTURBED OR A UTENSIL IS INSERTED INTO THE LIQUID.

Combination microwave ovens



- 1) Oversized foods or oversized metal utensils should not be inserted in a microwave oven as they may create a fire or risk of electric shock.
- 2) Do not clean with metal scouring pads. Pieces can burn off the pad and touch electrical parts involving a risk of electric shock.
- 3) Do not store any materials, other than the manufacturer’s recommended accessories in this oven when not in use.
- 4) Do not cover racks or any other part of the oven with metal foil. This will cause overheating of the oven.

SAVE THESE INSTRUCTIONS

| | |
|---|--|
|  | <p>WARNING Improper installation, adjustment, alteration, service or maintenance can cause property damage, injury and death. Read the installation, operating and maintenance instructions thoroughly before installing or servicing this equipment.</p> |
|  | <p>WARNING PRECAUTIONS TO AVOID POSSIBLE EXPOSURE TO EXCESSIVE MICROWAVE ENERGY</p> <ul style="list-style-type: none"> ▶ Do not attempt to operate this oven with the door open since open-door operation can result in harmful exposure to microwave energy. It is important not to defeat or tamper with the safety interlocks. ▶ Do not place any object between the oven front face and the appliance door or allow soil or cleaner residue to accumulate on sealing surfaces. ▶ Do not operate the oven if it is damaged. It is particularly important that the oven door closes properly and that there is no damage to the (1) door (bent), (2) hinges and latches (broken or loosened), (3) door seals and sealing surfaces. ▶ The oven should not be adjusted or repaired by anyone except properly qualified service personnel. |
|  | <p>WARNING Disconnect power at the main external power switch before servicing or repairing a microwave combination oven.</p> |
|  | <p>WARNING To reduce the risk of electric shock, do not remove or open cover. No user serviceable parts inside. Refer servicing to qualified personnel. Disconnect power supply before servicing.</p> |
|  | <p>WARNING This is a class A product. In a domestic environment this product may cause radio interference in which case the user may be required to take adequate measures.</p> |



■ Mandatory warning signs

The following warning signs / notices must be attached to the microwave combination oven and optional accessories in the area indicated so as to be easily visible at all times.

| Warning sign | Description |
|---|---|
|  | Microwaves warning (US and Canada only) There is a risk of external and internal burns of body parts following exposure to microwave energy. |
|  | Hot surface warning There is a risk of burns from high temperatures inside the cavity and on the inside of the appliance door. |

■ Safety symbols

The following safety symbols must be attached to the microwave combination oven in the area indicated so as to be easily visible at all times.

| Safety symbol | Description |
|---|---------------------------|
|  | Protective Earth (Ground) |
|  | Equipotential bonding |

Customer documentation

- The customer documentation is part of the microwave combination oven.
- Keep the customer documentation manuals handy at all times so that you can look up any required information.
- Keep the customer documentation manuals for the entire life of the appliance.
- Carefully read the Installation and User Manual before using, handling, and working on this appliance.
- If you transfer the microwave combination oven to a new owner, make sure to give the new owner the customer documentation manuals as well.

Contents

| | | |
|----------|---|-----------|
| 1 | General information | 7 |
| 1.1 | CE and UKCA declarations of conformity | 7 |
| 1.1.1 | CE declaration of conformity | 7 |
| 1.1.2 | UKCA declaration of conformity | 7 |
| 1.1.3 | UL declaration of conformity | 7 |
| 1.1.4 | For other approval requirement please contact your local Merrychef representative | 7 |
| 1.2 | Environmental protection | 8 |
| 1.3 | Important Information | 8 |
| 1.4 | Identifying your microwave combination oven | 9 |
| 1.5 | Structure of customer documentation | 9 |
| 1.6 | About this Installation and User Manual | 10 |
| 2 | Design and function | 12 |
| 2.1 | Design and function of the microwave combination oven | 12 |
| 2.2 | Layout and function of the operating panel | 13 |
| 3 | For your safety | 14 |
| 3.1 | Basic safety code | 14 |
| 3.2 | Intended use of your microwave combination oven | 14 |
| 3.3 | Warning signs on your microwave combination oven | 15 |
| 3.4 | Summary of hazards | 16 |
| 3.5 | Safety devices | 17 |
| 3.6 | Requirements to be met by personnel and working positions | 18 |
| 3.7 | Personal protective equipment | 19 |
| 4 | Moving the appliance | 21 |
| 4.1 | Working safely with the appliance | 21 |
| 4.2 | Moving the appliance to the installation location | 22 |
| 5 | Setting up the appliance | 23 |
| 5.1 | Safe working when setting up the appliance | 23 |
| 5.2 | Requirements for the installation location | 24 |
| 5.3 | Unpacking the appliance | 26 |
| 5.4 | Taking the appliance off the pallet | 28 |
| 5.5 | Mounting an appliance on a work surface | 29 |
| 6 | Installation | 30 |
| 6.1 | Safe working during electrical installation | 30 |
| 6.2 | Planning the electrical installation | 30 |
| 6.3 | Electrical installation requirements | 32 |
| 7 | Preparing the appliance for use | 35 |
| 7.1 | Safe working when preparing the appliance for use | 35 |
| 7.2 | Procedure for preparing the appliance for use | 36 |
| 7.3 | Main menu screen | 38 |
| 7.4 | The keyboard screen | 39 |

| | | |
|-----------|---|-----------|
| 8 | Cooking procedures | 40 |
| 8.1 | Operating principles and instructions for cooking | 40 |
| 8.1.1 | Working safely with the appliance | 40 |
| 8.1.2 | Turning the oven on and off | 41 |
| 8.1.3 | How to cook | 42 |
| 8.2 | Operation instructions: Full serve mode | 44 |
| 8.2.1 | The Press & Go Menu | 44 |
| 8.2.2 | Using a cooking profile | 45 |
| 8.2.3 | Creating a cooking profile | 46 |
| 8.2.4 | Changing a cooking profile | 49 |
| 8.2.5 | Managing categories of cooking profile | 52 |
| 8.2.6 | Basic settings of your microwave combination oven | 54 |
| 8.2.7 | Using a USB stick | 63 |
| 9 | Cleaning procedures | 64 |
| 9.1 | Daily cleaning tasks | 64 |
| 9.2 | Cleaning chemicals | 64 |
| 9.3 | Items required for cleaning | 65 |
| 9.4 | Safe working when cleaning | 65 |
| 9.5 | Cleaning procedures | 67 |
| 9.5.1 | Cool down procedure before cleaning | 67 |
| 10 | Taking the appliance out of operation and disposal | 71 |
| 10.1 | Safe working when taking the appliance out of operation | 71 |
| 10.2 | Taking the appliance out of operation and disposal | 72 |
| 11 | Technical data | 73 |
| 11.1 | Technical data | 73 |
| 11.2 | Dimensional drawings | 77 |
| 12 | Servicing information | 78 |
| 12.1 | Warranty information and contacting customer service | 78 |
| 12.2 | Rectifying faults: problems in operation | 79 |

1 General Information

Purpose of this chapter

This chapter shows you how to identify your microwave combination oven and provides guidance on using this manual.

1.1 CE and UKCA declarations of conformity

1.1.1 CE declaration of conformity



The manufacturer declares that the Microwave Combination Oven complies with the following European Directives:

- 2006/42/EC (Machinery Directive)
- 2014/30 (EMC Directive)
- 2011/65/EU (RoHS Directive)
- 2014/53/EU (Radio Equipment Directive)

A full Declaration of Compliance is available on request.

1.1.2 UKCA declaration of conformity



The manufacturer declares that the Microwave Combination Oven specified above complies with the following UK Statutory Instruments:

- UKSI 2008 No. 1597 - Supply of Machinery (Safety) Regulations 2008
- UKSI 2016 No. 1091 - Electromagnetic Compatibility Regulations 2008
- UK SI 2012 No. 3032 - RoHS Regulations 2012
- Radio Equipment Regulations 2017

A full Declaration of Compliance is available on request.

1.1.3 UL declaration of conformity



1.1.4 For other approval requirements please contact your local Merrychef representative

1.2 Environmental protection

Statement of principles

Our customers' expectations, the legal regulations and standards and our company's own reputation set the quality and service for all our products.

We have an environmental management policy that not only ensures compliance with all environmental regulations and laws, but also commits us to continuous improvement of our green credentials.

We have developed a quality and environmental management system in order to guarantee the continued manufacture of high-quality products and to be sure of meeting our environmental targets.

This system satisfies the requirements of ISO 9001:2008 and ISO 14001:2004.

Environmental protection procedures

- We observe the following procedures:
- Use of RoHS3 compliant products
- REACH chemical law
- Recycling of electronic waste
- Environmentally friendly disposal of old appliances via the manufacturer

Join us in our commitment to protect the environment.

1.3 Important information

Users are cautioned that maintenance and repairs should be performed by a Merrychef® authorised service agent using genuine Merrychef® replacement parts. Merrychef® will have no obligation with respect to any product that has been improperly installed, adjusted, operated or not maintained in accordance with national and local codes or installation instructions provided with the product, or any product that has its serial number defaced, obliterated or removed, or which has been modified or repaired using unauthorised parts or by unauthorised service agents. For a list of authorised service agents please refer to your distributor.

1.4 Identifying your microwave combination oven

Position of nameplate

The nameplate is located on the rear of your microwave combination oven.

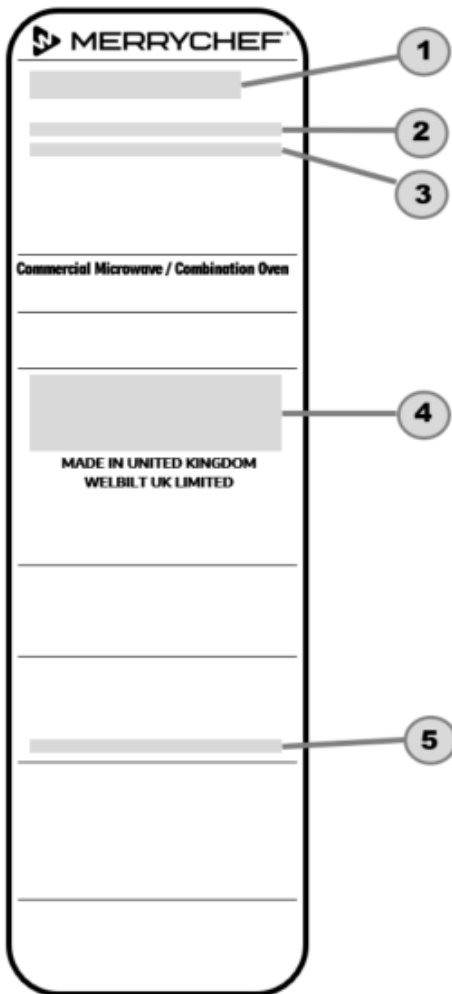

1 Model number

conneX12 & conneX16

2 Item Number

Elements of the item number

| Label | Meaning |
|-------------------------|---|
| Model | X12 or X16 |
| Power output convection | D 2200W F 2200W / 1300W G 2200W / 900W S 3200W (conneX16 only) |
| Power output microwave | B 2000W (High Power version) X 1000W (Standard Power version) |
| Voltage | 30 230V MV5 220-230V / 50Hz MV6 208 / 240V / 60Hz 00 200V 20 220V |
| Frequency | 5 50Hz 6 60Hz |
| Lead | A - Z Example: H = L+N+E (4mm EU) |
| Plug | A - Z Example: E = 32A 1ph plug |
| Communication | L LAN / WiFi |
| Version | A, B A, B (pre-production) 1, 2, ... 1, 2, ... (serial production) |
| Accessory / Customer | WW Specific customer |
| Region / Country | EU Europe US United States of America |

3 Serial Number

Elements of the serial number

| Label | Meaning |
|----------------------|---------------------------|
| Year of manufacture | 21 2021 22 2022 |
| Month of manufacture | 01 January 02 February |
| Place of manufacture | 2130 Sheffield (UK) |
| Production number | 12345 |

4 Technical data

5 Date of manufacture

1.5 Structure of customer documentation

Contents of customer documentation

The customer documentation for the microwave combination oven includes the following documents:

- Installation and User Manual (this document)

1.6 About this Installation and User Manual

Purpose

This Installation and User Manual is intended for all people who work with the microwave combination oven and provides them with the necessary information for carrying out installation, operating tasks, cleaning jobs and minor servicing work properly and safely.

Who should read the Installation and User Manual?

| Name of target group | Tasks |
|---|---|
| Equipment mover | Conveying within the establishment. |
| Service technician | <ul style="list-style-type: none"> ▪ Setting up the appliance. ▪ Preparing the appliance for first-time use and taking the appliance out of service. ▪ Instructing the user. |
| Owner of the microwave combination oven or Owner's member of staff who is responsible for the appliance | <ul style="list-style-type: none"> ▪ Made aware of all safety-related functions and devices of the microwave combination oven by the service technician. ▪ Instructed by the service technician on how to operate the appliance. ▪ Provides assistance as instructed with conveying the appliance within the establishment and setting up the appliance. |
| User | <p>Essentially performs specific operating tasks such as</p> <ul style="list-style-type: none"> ▪ Loading the microwave combination oven. ▪ Starting cooking profiles. ▪ Removing food. ▪ Cleaning the microwave combination oven. ▪ Fitting accessories in the microwave combination oven. ▪ Minor servicing tasks. |

Parts of this documentation that must be read without fail

If you do not follow the information in this document, you risk potentially fatal injury and property damage.

To guarantee safety, all people who work with the microwave combination oven must have read and understood the following parts of this document before starting any work:

- Chapter 3 '*For your safety*'
- The sections that describe the activity to be carried out

■ Chapters in the Installation and User Manual

| Chapter/section | Purpose |
|--|--|
| General information | <ul style="list-style-type: none"> ▪ Shows you how to identify your appliance. ▪ Provides guidance on using this Installation and User Manual. |
| Design and function | <ul style="list-style-type: none"> ▪ Specifies the intended use of the appliance. ▪ Explains the functions of the appliance and shows the position of its components. |
| For your safety | <ul style="list-style-type: none"> ▪ Describes the hazards posed by the appliance and suitable preventive measures. ▪ It is important that you read this chapter carefully. |
| Moving the appliance | <ul style="list-style-type: none"> ▪ Specifies the basic appliance dimensions. ▪ Specifies the requirements for the installation position. ▪ Explains how to convey the appliance to the installation position. |
| Setting up the appliance | <ul style="list-style-type: none"> ▪ Explains how to unpack the appliance and specifies the parts supplied with the appliance. ▪ Explains how to set up the appliance. |
| Installation | Provides information on installing the electrical supply. |
| Preparing the appliance for use | Explains the procedure for preparing the appliance for first-time use. |
| Cooking procedures | <ul style="list-style-type: none"> ▪ Explains how to switch on the microwave combination oven. ▪ Contains the instructions for working procedures during cooking. ▪ Contains the instructions for handling operations on the microwave combination oven regularly performed during cooking. |
| Cleaning procedures | <ul style="list-style-type: none"> ▪ Contains the cleaning instructions. ▪ Describes the cleaning chemicals. ▪ Contains and refers to the instructions for handling operations on the microwave combination oven regularly performed during cleaning. |
| Taking the appliance out of operation and disposal | <ul style="list-style-type: none"> ▪ Explains the procedure for taking the appliance out of service. ▪ Contains information on disposal. |
| Technical data | Contains the technical data and dimensional drawings. |
| Servicing information | Contains Warranty information and a key to rectifying problems in operation. |

2 Design and function

Purpose of this chapter

This chapter describes the design and construction of the microwave combination oven and explains its functions.

2.1 Design and function of the microwave combination oven

Parts and their function



| Item | Name | Function |
|------|---------------------------------|---|
| 1 | ON/OFF onscreen icon | Used to turn the microwave combination oven on and off. Pressing this icon off does not isolate the appliance from the electricity supply. |
| 2 | easyTouch® screen control panel | When the appliance is switched on the easyTouch® screen illuminates the user interface. See 'Cooking procedures' section 8, for details. |
| 3 | Nameplate (no picture) | Located on the rear panel of the appliance, the nameplate states the serial number, model type and electrical specifications. |
| 4 | USB port | A USB socket located under the air filter cover allows updates to programs stored on the appliance. See using a USB stick, section 8.2.7 See 'Cooking procedures' section 8, for details of updating cooking profiles. |
| 5 | Air outlets (no picture) | Air used to cool internal components and steam from the cavity escape through the air outlet vents located on the rear of the appliance. The air outlets must be kept free from obstruction, and they will not allow microwave energy to escape into the environment. |
| 6 | Appliance door | The door is a precision-made energy barrier with three microwave safety interlocks. Always keep it clean and do not use it to support heavy objects. See 'Cleaning procedures' section 9. |
| 7 | Air filter | The air filter situated at the lower front of the appliance is part of the ventilation system. Keep it free of obstruction and clean it daily as described under 'Cleaning procedures' section 9. The appliance should not be operated without the air filter fitted. |
| 8 | Door handle | The door handle is a rigid bar which is pulled downwards and away from the appliance to open it. |
| 9 | Door seals | The door seals ensure a tight seal around the door. Always keep them clean and check regularly for signs of damage. At the first sign of wear have them replaced by a Merrychef® approved service agent. See 'Cleaning procedures' section 9. |
| 10 | Air diffuser | Keep the air diffuser clean and free of debris. Take great care when cleaning this area of the appliance noting the different requirements shown under 'Cleaning procedures' section 9. |
| 11 | Cavity | The cavity (cooking chamber) is constructed from stainless steel and used for cooking products. Keep it clean by following the cleaning instructions in the 'Cleaning procedures' section 9. |

| Item | Name | Function |
|------|------------|---|
| 12 | Cook plate | The cook plate is flat and square with all four sides having circular dips for easily fitting onto the cavity support stubs (two on each side). Both sides of the cook plate can be used for cooking and all sides are designed to fit onto the cavity support stubs. |

Material

The interior and exterior structure of the appliance is made of stainless steel in either a brushed finish or carbon black.

2.2 Layout and function of the operating panel

Elements and their function

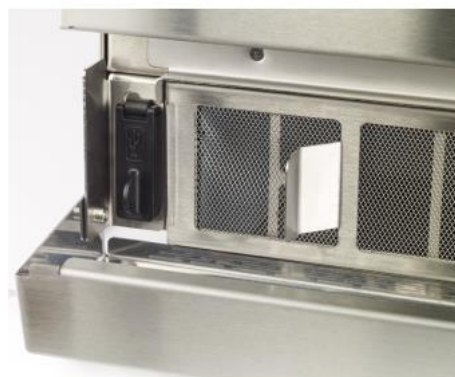

| Item | Name | Function |
|------|-----------------------|--|
| 1 | ON/OFF on screen icon | Switches the microwave combination oven on and off. |
| 2 | Touchscreen | Central controls of the appliance <ul style="list-style-type: none"> ▪ Appliance operated by touching icons on touchscreen pages. ▪ Status displays. |
| 3 | USB port | For connecting a USB memory stick. |

3 For your safety

■ Purpose of this chapter

Together with Important Safety Instructions on pages 2-3, this chapter provides you with all the information you need in order to use the microwave combination oven safely without putting yourself or others at risk.

This is a particularly important chapter that you must read through carefully.

! 3.1 Basic safety code

■ Object of this safety code

This safety code aims to ensure that all persons who use the microwave combination oven have a thorough knowledge of the hazards and safety precautions, and that they follow the warning notices given in this Installation and User Manual and on the appliance. If you do not follow this safety code, you risk potentially fatal injury and property damage.

! 3.2 Intended use of your microwave combination oven

The microwave combination oven must only be used for the purposes specified below:

- The microwave combination oven is designed and built solely for cooking different foodstuffs in containers approved by the manufacturer. Microwave, convection and impingement are used for this purpose.
- The microwave combination oven is intended solely for professional, commercial use.

■ Restrictions on use

Some materials are not allowed to be heated in the microwave combination oven:

- No dry powder or granulated material.
- No highly flammable objects with a flash point below 275°C / 528°F, such as highly flammable oils, fats or cloths (kitchen cloths).
- No food in sealed tins or jars.

■ Requirements to be met by personnel

- The microwave combination oven must only be operated and installed by personnel who satisfy specific requirements. Please refer to '*Requirements to be met by personnel, working positions*' section 3.6, for the training and qualifications requirements.
- Personnel must be aware of the risks and regulations associated with handling heavy loads.

■ Requirements relating to the operating condition of the microwave combination oven

- Do not operate the microwave combination oven unless it has been properly transported, set up, installed and placed into operation as indicated in this manual and the person responsible for placing it into operation has confirmed this.
- The microwave combination oven must only be operated when all safety devices and protective equipment are fitted, in working order and fixed properly in place.
- The manufacturer's regulations for operation and servicing of the microwave combination oven must be observed.

■ Requirements relating to the operating environment of the microwave combination oven

Specified operating environment for the microwave combination oven:

- The ambient temperature lies between +4°C / 40°F and +35°C / 95°F.
- Not a toxic or potentially explosive atmosphere.
- Dry kitchen floor to reduce the risk of accidents.

Specified properties of the installation location:

- No fire alarm, no sprinkler system directly above the appliance.
- No flammable materials, gases or liquids above, on, under or in the vicinity of the appliance.
- It must be possible to set up the microwave combination oven in the installation position so that it cannot tip over or slide about. The supporting surface must comply with these requirements.

Mandatory restrictions on use:

- The appliance must not be operated outdoors and not be shifted or moved during use.
- The appliance must not be installed or operated on vessels or in close proximity to sandy areas such as beach kiosks.

■ Cleaning requirements

- Use only cleaning chemicals that have been approved by the manufacturer.
- High-pressure cleaners or water jets must not be used for cleaning.
- The appliance must not be treated with alkali or acid solutions or exposed to acid fumes.



3.3 Warning signs on your microwave combination oven

■ Warning and safety signs

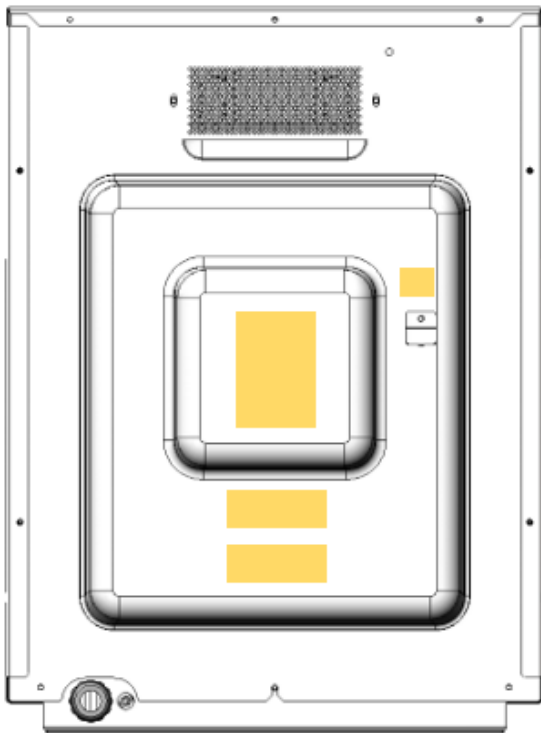
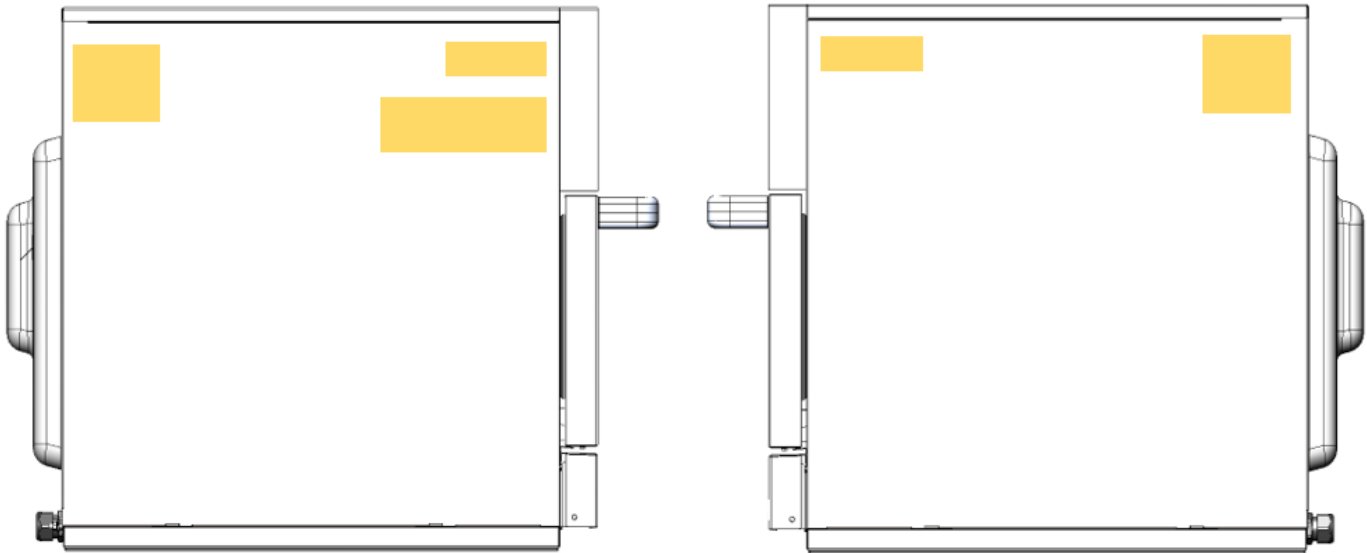

The ovens have warning/hazard labels attached to the outer casework which can be found as shown in the diagrams.

Ensure you are aware and take notice of all these warning and safety signs.



3.4 Summary of hazards

■ General rules for dealing with hazards and safety precautions

The microwave combination oven is designed to protect the user from all hazards that can reasonably be avoided by design measures.

The actual purpose of the microwave combination oven, however, means that there are still residual risks; you must therefore take precautions to avoid them. A safety device can provide you with a certain degree of protection against some of these hazards. You must ensure, however, that these safety devices are in place and in working order.

The nature of these residual risks and what effect they have are described on the following pages.



■ Hazard points

The following illustration shows a Merrychef conneX® X12 microwave combination oven:

■ Excessive microwave energy

The microwave combination oven generates microwave energy. An operation with an open or damaged door or cavity can result in external and internal burns of body parts following exposure to microwave energy.

■ Heat generation (1)

The microwave combination oven becomes hot inside the cavity and on the inside of the appliance door. This poses a risk of burns on hot surfaces inside the microwave combination oven, and also on hot appliance parts, food containers and other accessories used for cooking.

■ Hot steam / vapour (2)

When cooking food, the microwave combination oven may generate hot steam and vapour which escapes when the appliance door is opened, and which is removed through the air vents on the rear of the microwave combination oven when the appliance door is closed. This poses a risk of scalding from hot steam when the appliance door is opened. Take particular care when opening the appliance door if the top door edge is below your field of vision.

■ Hot liquids

Foodstuffs are cooked in the microwave combination oven. These foodstuffs may also be liquid or liquefy during cooking. This poses a risk of scalding from hot liquids, which may be spilled if not handled properly.

■ Live components (3)

The microwave combination oven contains live parts. This means a risk from live parts if the cover is not in place.

■ Contact with cleaning chemicals

The microwave combination oven must be cleaned using special cleaning chemicals. This poses a risk from cleaning chemicals, some of which can cause skin burns.

■ Parts moving against each other (4)

For various actions, such as opening/shutting the appliance door or cleaning the appliance door, there is the risk that you will crush or cut your hand.

■ Undercooking of food products

Ensure all food is hot before serving to protect your guests from microbiological contamination of foodstuffs.

! 3.5 Safety devices

■ Meaning

The microwave combination oven has a number of safety devices to protect the user from hazards. It is absolutely essential that all safety devices are fitted and in working order when operating the appliance.

■ Position and function



| Item | Safety device | Function | Check |
|------|--|--|---|
| 1 | Covers can only be removed using a tool | <ul style="list-style-type: none"> ▪ Prevents live parts from being touched accidentally ▪ Prevents access to the moving fan from the wiring compartment | Check that the covers are in place. |
| 2 | Operating panel can only be removed using a tool | Prevents live parts from being touched accidentally | Ensure that the operating panel is in place. |
| 3 | Door seal | Protects the user from steam leaking from the cavity | Check the door seal regularly for signs of damage and replace it if required. |
| 4 | Appliance door | Protects the user and outside environment from hot steam and microwave energy | Check the door regularly for damage and replace it if required. |

| Item | Safety device | Function | Check |
|---|--|---|---|
| 5 (no picture) | Door interlocks: three switch circuit for the appliance door | Ensures that the microwave generation system cannot be powered when the door is open. | Check door switches: Action: Open the appliance door fully during pre-heat or when the oven is at temperature Result: Door open warning message displayed |
| 6 (no picture, installed by customer) | Disconnection device | <ul style="list-style-type: none"> ▪ Installed by the customer close to the appliance; easily visible and accessible, 1- or 3-pole action, minimum contact separation 3 mm. ▪ Used to disconnect the appliance from the power supply during cleaning, repair and servicing work and in case of danger | Action: <ul style="list-style-type: none"> ▪ Trip the disconnection device |
| 7 (no picture) | Internal fuses | Prevent faulty components from drawing too much current and causing a potential fire hazard. | Ensure that the internal fuses are correctly rated, actioned by an authorised service company technician only |
| 8 (no picture) | Internal high temperature thermostats | Prevent faulty components from generating too much heat and causing a potential fire hazard | Ensure correct operation, actioned by an authorised service company technician only |



3.6 Requirements to be met by personnel and working positions

Requirements to be met by operating personnel

| Personnel | Qualifications | Tasks |
|-----------------|--|--|
| Chef | <ul style="list-style-type: none"> ▪ Has relevant professional training ▪ Knows relevant national food legislation and regulations, plus hygiene legislation and regulations ▪ Must keep records in accordance with HACCP ▪ Trained in how to operate the microwave combination oven | Essentially performs organizational tasks such as <ul style="list-style-type: none"> ▪ Entering the cooking profile data ▪ Editing existing cooking profiles in the cookbook ▪ Developing new cooking profiles ▪ Adjusting appliance settings May also perform all user tasks if applicable. |
| User | <ul style="list-style-type: none"> ▪ Semi-skilled ▪ Trained in how to operate the microwave combination oven ▪ Works under supervision ▪ Knows the regulations associated with handling heavy loads | Essentially performs specific operating tasks such as <ul style="list-style-type: none"> ▪ Loading the microwave combination oven ▪ Starting a cooking profile ▪ Removing food ▪ Cleaning the microwave combination oven ▪ Fitting accessories in the microwave combination oven ▪ Minor servicing tasks |
| Equipment mover | <ul style="list-style-type: none"> ▪ Trained in the use of a pallet truck and forklift truck ▪ Knows the regulations associated with handling heavy loads | Conveying within the establishment. |

| Personnel | Qualifications | Tasks |
|--------------------|---|---|
| Service technician | <ul style="list-style-type: none"> ▪ Is an authorised service agent ▪ Has relevant technical training ▪ Is trained in the particular appliance ▪ Knows the regulations associated with handling heavy loads | <ul style="list-style-type: none"> ▪ Setting up the appliance ▪ Preparing the appliance for first-time use and taking the appliance out of service. ▪ Instructing the user |

Working positions

- The working position for personnel installing and preparing the appliance for first-time use is the entire appliance area.
- The working position for personnel when operating the appliance is in front of the appliance door.
- The working position for staff during cleaning and servicing is the entire appliance area.

3.7 Personal protective equipment

Moving and setting up the appliance

| Activity | Materials used | Personal protective equipment |
|---|---|--|
| <ul style="list-style-type: none"> ▪ Conveying within the establishment ▪ Setting up the appliance on a work surface, stand or in a stacking kit ▪ Setting up the appliance in the installation location | <ul style="list-style-type: none"> ▪ Suitable lifting gear ▪ Forklift truck or pallet truck | <ul style="list-style-type: none"> ▪ Protective gloves ▪ Safety boots ▪ Hard hat (e.g., when heavy loads are being lifted, working overhead, ...) |

Installation, preparing for the first-time use and taking out of service

| Activity | Materials used | Personal protective equipment |
|--|---|---|
| Installing and removing (taking out of operation) the electrical connection | Tools and equipment depending on the task | Work wear and personal protective equipment depending on the job that needs doing as specified in national regulations. |
| <ul style="list-style-type: none"> ▪ Preparing the appliance for first-time use ▪ Instructing the user | Tools and equipment depending on the task | Workwear as specified in country-specific standards and directives for kitchen work, in particular: <ul style="list-style-type: none"> ▪ Protective clothing ▪ Heat protective gloves (compliant with EN 407 in European Union) ▪ Safety boots |
| Dismantling the appliance (taking out of operation) | <ul style="list-style-type: none"> ▪ Suitable lifting gear ▪ Forklift truck or pallet truck | <ul style="list-style-type: none"> ▪ Protective gloves ▪ Safety boots ▪ Hard hat (e.g., when heavy loads are being lifted, working overhead). |

■ Operation

| Activity | Materials used | Personal protective equipment |
|----------------------------|--|---|
| Loading / removing food | None | Workwear as specified in country-specific standards and directives for kitchen work, in particular: <ul style="list-style-type: none"> ▪ Protective clothing ▪ Heat protective gloves (compliant with EN 407 in European Union) ▪ Safety boots |
| Removing and fitting parts | Tools and equipment depend on the task | Workwear as specified in country-specific standards and directives for kitchen work, in particular: <ul style="list-style-type: none"> ▪ Protective clothing ▪ Heat protective gloves (compliant with EN 407 in European Union) ▪ Safety boots |

■ Cleaning

| Activity | Materials used | Personal protective equipment |
|---|--|---|
| <ul style="list-style-type: none"> ▪ Cleaning the cavity by hand ▪ Handling spray bottles | <ul style="list-style-type: none"> ▪ Cleaning chemicals approved by the manufacturer ▪ Protective chemicals approved by the manufacturer | Items of protection equipment, depending on cleaning chemical being used: <ul style="list-style-type: none"> ▪ Breathing mask ▪ Safety goggles ▪ Protective gloves ▪ Protective clothing/apron The material safety datasheet for the relevant cleaning chemical contains a more precise specification of these items. An up-to-date copy can be obtained from the manufacturer. Refer to the label on the cleaning chemical concerned. |
| Cleaning components and accessories according to relevant instructions | Common household detergent: mild on skin, alkali-free, pH-neutral and odourless | Follow the instructions given by the manufacturer of the cleaning chemical you are using. |
| Cleaning the outside of the appliance case | Common household stainless steel cleaner or hard surface cleaner | Follow the instructions given by the manufacturer of the cleaning chemical you are using. |

4 Moving the appliance

■ Purpose of this chapter

Provides information on how to move the appliance.

This chapter is intended for the owner's member of staff responsible for the appliance and for a qualified member of staff from an authorized service company.

■ 4.1 Working safely with the appliance

■ Eligibility of personnel for moving the appliance

Personnel eligible for moving the appliance:

- Only personnel who are trained in the use of a pallet truck and fork-lift truck for handling purposes are permitted to move the appliance.
- Personnel must be aware of the regulations relating to handling heavy loads.

■ Personal protective equipment

Wear the following personal protective equipment specified in the section '*Personal protective equipment*' section 3.7 of the '*For your safety*' chapter for the relevant tasks.

■ Moving heavy loads

WARNING

Risk of injury from lifting incorrectly

When lifting the appliance, the weight of the appliance may lead to injuries, especially in the area of the torso.

- ▶ Use a fork-lift truck/pallet truck to move the appliance.
- ▶ When lifting the appliance, use enough people for the weight of the appliance (value depending on age and gender). Observe the local occupational safety regulations.
- ▶ Wear personal protective equipment.

■ Unsuitable supporting surface

WARNING

Risk of crushing if the appliance tips over or falls off

Body parts can be crushed if the appliance tips over or falls off.

- ▶ Make sure that the appliance is never placed on an unsuitable supporting surface.

4.2 Moving the appliance to the installation location

Space required for conveying the appliance

Make sure that there is enough width and height along the entire route used for conveying the appliance to ensure it can get through to its installation location.

The table below shows the dimensions of the **appliance including packaging**, which are needed to determine the minimum doorway dimensions required to allow the appliance to be brought to its installation location:

Minimum door opening

conneX 12

| | | | | |
|--------|------|-----|------|------|
| Width | [mm] | 520 | [in] | 20.5 |
| Height | [mm] | 855 | [in] | 33.7 |
| Depth | [mm] | 820 | [in] | 32.3 |

conneX 16

| | | | | |
|--------|------|-----|------|------|
| Width | [mm] | 620 | [in] | 24.4 |
| Height | [mm] | 855 | [in] | 33.7 |
| Depth | [mm] | 820 | [in] | 32.3 |

Load bearing capability for conveying the appliance

Provide moving equipment that is rated capable of carrying the load.

Empty weight of the appliance

| | | | | |
|----------------------------------|------|------|-------|-----|
| ConneX 12 High Power version | [kg] | 68.7 | [lbs] | 151 |
| ConneX 12 Standard Power version | [kg] | 60.0 | [lbs] | 133 |
| ConneX 16 version | [kg] | 79.2 | [lbs] | 175 |

Moving the appliance to the installation location

Please observe the following points when conveying the appliance:

- Always move the appliance on a pallet.
- Always move the appliance in an upright position.
- Move the appliance slowly and carefully and secure it against tipping over.
- Make sure that you do not knock against things with the appliance.
- Avoid moving the appliance along uneven routes or up or down slopes/steps.
- Do not lift the oven by the handle but always use the hand lifting points.

5 Setting up the appliance

■ Purpose of this chapter

Provides information on how to set up your appliance.

This chapter is intended for the user and for a qualified member of staff from an authorized service company.

5.1 Safe working when setting up appliance

■ Eligibility of personnel for setting up the appliance

Personnel eligible for setting up the appliance:

- Only qualified personnel from an authorized service company are permitted to set up the appliance.

■ Regulations for setting up the appliance

Local and national standards and regulations relating to workplaces in catering kitchens must be observed.

The rules and regulations of the local authorities and supply companies that apply to the installation location concerned must be observed.

■ Personal protective equipment

Wear the following personal protective equipment specified in the section '*Personal protective equipment*' section 3.7 of the '*For your safety*' chapter for the relevant tasks.

■ Moving heavy loads

WARNING

Risk of injury from lifting incorrectly

When lifting the appliance, the weight of the appliance may lead to injuries, especially in the area of the torso.

- ▶ Use a forklift truck or pallet truck to place the appliance in the installation position or to move it to a new position.
- ▶ When shifting the appliance into the correct position, use enough people for the weight of the appliance when lifting it (value depending on age and gender). Observe the local occupational safety regulations.
- ▶ Wear personal protective equipment.

■ Unsuitable supporting surface

WARNING

Risk of crushing if the appliance tips over or falls off

Body parts can be crushed if the appliance tips over or fall off.

- ▶ Make sure that the appliance is never placed on an unsuitable supporting surface.

5.2 Requirements for the installation location

Meaning

This section contains information to help you choose a suitable installation location for the microwave combination oven. Inspect the intended installation location carefully to ensure it is suitable before taking the appliance there and starting the installation.

⚠ Rules for setting up the appliance safely

To prevent hazards that arise from the installation site and environment of the appliances, the following rules must be observed:

- It must be possible to comply with the operating conditions. For operating conditions, see '*Requirements relating to the operating environment of the microwave combination oven*' section 3.2.
- There is a risk of fire from the heat emitted from hot surfaces. Therefore, flammable materials, gases or liquids must not be located near on or below the appliance. When choosing where to install the appliance it is essential to remember this requirement together with the minimum space required for the appliance.
- Heat sources in the vicinity must lie at a minimum distance of 500 mm / 20 in.
- The appliance must be installed so that there is absolutely no possibility that liquid from the appliance or liquid coming from cooking processes can reach deep-fat fryers or appliances that use hot, uncovered fat. Deep-fat fryers or appliances that use hot, uncovered fat that are located in the vicinity must lie at a minimum distance of 500 mm / 20 in.
- The appliance must not be installed directly under a fire alarm or sprinkler system. Fire alarm installations and sprinkler systems must be set up to handle the level of steam and vapour expected to escape from the appliance when the door is opened.
- It must be possible to set up the supporting structure for the appliance (work surface, stand or stacking kit) in the installation position so that it cannot tip over or slide about. The supporting surface must satisfy the requirements listed below.
- Vibrations must generally be avoided when using wheeled oven stands or wheeled stacking kits.

Requirements for the supporting surface

The supporting surface must have the following properties:

- The supporting surface must be flat and level.
- The supporting surface must be able to bear the in-use weight of the appliance plus the weight of the structure supporting the appliance.
- The structure supporting the appliance (work surface or stand) must be able to bear the in-use weight of the appliance.

Empty weight of the appliance

| | | | | |
|----------------------------------|------|------|-------|-----|
| ConneX 12 High Power version | [kg] | 58.7 | [lbs] | 130 |
| ConneX 12 Standard Power version | [kg] | 50.0 | [lbs] | 111 |
| ConneX 16 version | [kg] | 67.2 | [lbs] | 148 |

Actual space requirements

Far more room than the specified minimum space requirement is needed in front of the appliances to operate the microwave combination ovens safely, in particular, to handle hot food safely.

Larger wall gaps are generally recommended to provide access for servicing.

In the installation location, the following parts must not be covered, adjusted or blocked (see also '*Design and function of the microwave combination oven*' section 2.1):

- Air vent on the rear of the appliance
- Air filter at the front of the appliance

Consideration should be given to allow sufficient access for the service and maintenance of the appliance and access to the power supply isolator.

■ Minimum space required

The following diagram and table show the space required for the appliance for different installation and operating situations. They also show the minimum horizontal distances from adjacent walls and surfaces. The safety clearance on the top must always be complied with.

| Meaning | | Space required | | | |
|----------|---|----------------|-----|------|------|
| A | Safety clearance from the top | [mm] | 50 | [in] | 2 |
| | Depth requirement, appliance door open at 90° | [mm] | 310 | [in] | 12.2 |
| | Safety clearance on left-/right-hand side | [mm] | 0 | [in] | 0 |

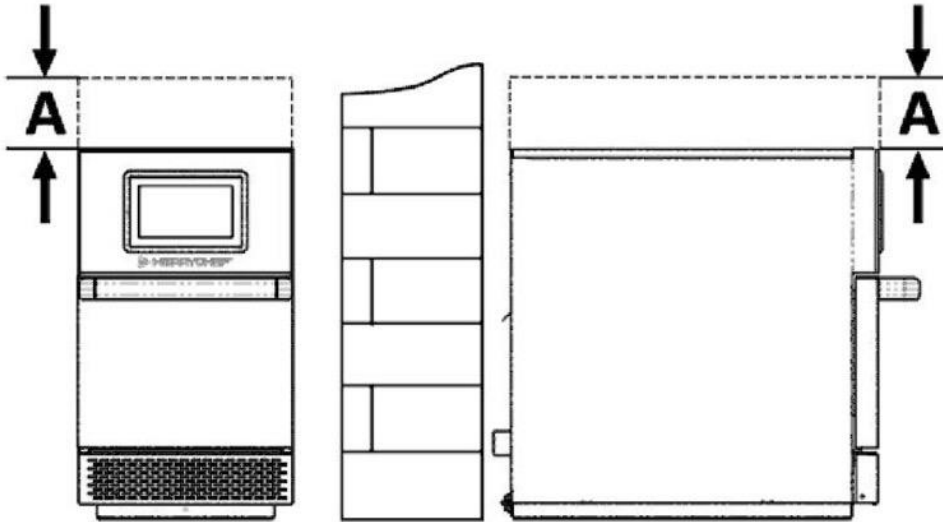

5.3 Unpacking the appliance

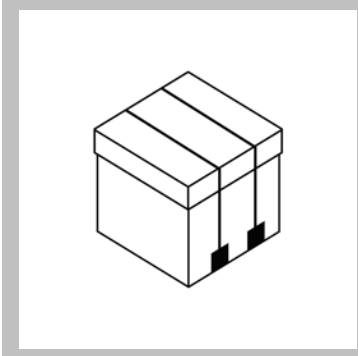
1. 

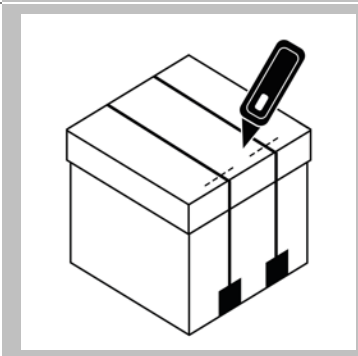
Take delivery of boxed appliance. Inspect the appliance for damage before signing the delivery note. Record any damage on the delivery note and notify the carrier and manufacturer.
2. 

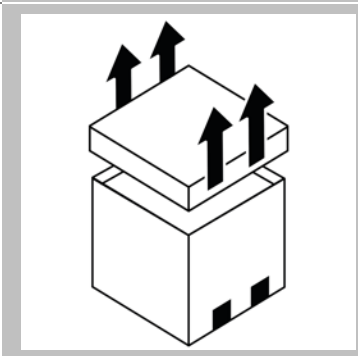
Cut the box banding straps.
3. 

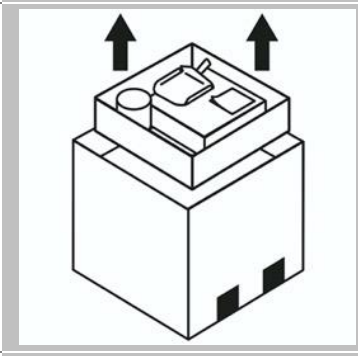
Remove the lid.
4. 

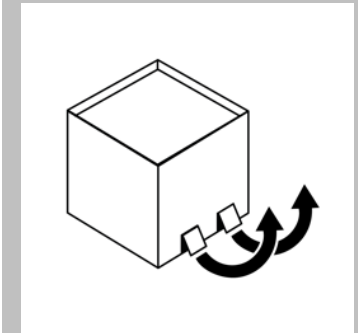
Remove the important document folder and product accessories. Take note of unpacking instructions.
5. 

Pull out cardboard flaps.

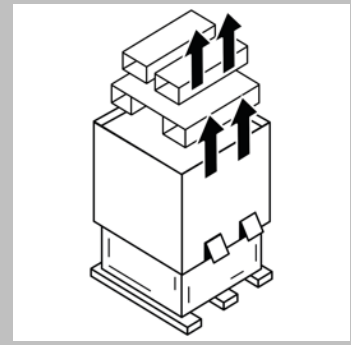
6.  Remove internal packing and outer sleeve.

7.  Remove plastic packaging.

8.  Release plug from carton holder.

⚠ WARNING

Never install or put into service a damaged appliance under any circumstances.

5.4 Taking the appliance off the pallet

The weight of your appliance is given in the 'Technical Data' section 11.0.

1.

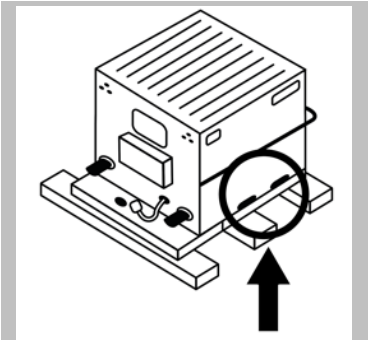

Identify appropriate lifting points.

2.

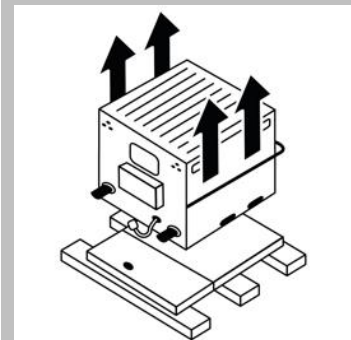

After pushing back the base cardboard at the front of the oven, lift the appliance from the packaging. (Ensure 2 people to lift)
Wear appropriate Personal Protective Equipment.

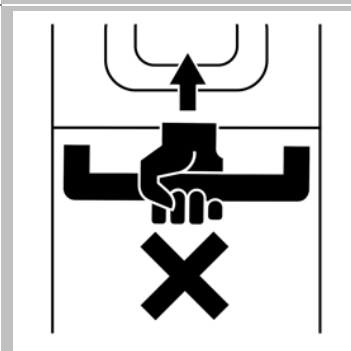
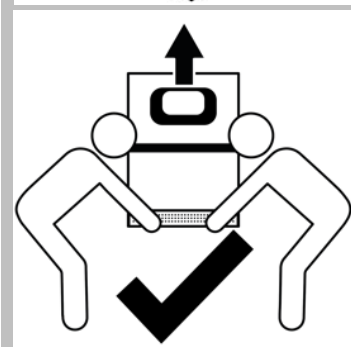

! WARNING

- Don't lift the oven from the handle.
- Risk of crushing from the appliance tipping over.

5.5 Mounting the appliance on a work surface

⚠ Rules for setting up the appliance

Observe the following rules to ensure that the appliance is installed in a stable situation:

- It must be possible to set up the work surface in the installation position so that it cannot tip over or slide about. The supporting surface must comply with the requirements.
- The work top must have a non-slip surface.

■ Merrychef conneX® base seal details:

According to Section 5.20.2 of NSF4;

Counter-mounted equipment shall be designed and manufactured to be:

- Portable; or
- Sealed to the counter; or
- Elevated on min. 4" legs that allow easy ingress for cleaning

The Merrychef conneX® oven is factory fitted with a self-sealing base-to-counter gasket that meets the requirements for NSF4 counter-mounted equipment.

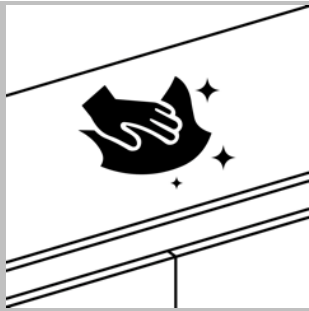
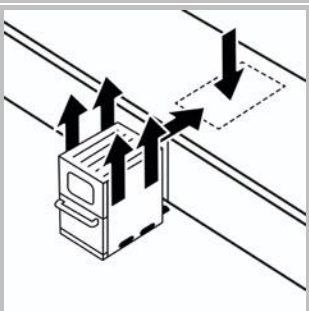
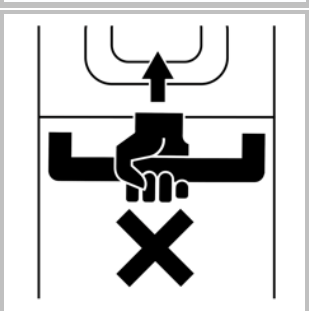
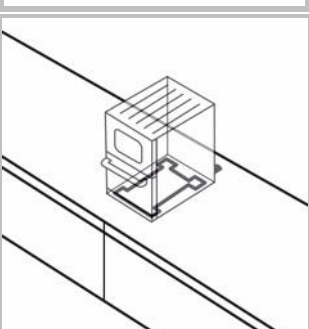
| | |
|---|--|
|  | <p>Prepare a flat and thoroughly CLEAN, dry surface for the oven.</p> |
|  | <p>Unpack the oven following the instructions in section 5.3 and lift the oven onto the prepared surface. (Ensure 2 people to lift).</p> |
|  | <p>⚠ WARNING</p> <ul style="list-style-type: none"> ▪ Don't lift the oven from the handle. ▪ Risk of crushing from the appliance tipping over. |
|  | <p>The base of the conneX is sealed to the counter with a rubber gasket affixed to the base of the oven in compliance with sealed counter mounted equipment directive of NSF4. The gasket is self-sealing to the installation surface, no further adhesive is necessary.</p> |

6 Installation

■ Purpose of this chapter

This chapter explains how to connect your microwave combination oven to the electrical supply.

6.1 Safe working during electrical installation

■ Eligibility of personnel for the electrical installation

Only electricians qualified under the terms of EN 50110-1 and from an authorized service company are permitted to perform work on electrical equipment.

■ Regulations for the electrical installation

Observe the following requirement to prevent hazards caused by faulty electrical connections:

- The electrical supply must be connected in accordance with applicable local and national regulations and regulations of the professional associations and of the relevant power supply company.

■ Personal Protective equipment

Wear the personal protective equipment specified in the section '*Personal protective equipment*' section 3.7 of the '*For your safety*' chapter for the relevant tasks.

■ Live components

DANGER

Risk of electric shock from live parts

When the appliance is not connected to an equipotential bonding system, there is a risk of electric shock from touching live parts.

- ▶ Make sure that any work on the electrical system is performed solely by a qualified electrician from an authorized service company.
- ▶ Make sure that the electrical connections are intact and connected securely before putting the appliance into use.
- ▶ Before preparing the appliance for use, make sure that the appliance, including all metallic accessories, is connected to an equipotential bonding system.

6.2 Planning the electrical installation

■ Meaning

It is crucial to the safe and reliable operation of the appliance that the electrical system is installed carefully and correctly. All the rules and regulations listed here, and the described procedure, must be strictly followed.

■ ⚠ Rules for safe electrical installation of the appliances

Observe the following rules to prevent hazards caused by faulty electrical connections:

- The electrical supply must be connected in accordance with applicable local regulations of the professional associations and of the relevant power supply company.
- The case of the appliance must be grounded in a suitable manner and connected to an equipotential bonding system (EU).
- If two microwave combination ovens are installed in a stacking trolley, both cases of the appliances and the trolley itself must be grounded in a suitable manner and connected to an equipotential bonding system.
- For microwave combination ovens on a wheeled platform, the length of the mains power lead must accommodate the degree of movement allowed to the appliance by the retaining device on the wheeled platform. When moving the assembly (platform plus appliance), never place the mains power lead under tension.
- All electrical connections must be checked when the appliance is prepared for first-time use to ensure cables are laid correctly and connections are made properly.

■ Equipment provided by customer and electrical installation regulations

The table below shows what equipment must be provided by the customer and what regulations must be observed when connecting the appliance.

| Equipment | Regulations |
|---|---|
| MCB / Fuse | Overcurrent protection and connection of the appliance must comply with local regulations and national installation requirements. If the installation includes more than one appliance, one overcurrent device must be provided for each appliance. |
| Equipotential bonding | The appliance must be incorporated in an equipotential bonding system (EU). Equipotential bonding: electrical connection that ensures that the frames of electrical equipment and any external conductive components are at an equal (or practically equal) potential. |
| Residual-current device (RCD) / Ground Fault Circuit Interrupter (GFCI) | The installation regulations require protection by a residual-current device (RCD). Suitable residual-current devices meeting the relevant national regulations must be used. If the installation includes more than one appliance, one residual-current device must be provided for each appliance. |
| Disconnection device | An easily accessible all-pole disconnection device with a minimum contact separation of 3 mm must be installed close to the appliance. The appliance must be connected via this disconnection device. The disconnection device is used to disconnect the appliance from the electrical supply for cleaning, repair, and installation work. |

■ Fitted frequency-converter

The appliance is fitted with one frequency converter (FC) and EMC mains input filters.

These devices may result in a leakage current of more than 3.5 mA per FC drive.

Use a suitable RCD for the rated voltage.

■ Properties of the residual-current device

The residual-current device (RCD) must have the following properties:

- Filter for filtering out RF currents
- "Time delayed" trip characteristic for RCD devices with trip threshold of 30mA*: prevents RCD being tripped by charging currents of capacitors and parasitic capacitances when appliance is switched on.
- "Leakage current protection, type SI" trip characteristic for RCD devices with trip threshold of 30mA*: insensitive to nuisance tripping.
- *Local national regulations may require lower trip ratings, such as in North America. In which case these lower trip threshold ratings must be adopted, ensuring the dedicated device has a high immunity to nuisance tripping.

Note. Residual Current Devices (RCDs) are also known by other terms, such as Earth Leakage Circuit Breakers (ELCBs), Safety Switches, Ground Fault Interrupters (GFIs) and Ground Fault Circuit Interrupters (GFCIs). These should not be confused with overcurrent protection.

6.3 Electrical installation requirements

Circuit Breakers (MCB ~ Miniature Circuit Breakers)

For overcurrent protection, a Type 'D' circuit breaker (designed specifically for this type of equipment) must be fitted, as a recommend alternative a higher rated type 'C' type breaker can be used (see below). Establishments with standard (Type 'B') circuit breakers are sensitive to 'surges' which occur on switching on freezers, refrigerators and other catering equipment, including microwave combination ovens. An individual, suitably rated overcurrent circuit breaker should be fitted for each appliance installed, along with a separate dedicated Residual Current Device (Ground Fault Circuit Interrupter).

| Model | Recommended Circuit Breaker (per phase) | Alternative Recommended Circuit Breaker (per phase) |
|--|---|---|
| ConneX 12 standard power | D16 | C20 |
| ConneX 12 high power/conneX 16 - 1 phase | D32 | C40 |
| ConneX 12 high power/conneX 16 - 3 phase | D16 | C20 |

Residual-current device (RCD)

The installation regulations require protection by a Residual Current Device (Ground Fault Circuit Interrupter). Suitable residual current devices, with a high immunity to nuisance tripping, meeting the relevant national regulations must be used. As long cable runs can be a factor in nuisance tripping, they should be avoided.

If the installation includes more than one appliance, one residual-current (GFCI) device must be provided for each appliance.

Low impedance electrical supply

This commercial combination microwave oven complies with EN 61000-3-11. However, when connecting sensitive equipment to the same supply as the appliance, the user should determine in consultation with the supply authority, if necessary, that a low impedance supply is used.

Electrical supply

| Illustration | Phase | Meaning |
|--|-------------------------------------|---|
| | Single phase | <p>UK 13A models are fitted with a moulded plug to BS1363, fused at 13A.</p> <p>EU 16A models are fitted with a moulded plug to CEE 7/7 (Type F Schuko) rated at 16A</p> <p>30A models are fitted with a blue 32A plug to IEC 60309 (EN 60309).</p> <p>Connected to a dedicated RCD (GFCI) protected supply, with appropriate circuit breaker as detailed above.</p> |
| | Twin phase | <p>Twin phase models should be connected as shown (the twin phase oven requires a three phase supply, utilising L1 & L2 as two separate single phases, L3 is not used).</p> <p>30A models are fitted with a red 32A plug to IEC 60309 (EN 60309).</p> <p>EU 16A models are fitted with a red 16A 90° plug to IEC 60309 (EN 60309).</p> <p>Connected to a dedicated RCD (GFCI) protected supply, with appropriate circuit breaker as detailed above.</p> |
| | Single phase 60Hz (two pole) | <p>Single phase models, utilising L1 & L2 split phase supply (240V) or L1 & L2 from a three phase supply (208V). Neutral is not used.</p> <p>15A models are fitted with HBL5666C NEMA 6-15P & 15A HBL4570C NEMA L6-15P plugs.</p> <p>20A models are fitted with a HBL5466C NEMA 6-20P plug.</p> <p>30A models are fitted with YP-91L NEMA 6-30P & HBL2621 NEMA L6-30P plugs.</p> <p>Connected to a dedicated RCD (GFCI) protected supply, with appropriate circuit breaker as detailed above.</p> |
| Please refer to electrical installation data for other country specific models. | | |

Equipotential bonding



An Equipotential Bonding point is provided on the rear panel of the appliance for independent Earth (GND) connection (not fitted to US models).

Example phase loading diagram

Loading per phase is not equal. Therefore, it is recommended to connect other electrical equipment to a separate L3+N from the mains supply.

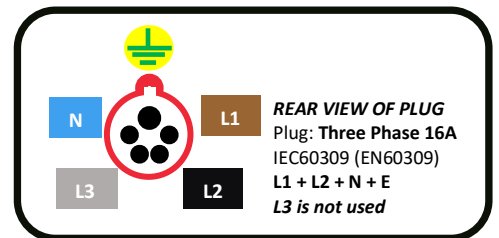
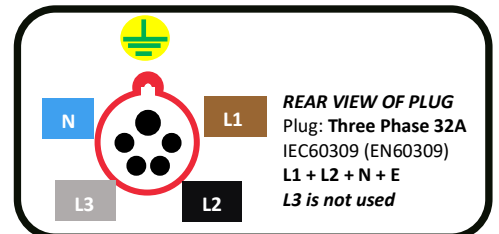
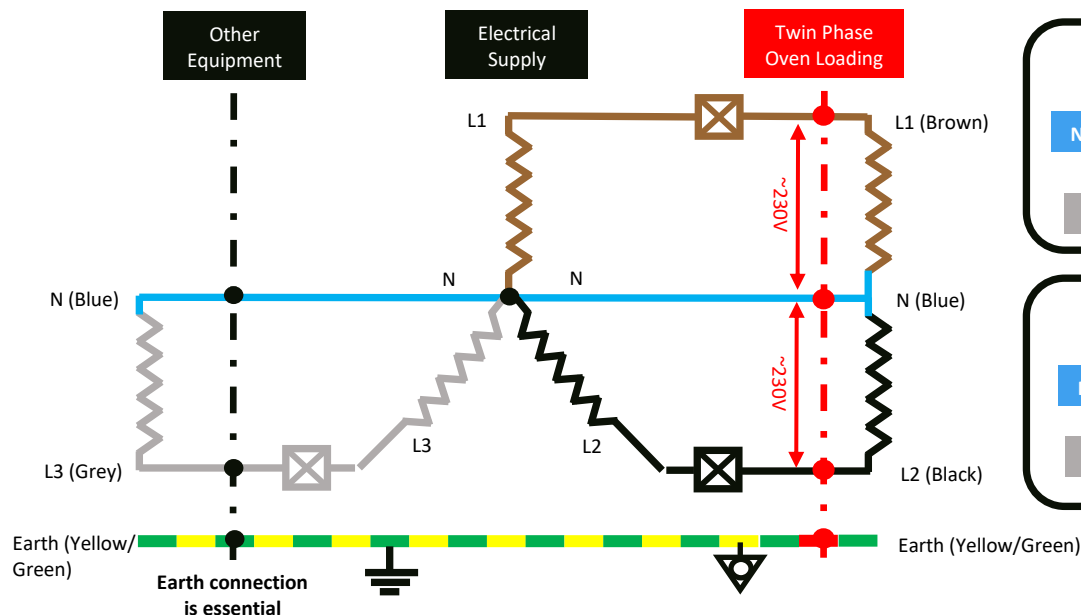
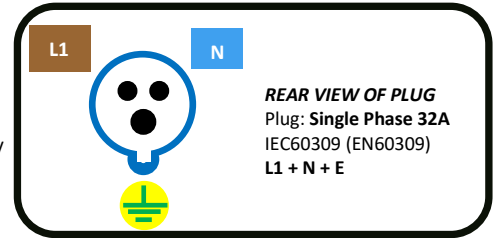
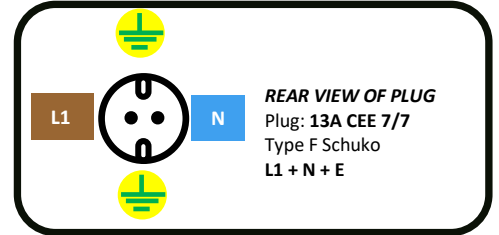
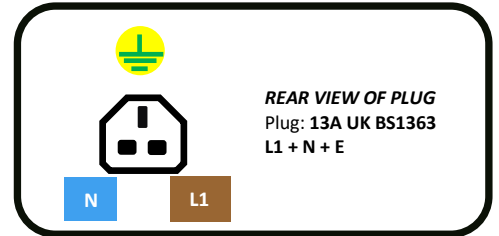
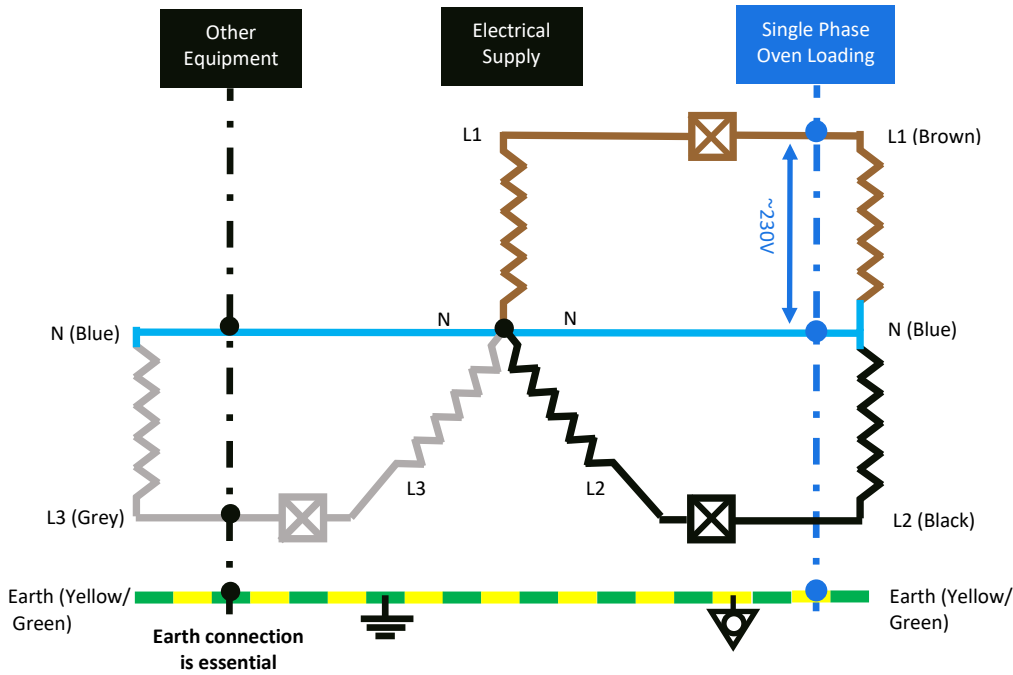

■ US and Canada

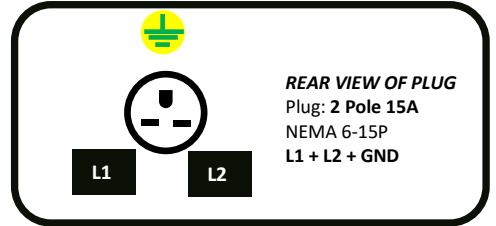
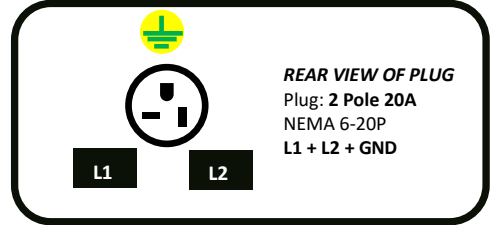
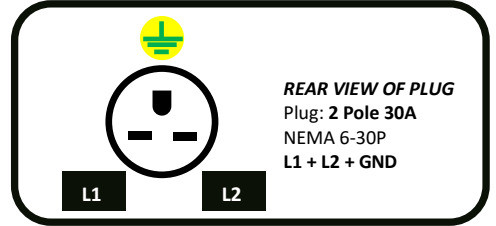
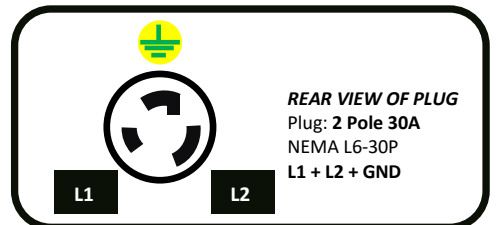
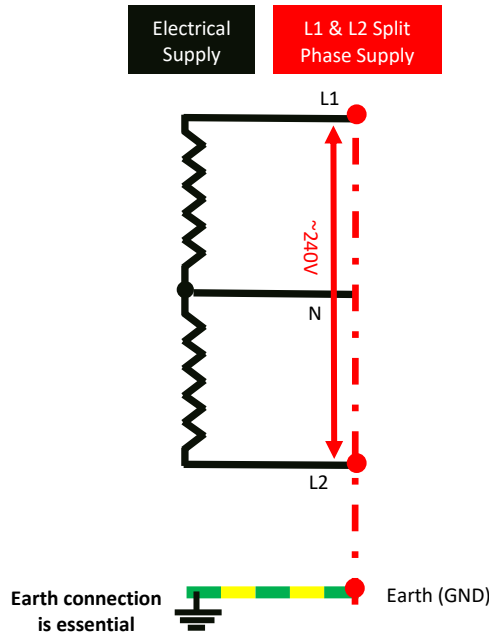
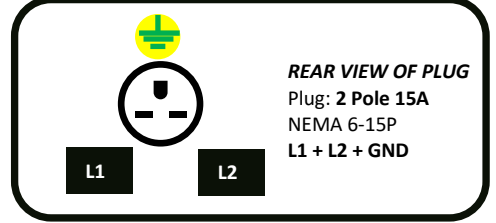
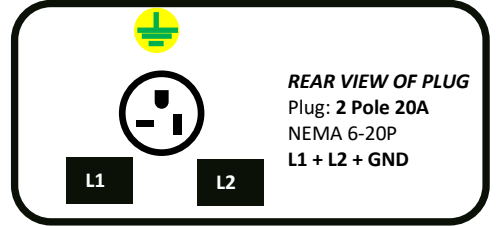
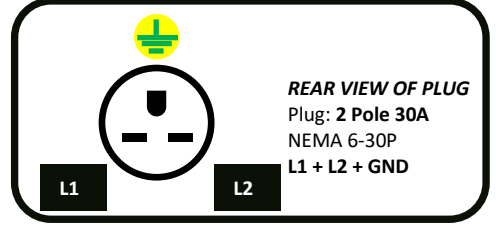
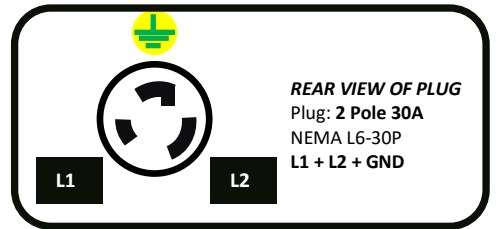
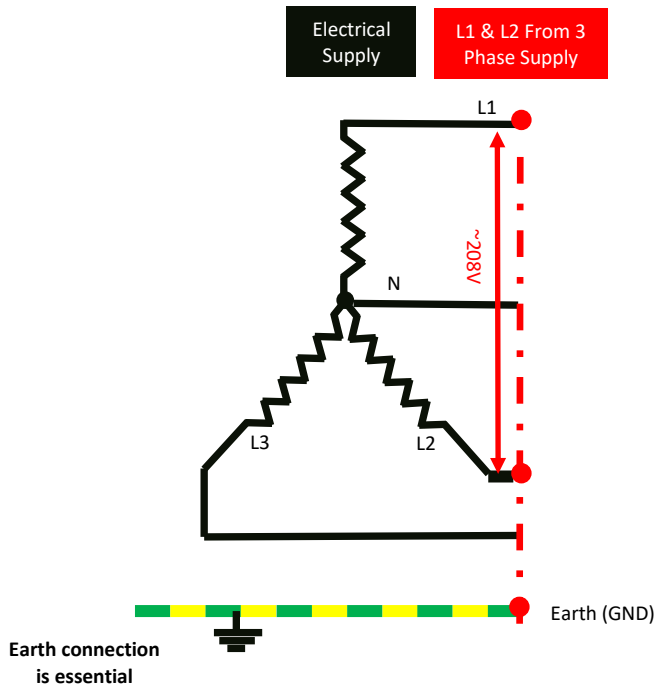

7 Preparing the appliance for use

■ Purpose of this chapter

To show you how to put the microwave combination oven into operation and how to cook.

7.1 Safe working when preparing the appliance for use

■ Personal protective equipment for preparing the appliance for use

Wear the personal protective equipment specified in the section '*Personal protective equipment*' section 3.7 of the '*For your safety*' chapter for the relevant tasks.

■ Rules for safe operation of the appliance

To avoid hazards, the following rules must be observed during operation:

- The exhaust vent on the rear of the appliance, and the ventilation holes in the front of the appliance base must not be covered, obstructed or blocked.
- Ensure all appropriate accessories are fitted.

To avoid hazards, the following rules must be observed when operating appliances positioned on a wheeled supporting structure:

- The parking brakes on the front wheels must always be engaged when operating the appliances.
- Check that the wheel brakes are on before operation each day.

■ Live components

DANGER

Risk of electric shock from live parts

When the appliance is not connected to an equipotential bonding system, there is a risk of electric shock from touching live parts.

- ▶ Make sure that any work on the electrical system is performed solely by a qualified electrician from an authorized service company.
- ▶ Before preparing the appliance for use, make sure that the appliance, including all metallic accessories, is connected to an equipotential bonding system.

■ Hot surfaces

WARNING

Risk of burns from high temperatures inside the cavity and on the inside of the appliance door

- ▶ You may get burnt if you touch any of the interior parts of the cooking chamber, the inside of the appliance door or any parts that were inside the oven during cooking.
- ▶ Wear personal protective equipment.

■ Hot steam / vapour

WARNING

Risk of scalding from hot steam and vapour

- ▶ When opening the door, always be cautious of escaping hot steam and vapour which can cause scalding to face, hands, feet and legs.
- ▶ When you are cooling the cavity using the 'cool down' function, step back from the appliance to avoid the hot steam and vapour escaping through the open door.

■ Excessive microwave energy

WARNING

Risk of burns from excessive microwave energy

PRECAUTIONS TO AVOID POSSIBLE EXPOSURE TO EXCESSIVE MICROWAVE ENERGY

- ▶ Do not attempt to operate this oven with the door open since open-door operation can result in harmful exposure to microwave energy. It is important not to defeat or tamper with the safety interlocks.
- ▶ Do not place any object between the oven front face and the appliance door or allow soil or cleaner residue to accumulate on sealing surfaces.
- ▶ Do not operate the oven if it is damaged. It is particularly important that the oven door closes properly and that there is no damage to the (1) door (bent), (2) hinges, (3) door seals and sealing surfaces.
- ▶ The oven should not be adjusted or repaired by anyone except properly qualified service personnel.

■ Radio interference

NOTICE

This is a Class A product. In a domestic environment this product may cause radio interference in which case the user may be required to take adequate measures.

Reduce or eliminate interference to radio, television, or other electrical appliances by doing the following:

- Place electrical appliances as far away from the microwave combination oven as possible.
- Use a properly installed antenna on radio, television, etc. to obtain stronger signal reception.

7.2 Procedure for preparing the appliance for use

■ Checks prior to preparing the appliance for use

Before preparing the microwave combination oven for use, use the checklists below to make sure that all important requirements are met. The appliance must not be put into operation until all the specified requirements are met.

Checklist for moving, setting up and installing the appliance:

- Cardboard packaging and transport securing devices etc. have been removed completely from the appliance.
- The appliance has no signs of damage.
- The appliance has been set up so that it cannot slide about or tip over; the requirements for the installation position and the area around the appliance have been met.
- The appliance is installed in accordance with the installation regulations.

Checklist for safety devices and warnings:

- All safety devices are in their designated position, are working correctly and are secured properly in place.
- All warning signs are in their designated position.

■ Suitable cooking utensils

Check the manufacturer's instructions and temperature rating to determine the suitability of individual containers or utensils using each of the cooking functions. The following chart provides general guidelines:

| Cooking utensils | Permitted | Notice |
|--|-----------|--|
| Heat resistant containers | | |
| Toughened glass | YES | |
| Compatible vitreous ceramics | YES | Do not use items with metallic decoration. |
| Earthenware (porcelain, crockery, china, etc.) | YES | |
| Metallic and foil trays | | |
| Any metal or foil containers | NO | |
| Plastic containers | | |
| Dual-oven able plastic containers | YES | Use only plastic containers approved by the manufacturer. |
| Disposables | | |
| Combustibles (paper, card, etc.) | YES | Use only combustibles approved by the manufacturer. |
| Other utensils | | |
| Tie tags | NO | |
| Cutlery | NO | No kitchen utensil should be left in a food product while it is cooking in the cavity. |
| Temperature probes | NO | |

■ Start up

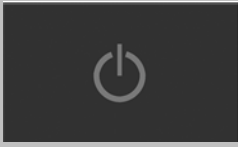
- 

Make all the relevant safety checks and ensure the appliance is clean and empty, and plugged in. Then switch the appliance ON by selecting the power icon on screen.
- 

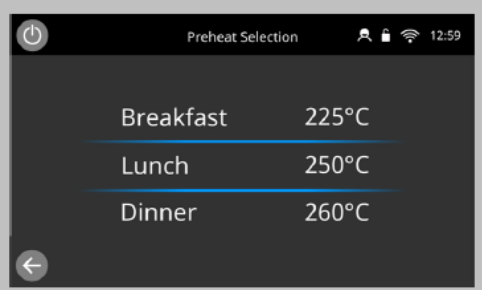
The easyTouch® screen illuminates with a display scrolling through the Welbilt brands. Once booted the Merrychef splash screen appears, giving the options of "information" or "settings" shortcuts. If left idle the screen automatically progresses to Preheat/Preheat selection. If only one preheat temperature has been pre-set, the oven will then automatically start heating up to temperature.
- 

When the appliance is set up with two or more preheating temperatures a choice is displayed. A scroll bar at the side of the screen indicates that there are more temperature choices not shown on the screen. If necessary, swipe up or down to navigate the preheat selections available. Then select the temperature required to start preheating the cavity.

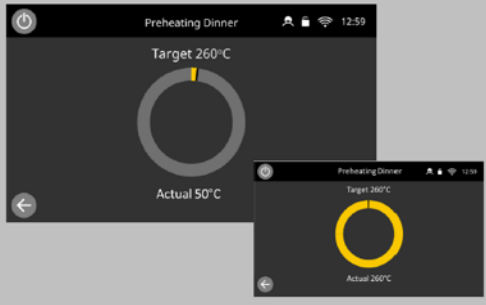
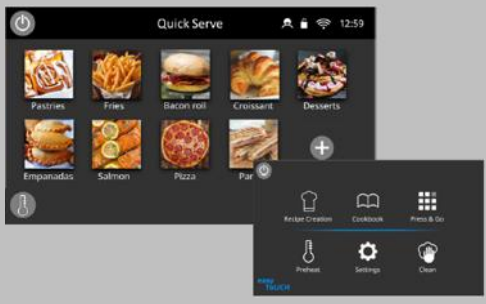
4.  During preheating the display shows the progress as the cavity heats up to the set temperature.
To stop the cavity heating up touch the back arrow in the bottom left of the screen. (This will return you to the previous screen).
5.  In Quick Service Mode the appliance is ready to use when the 'cookbook' is displayed.
In Full Serve Mode the 'Home' screen ("chefs' hat screen") is displayed.

Customer guidance and instruction

Instruct the user regarding all safety-related functions and devices.





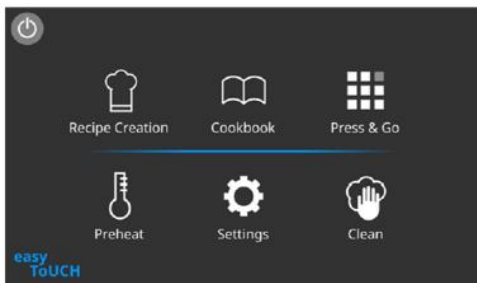

Instruct the user in how to operate the appliance.

7.3 Main menu screen

Appearance



The buttons and what they do

| Button | Meaning | Function |
|---|----------------------------------|--|
|  | Recipe creation/Development Mode | 'Recipe creation' enables multistage cooking profiles to be developed, then stored under a name and icon for reuse. |
|  | Press & Go | 'Press & Go' allows quick access to use the cooking profiles that are already stored. |
|  | Cookbook | 'Cookbook' contains the cooking profiles stored in the memory of the appliance. It displays favourites, cooking profile groups and a complete listing of all cooking profiles available. |
|  | Cleaning | 'Cleaning' allows the appliance to be prepared for cleaning with pictorial displayed assistance during the cleaning process. |
|  | Temperature Change | Preheats are used to control the appliance operating temperature, up to 6 preheats can be stored for the appliance. |
|  | Settings | 'Settings' are used to control the appliance settings and functions including time and language, loading cooking profiles and for service and maintenance purposes. |

■ The easyTouch® screen display







The easyTouch® screen display, layout and icons shown herein are for guidance purposes only and are not intended to be an exact representation of those supplied with the appliance.

7.4 The keyboard screen

■ Appearance



■ The buttons and their functions

| Button | Meaning | Function |
|---|-----------------|--|
|  | Keyboard screen | The keyboard screen is used to enter an authorised password to enter data for programmes and may restrict operator access to some functions. |
|  | Clear screen | Select the 'clear screen' key to delete all text from the keyboard screen. |
|  | Keyboard | Type in text using the keyboard. |
|  | Keyboard scroll | Select the up/down arrows to scroll the keyboard screen, for lowercase, numbers, etc. |
|  | Enter / OK | Select the green tick to confirm settings and continue. |
|  | Previous screen | Select the 'backspace' key to return to a previous screen. |

■ Character length

- For names of cooking profiles, names of categories and passwords use 1-20 characters in 2 lines max.
- For stage instructions of individual cooking profiles use 1-54 characters in 5 lines max.

8 Cooking procedures

Purpose of this chapter

This chapter shows you how to operate the microwave combination oven for cooking and what procedures to follow for cooking.

8.1 Operating principles and instructions for cooking

8.1.1 Working safely with the appliance

Your safety and the safety of your staff

Before your personnel start working with the microwave combination oven for the first time, familiarize yourself with the information contained in the chapter '*For your safety*' section 3, and make relevant safety arrangements.

Instruct your personnel to learn the safe-working rules given in this section before starting work, and to follow them strictly.

Instruct your personnel to familiarize themselves with the hazard warnings listed in this section and in further instructions below and instil in them the importance of taking the specified precautions.

Personal protective equipment for your personnel

Instruct your personnel to wear the correct personal protective equipment specified in the section '*Personal protective equipment*' section 3.7 of the '*For your safety*' chapter for the relevant tasks.

Rules for safe operation

To avoid hazards, the following rules must be observed during operation:

- The air outlets on the rear of the appliance, and the air inlets on the front of the appliance underneath the door must not be covered, obstructed or blocked.

Additional rules for safe operation on a wheeled trolley

To avoid hazards, the following rules must be observed when operating appliances positioned on a wheeled trolley:

- The parking brakes on the front wheels must always be engaged when operating the appliances.
- Check that the wheel brakes are on before operation each day.

Handling heavy loads

Inform your personnel that lifting heavy containers and moving heavy transport trolleys may result in tiredness and discomfort, and faults may occur with the moving equipment.

Hot surfaces

WARNING

Risk of burns from high temperatures inside the cavity and on the inside of the appliance door

You may get burnt if you touch any of the interior parts of the cavity, the inside of the appliance door or any parts that are or were inside the oven during cooking. Wear personal protective equipment.

■ Hot steam / vapour

WARNING

Risk of scalding from hot steam and vapour

Escaping hot steam and vapour can cause scalding to face and hands.

- ▶ When opening the door and when cooling the cavity using the 'Cool Down' function, step back from the appliance to avoid the hot steam and vapour hitting your body after escaping through the open door.

■ Hot liquids

WARNING

Risk of scalding from hot liquids

Spilling liquid foods can result in scalds to face and hands.

- ▶ Only use containers of appropriate size.
- ▶ Insert the food containers correctly.
- ▶ Always place containers holding liquids or holding food that will liquefy during cooking on shelves that allow a proper view into the container for all users. Always take out horizontally any containers holding liquids or holding food that will liquefy during cooking.
- ▶ Wear personal protective equipment.

■ Excessive microwave energy

WARNING

Risk of burns from excessive microwave energy

PRECAUTIONS TO AVOID POSSIBLE EXPOSURE TO EXCESSIVE MICROWAVE ENERGY

- ▶ Do not attempt to operate this oven with the door open since open-door operation can result in harmful exposure to microwave energy. It is important not to defeat or tamper with the safety interlocks.
- ▶ Do not place any object between the oven front face and the appliance door or allow soil or cleaner residue to accumulate on sealing surfaces.
- ▶ Do not operate the oven if it is damaged. It is particularly important that the oven door closes properly and that there is no damage to the (1) door (bent), (2) hinges, (3) door seals and sealing surfaces.
- ▶ The oven should not be adjusted or repaired by anyone except properly qualified service personnel.

■ Break in the cold chain

WARNING

Risk of microbiological contamination of foods

- ▶ Never use the appliance for temporary storage of food.
- ▶ Never intentionally interrupt the cooking process.
- ▶ Once the appliance is running again after a power failure, consider how the length of time taken to resume operation will affect the food condition. If in doubt discard the food.

8.1.2 Turning the oven on and off



■ For your safety when using the microwave combination oven

Before starting work, it is essential that you familiarize yourself with the rules and hazard warnings specified in '*Working safely with the appliance*' section 8, and follow the instructions given there.

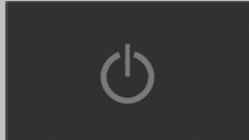
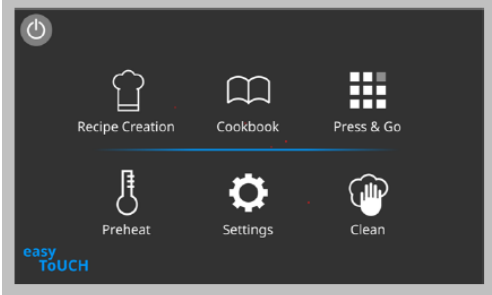
■ Switching on the microwave combination oven

- | | | |
|----|---|---|
| 1. |  | Switch on the microwave combination oven. |
| 2. |  | <p>Wait until the software is ready for use.</p> <p>NOTE: The 'Home' screen visible on the left is only displayed in Full Serve Mode.</p> |

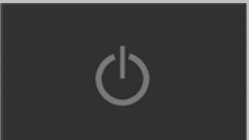
■ Switching off the microwave combination oven at the end of the day

- | | | |
|----|---|--|
| 1. |  | Perform the necessary cleaning tasks as specified in the cleaning schedule. |
| 2. |  | Switch off the microwave combination oven. |
| 3. |  | <p>Leave the appliance door ajar to let moisture escape.</p> <p>NOTE: Switch off the mains power on site before prolonged breaks in use.</p> |

8.1.3 How to cook

-  For your safety when using the microwave combination oven
Before starting work, it is essential that you familiarize yourself with the rules and hazard warnings specified in 'Working safely with the appliance' section 8, and follow the instructions given there.

■ Requirements

- You are sufficiently familiar with using the software to be able to select saved cooking profiles or enter new cooking profiles that are suitable for the food you wish to cook, and to run these profiles.
- The microwave combination oven and accessories and fittings used have been cleaned properly.
- There are no foreign objects in the cavity.
- The air filter is fitted in place on the oven front underneath the appliance door.

How to cook

1. Select a cooking profile from the cookbook or enter a new cooking profile.
2. Follow the prompts displayed by the software.
3. Open the appliance door.
4. Place the prepared food in the microwave combination oven.
5. Close the appliance door again.
6. Start the cooking process.
7. Wait for the cooking process to finish.
8. An audible signal is given when the cooking process is finished. Follow the prompts displayed by the software.
9. Open the appliance door.
10. Take out the food.
11. Close the appliance door again.

Using a cooking profile (Quick serve Mode)

1.

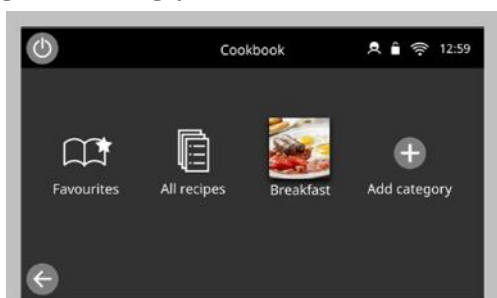

Select the 'All recipes' icon.

2.

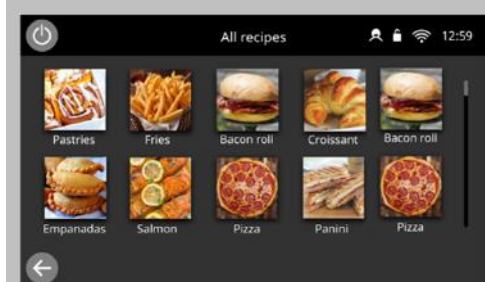

Swipe up/down to find the recipe.

NOTE:

If a picture is greyed out the cavity temperature is set too high or too low for that cooking profile.

See '*Changing the cavity temperature*' section 8.2.4.

Ensure that a food product is placed into the cavity before starting a cooking profile.

Take all the necessary precautions to ensure that you do not burn yourself.

Open the appliance door, place the food product into the hot cavity and close the door.

3.

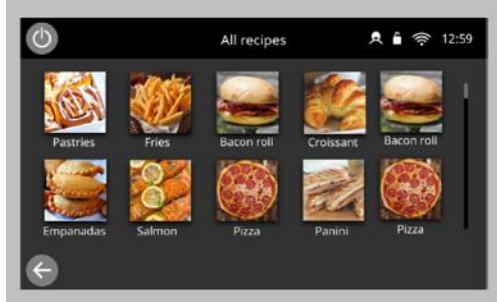



Select the required recipe to start cooking.

Example: '*Bacon Roll*'.

⚠ WARNING:

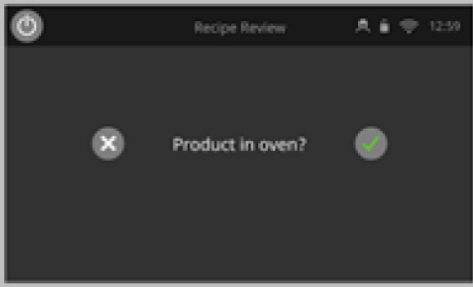

Hot surfaces at the door and in the cavity

4.  The cooking profile either starts immediately displaying a countdown timer, or an instruction is displayed first. Follow the stage instruction and then press the green tick button to start the cooking profile.
5.  The cooking timer counts down to zero and makes a sound to indicate that an operator action is required at the end of a cooking profile or of a stage of a cooking profile. Open the door after the cooking profile has finished and remove the food product from the cavity. The display then returns to the 'cookbook' screen automatically.
- NOTE:**
- Opening the door during cooking stops the cooking profile and a warning appears.
 - Closing the door allows the user to continue or cancel the cooking profile.





8.2 Operation instruction: Full serve mode

8.2.1 The Press & Go menu

Running a cooking profile from the Press & Go menu

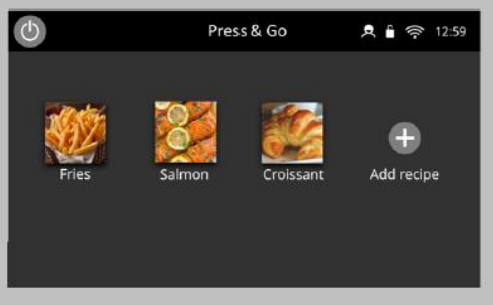
1.  Select 'Press & Go' from the main menu screen.
2.  Select the cooking profile required to cook.
3.  The display shows the cooking time count down.

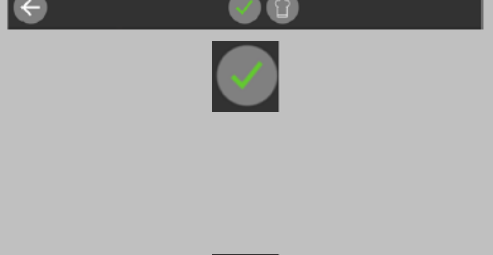

■ Choosing which cooking profiles are shown in the Press & Go menu screen

1.  After selecting 'Press & Go' from the main menu screen, select the 'plus' button.
(Note: this will only be available if the system is unlocked)
2.  Recipes list view is displayed which contains all saved recipes on the appliance.
All 'Green ticked' recipes are already being displayed in your 'Press & Go' cookbook, to remove untick, or to add a recipe tick, against the recipe name.
Narrow down the list using the search bar at the top of the screen.
3.  By selecting the green tick you will add or remove recipes from your Press & Go view.
In order to reorder items on screen follow the move, edit or delete sequence shown in section 8.2.4.
4.  If you want to add a recipe that is not already saved select the 'chef's hat' button to allow the creation and saving of a new recipe, shown in 8.2.3.
5.  Select back arrow to return to the 'Press & Go' menu without saving.

8.2.2 Using a cooking profile

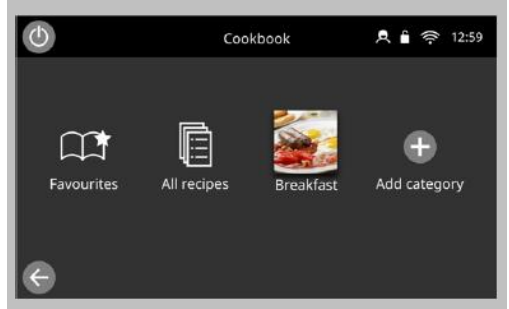
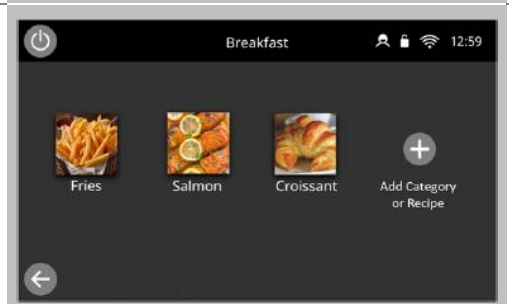
■ Using a cooking profile

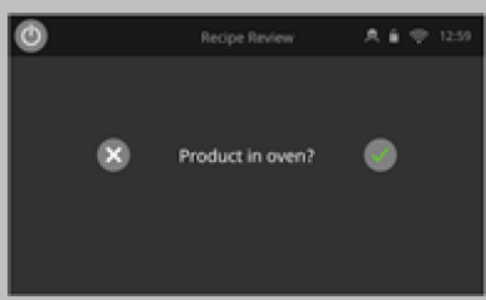
1.  Select the 'cookbook' icon from the 'Home' screen.
2.  Select a menu category, for example 'Breakfast', to display the individual recipe profiles or sub-folders.
3.  Select a cooking profile to start, for example 'Croissant'.

4.  Follow any instructions on the screen, if displayed.
Press the green tick button to cook.
5.  The cooking time counts down for each program stage.

To check the cavity temperature when cooking, lightly tap the temperature displayed. The cavity temperature is shown with an asterisk.
6.  When the cooking profile ends you will be taken automatically to a 'cooking finished' screen and an audible sound will play.
Opening the appliance door during cooking stops the cooking profile and displays a warning.
Closing the door allows the user to continue or cancel the cooking profile.

8.2.3 Creating a cooking profile

Recipe Creation

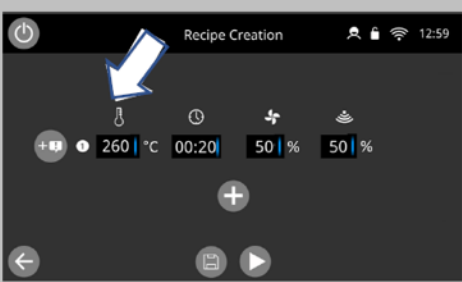
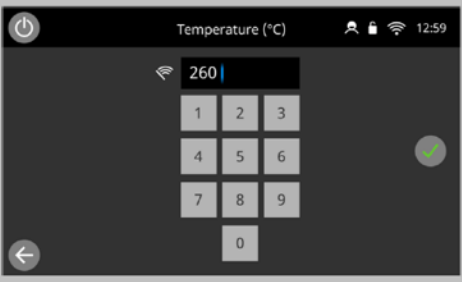
1.  Select the 'chef's hat' icon from the 'Home' screen to enter the Recipe Creation Mode.
2.  The temperature value displays the set temperature for preheating the cavity.
To increase or decrease the temperature required, select the box under the 'temperature' icon.
-  Enter a temperature value in the keypad within the limits (100-275 °C / 212 °F – 527 °F) displayed.

Select the green tick to continue.

3. To input the cook time, select the box under the 'clock' icon.

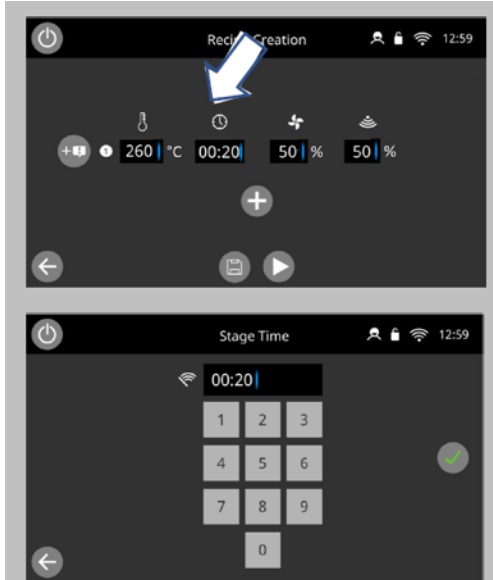

Enter the cooking time in the keypad up to a maximum of 10 minutes for each stage.

Example: Enter 110 (for 1 minute and 10 seconds).

Select the green tick to save the inserted value.

4. To input the 'fan' speed select the box under the 'fan' icon.

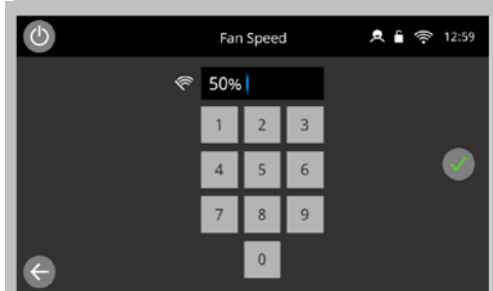

Set the fan speed in the keypad (10-100%)

Select the green tick to save the inserted value.

5. To input the 'microwave' power select the box under the 'microwave' icon.

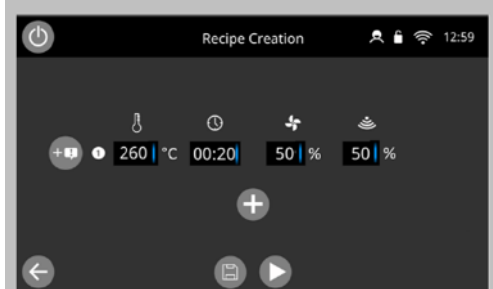

Set the microwave power in the keypad (0 and 5-100%).

Select the green tick to save the inserted value.

6. Select the '+ Note' button to enter an instruction of a stage line (optional).

Example: "Use the green basket".

When cooking the instruction appears in the display at the beginning of that stage.

Select this instruction line to enter a stage instruction. this can be a text only, image only or text and image prompt.

Select the 'plus' button at the bottom to add a new stage.

Delete a stage by pressing the 'trash' button next to that stage.

Cooking profiles can have up to a maximum of 6 stages.

Repeat the steps 2-6 from stage 1 above to create a new stage.

Scroll up and down to view the stages of the cook profile.

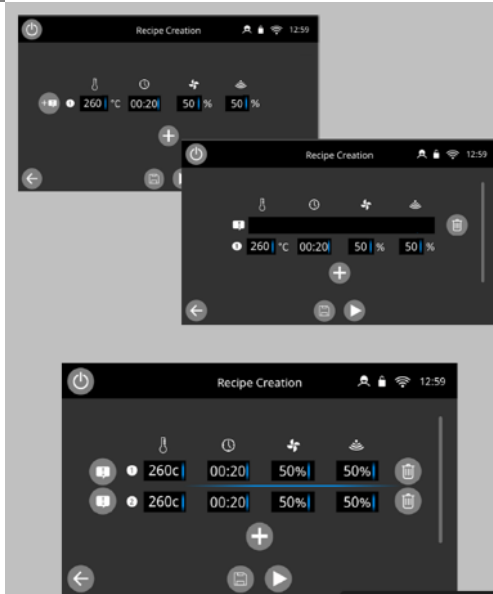

■ Running and saving a cooking profile

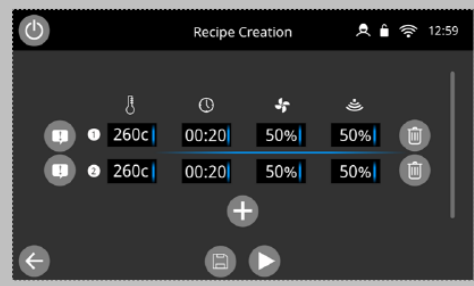
1.  Press the 'play' button to test the recipe program created.

⚠ WARNING:

Ensure that a food product is in the cavity and that all safety precautions are followed before running the cooking profile.

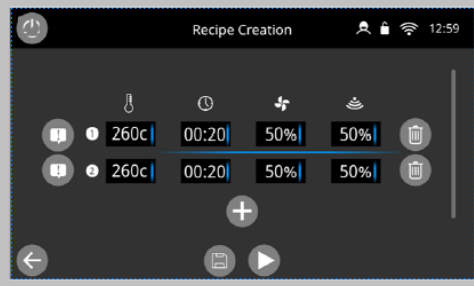
2.  Select the 'save' symbol to record the cooking profile to the cookbook.

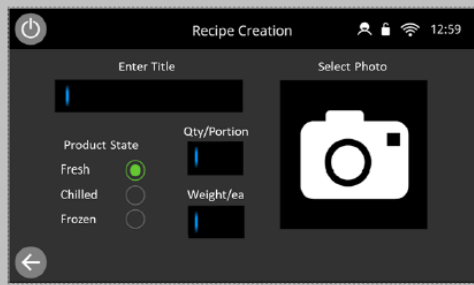
3.  Complete the 'recipe card' details including the recipe title, product state, quantity/portion size, and weight/each designation for the recipe, and select a photo.

4.  Quantity and portion and weight are defaulted but should be changed specifically to the product.

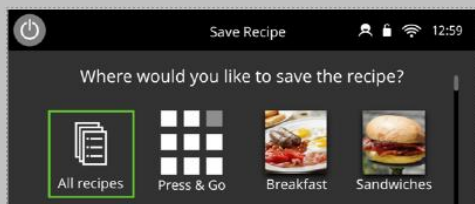
5.  Selecting the 'save' icon will take you to areas within the current cookbook structure where you can save the recipe file. 'All recipe' is always selected, but you can also select Press & Go or existing cookbook categories currently on the oven. By confirming with the green tick, the recipe file is saved to the specified locations.

8.2.4 Changing a cooking profile

Changing the cavity temperature

- 

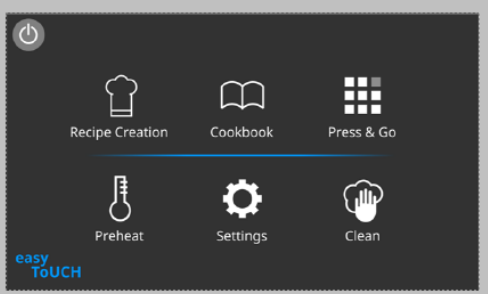
Recipes not created for the ovens current preheat temperature will be inactive and greyed out, to determine these recipes preheat temperature select, press and hold the icon until the edit/delete option appears over the button, then select edit to investigate the recipes parameters. Then return to the 'Home' screen.
Note: this can only be done when the operating mode is unlocked in 'Modes'.
- 

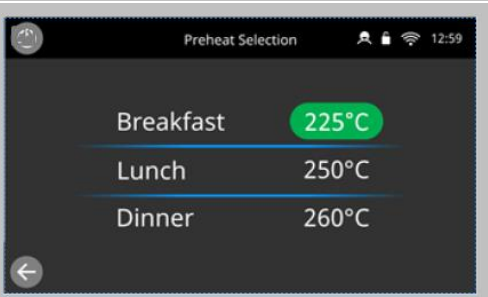
Select the 'Preheat' icon on the 'Home' screen, or the preheat button in the bottom left hand corner of the screen if the oven is in Quick Serve or Press & Go modes.
Note: the preheat icon does not appear in the latter two modes if only one preheat has been set on the appliance.
- 

A green highlight of the temperature value indicates the present cavity temperature.
Select the required cavity temperature for the cooking profile, for example 250°C / 482°F.
Once the cavity reaches the required temperature continue from selecting the 'cookbook' in step 1.

Viewing and editing cooking profiles

- 

Select the 'cookbook' icon from the 'Home' screen.
- 

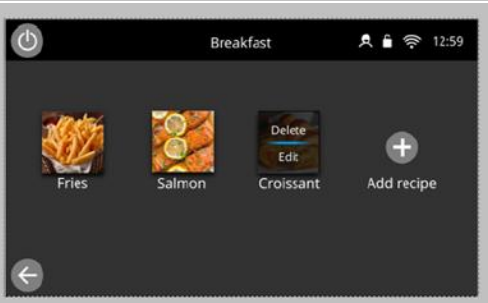
Select the 'All recipes' icon.
- 

Select and hold on an image to access the edit and delete functions.
Note: This is only available when the operating mode is unlocked in 'Modes'.

4. Selecting the edit function takes the user to that recipe files parameters in recipe creation which can be altered, tested and/or saved. Selecting delete will delete the recipe profile from the oven, Note: That only deleting from the 'All recipes' folder will delete entirely from the appliance, deleting from cookbook folders will only remove from that cook folder.

■ Move a recipe profile within a category or move a category within a group of categories

Example: Moving the position of the 'CROISSANT' recipe profile within the category of recipe profiles called 'BREAKFAST'

1. Select the 'Cookbook' icon from the main menu screen.
2. Select, for example, the 'Breakfast' category.
3. Select, for example, 'Croissant' and press and hold the image you wish to move, until the edit/delete overlay appears.
4. Drag the recipe to the desired location on the screen.
5. Then release to drop the recipe into that location.

■ Add a recipe into a category

Example: Add a cooking profile 'Croissant' to the category of 'Breakfast'

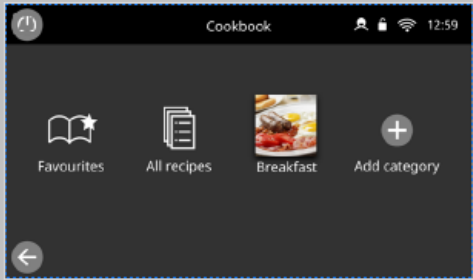
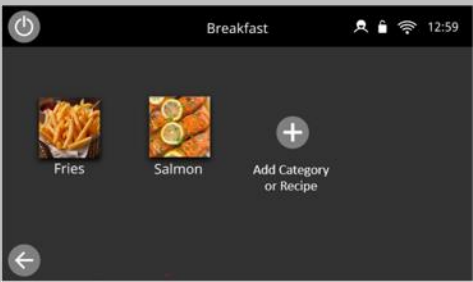
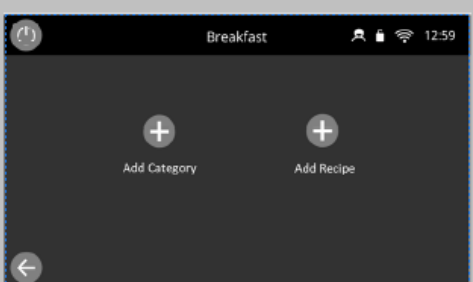
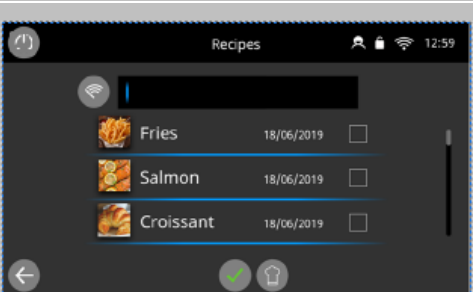
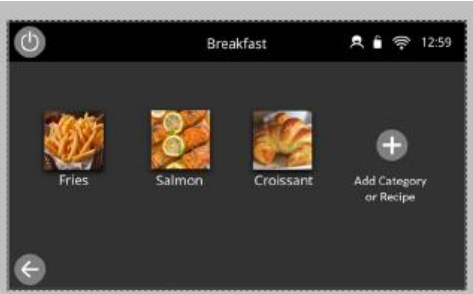
1.  Select 'cookbook' from the main menu screen.
2.  Select the group of recipe profiles 'BREAKFAST'.
3.  Select the 'ADD CATERGORY OR RECIPE' symbol.
4.  In the Breakfast category you have the option to add either a category or a recipe, to add a recipe select the 'ADD RECIPE' symbol.
5.  This opens up the all recipes folder, which includes all recipes saved on the oven. Check the recipe that you would like to include and select the green tick to confirm your selection(s).
6.  On selection of the green tick, the recipe files selected will be imported into your category.

8.2.5 Managing Categories of cooking profiles

Adding a Category folder

1.  Select 'cookbook' from the main menu screen.

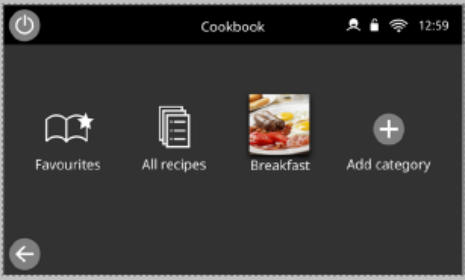
2.  Select the category, for example 'Breakfast'.

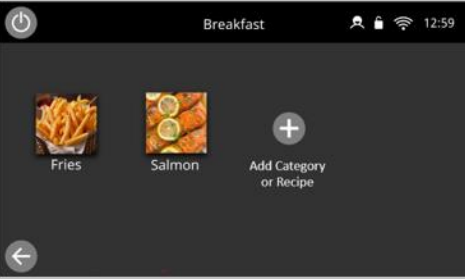
3.  Select the 'ADD CATEGORY OR RECIPE' symbol.

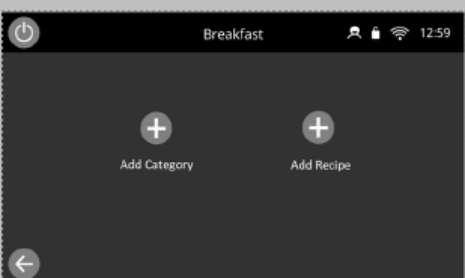
4.  In the Breakfast category you have the option to add either a category or a recipe, to add a Category select the 'Add Category' symbol.

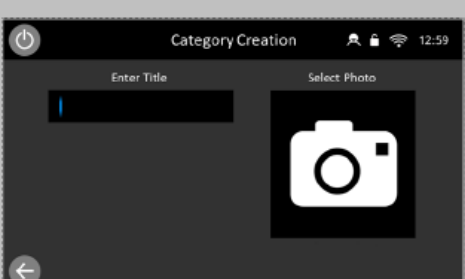
5.  This opens up the Category Creation Card, which includes the title and photo you wish to associate with this category, select the title entry or the Select photo panel to navigate to keyboard entry or photo library selection.

On completion select the green tick, the category will be saved and will return you to your created category.

■ Edit a selected Category

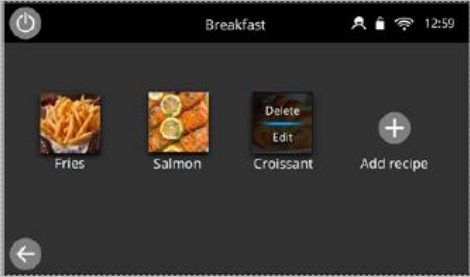
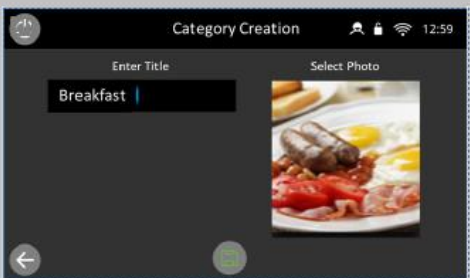
1.  Select the 'cookbook' icon from the 'Home' screen.
2.  Press and hold the image of the Category you want to edit, until the the delete/edit overlay appears.
3.  This will take you to the category card, where you can rename or re-allocate a new photo/image to the category.

Select the save button to save your changes and return to the cookbook.

■ Deleting a cooking profile group

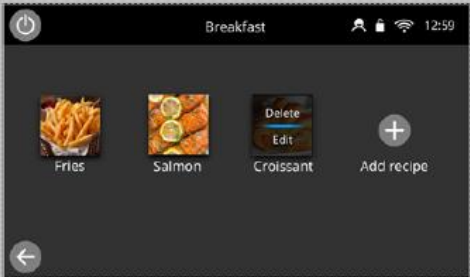
1.  Select the 'cookbook' symbol from the main menu screen, then select a category
2.  Select and hold a recipe image you want to delete.
Then select the delete button on the overlay that appears on the button.

This will prompt an on screen warning, that should be confirmed if you wish to delete or cancelled if you do not.

8.2.6 Basic settings of your microwave combination oven

Control settings and icons

1. Select the 'settings' icon from the main menu screen.

2. Enter the password 'MANAGER'.
Select the green tick to display the 'settings' menu.

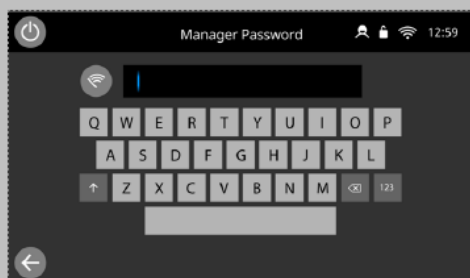

3. The 'settings' menu comprises the following functions:

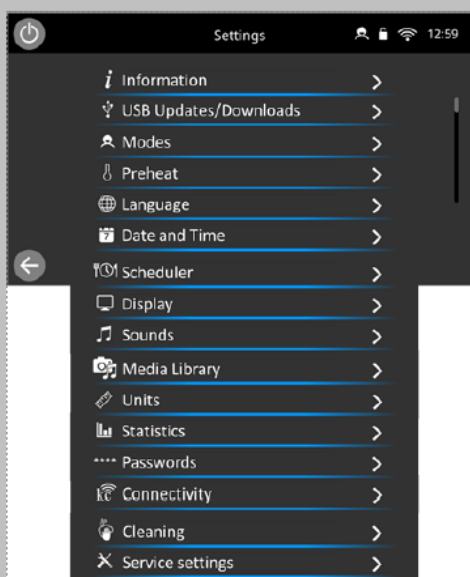

- A. Information
- B. Updates/Downloads
- C. Modes selections
- D. Preheat creations
- E. Language selections
- F. Date and time settings
- G. Scheduler settings
- H. Display setting and Options
- i. Sound options
- J. Media Library for Images and Sounds
- K. Units selection
- L. Statistic screens
- M. Password settings
- N. Connectivity options and settings
- O. Cleaning options
- P. Service Setting Menu (Password Protected screen).

Swipe to scroll up/down the menu.

Press the backspace button to exit the 'settings' menu.

■ Operating mode/navigation settings

- 

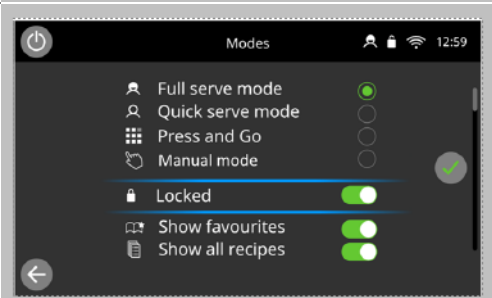
Select the 'MODES' setting in the settings list
- 

Select 'QUICK SERVE MODE' for cooking only.
Toggle 'LOCKED' to the on position (Green) or OFF (Grey) Select 'FULL SERVE MODE' to display the main menu screen. The 'chef's hat' is then used for creating cooking profiles.
Select 'PRESS & GO' MODE to quickly access recipe files only (Ideal for small menus)
Select 'MANUAL MODE' to manually cook only via the 'chef's hat' symbol on the main menu screen, cooking profiles cannot be created in manual mode.
Select 'SHOW FAVORITES' to display the favourites icon in your cookbook screens.
Select 'SHOW ALL RECIPE' to display the 'all recipes' icon in your cookbook screens.
NOTE: Show all favourites and show all recipes are not available selections in Press & Go or Manual Modes.
When finished, select GREEN TICK to save and return to the main settings menu.

■ Language options

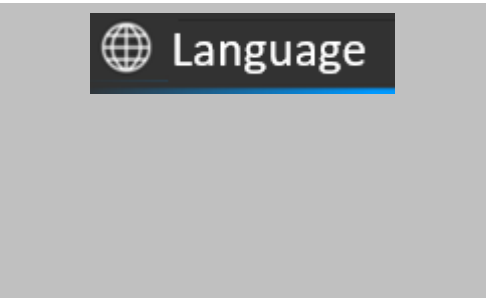
- 

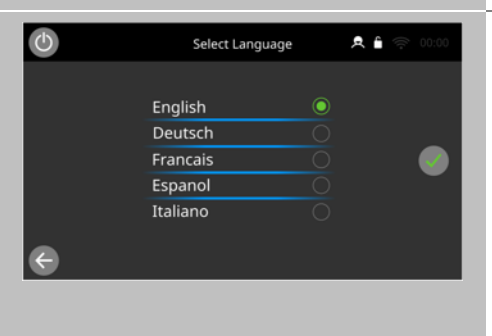
Select the 'globe' icon.
- 

Select the button of the required language from the list shown.
Note: ONLY 1 language selection is possible at any one time.
Note: Language selection enables on oven prompts, warnings and errors, to operate in the designated language, please ensure that recipe files or cook books are also available in these languages, otherwise these will default to English.
When finished, select green tick to save your selection.

■ Cavity temperature settings and preheat labels

1.



Select the 'Preheat' icon.

Up to six pre-heat temperatures can be set.

Note: The temperature options screen is only displayed at start up when two or more cavity temperatures are set above minimum.

2.

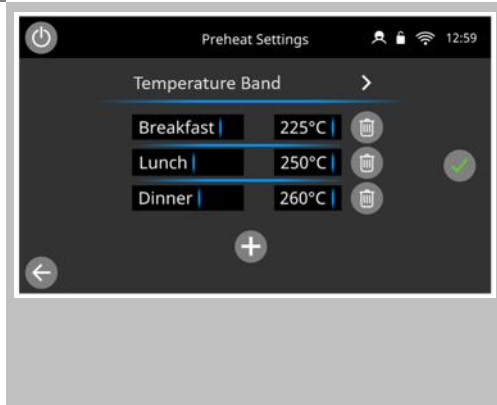

Select the 'plus' button to add a cavity preheat temperature.

Select the preheat temperature box to enter or change a preheat value.

Select the preheat name box to enter or change the preheat name for that preheat.

Select the 'trash' button next to a preheat to delete the preheat.

Adjustment to the oven's temperature band can also be made by selecting the temperature band selection at the top of this list.

When finished, select green tick to save the selections.

■ Service information and error logs

For service information and error logs refer to '*Rectifying faults*' section 12.

■ Statistics

1.



Select the 'Statistics' icon to display variable statistics for the oven.

Including:

Oven Statistics

Culinary Statistics and

Operational Statistics screens

2.

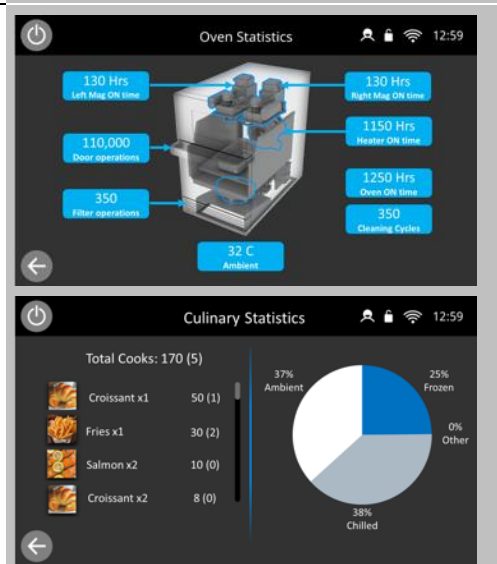

Selecting any of these shows' oven performance logging

Oven statistics: displays operational cycles of key components and systems.

Culinary statistics: displays recipe usage information.

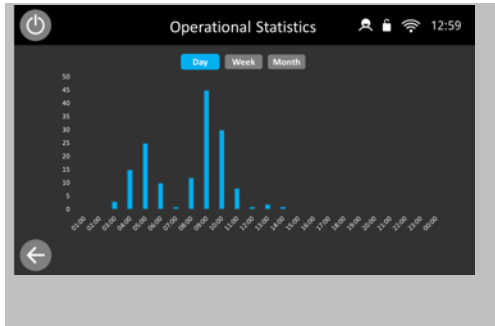

Operational statistics: displays peak usage periods on a daily, weekly, monthly basis.

When finished, select backspace to return to the statistics menu, and backspace again to return to the settings menu.

■ Date and time setting

1.

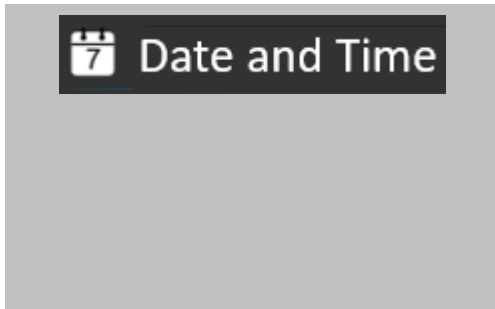

Select the 'date and time' symbol to display the setting options.

2.

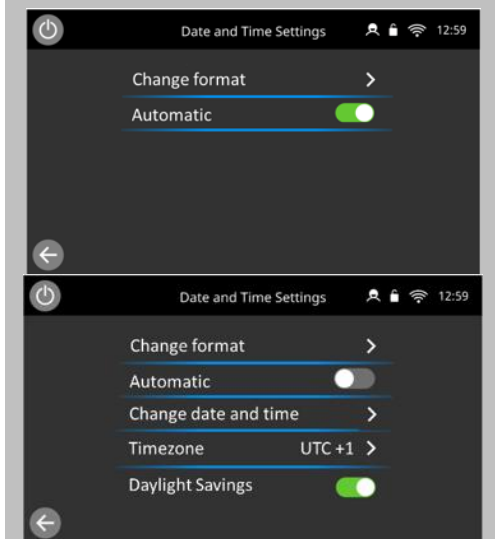

Editing of time and date can only be done if time and date settings are not set to automatic. Automatic setting requires an ethernet or Wi-Fi connection to utilize network time protocol NTP.

To change the date or time manually, deselect automatic, to reveal manual time and date settings.

Select time zone based on location search, and toggle daylight savings time.

2.1

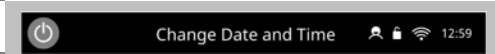

Then Select 'change date and time',

2.2



Select date and time entry box to edit the date or time entry.

2.3



Select the side tab to access AM/PM selection if the oven is set to AM/PM time format in time format.

3.

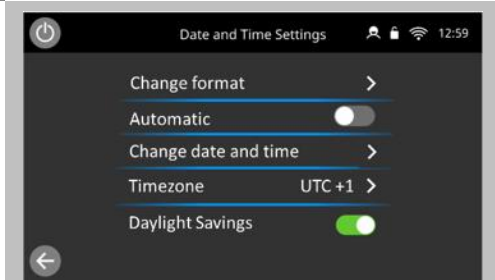

To Change time Format,

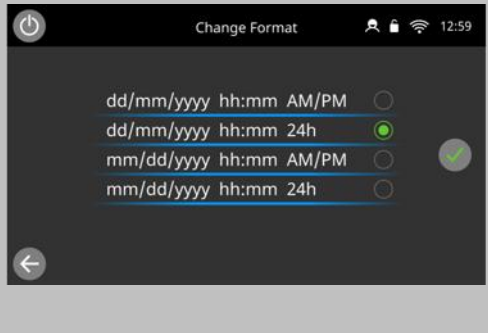
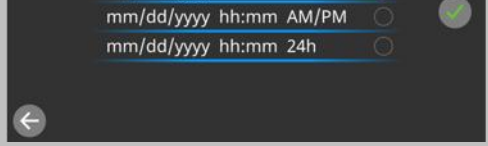
- 3.1  Select 'change format'
- 3.2 Select preferred display format of date and time.
- 3.3  Select the green tick to save.
- When finished, select backspace to return to the main settings menu.

■ Sound levels

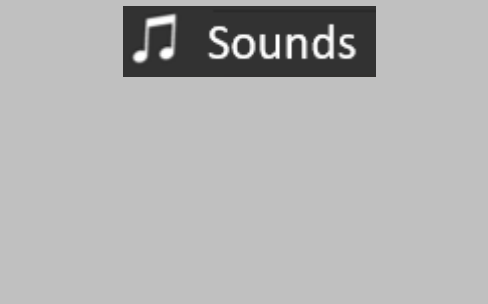
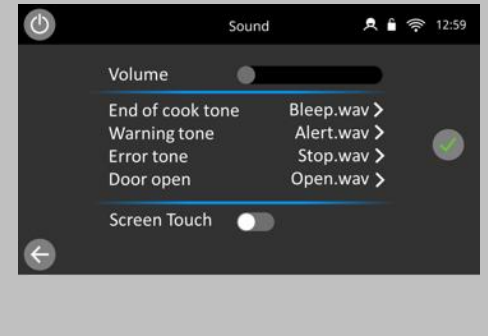
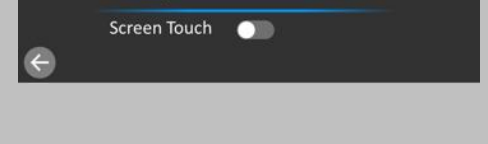
1.  Select the 'speaker' icon to access the volume, tone and further sound settings.
2.  Slide the volume bar to adjust oven sound volume to suit, to the left to lower volume, to the right to increase volume.
3. Select any of the designated sounds to allocate from the audio library.
4.  Toggle the 'screen touch' button to on, to enable sounds on all screen presses.
- When finished, select green tick to return to the main settings menu.

■ Oven timer

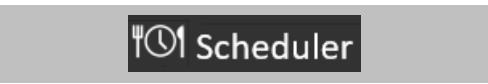
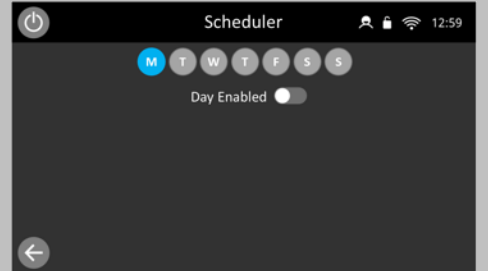
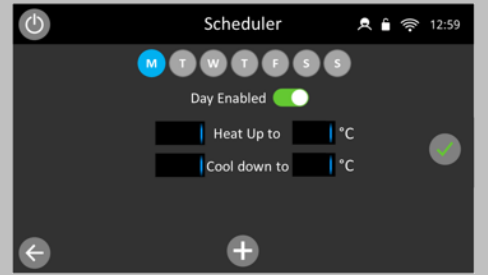
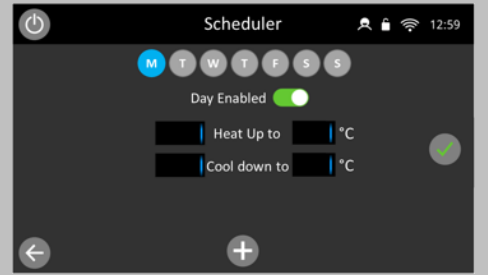
1.  Select the 'scheduler' icon.
2.  Select the 'Day enabled' selection to enable a day
3.  Select a weekday using button selection along the top of the page, to access each day set schedule.
4.  Select an empty 'time' box (maximum of 5 per day).
Alternatively clear the 'time' box using the 'wipe' symbol next to it (clears both the time and temperature for the selected line).
- On enabling a day, prompts for setting the heat up and cool down times appear.

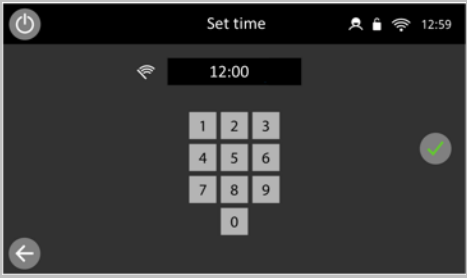
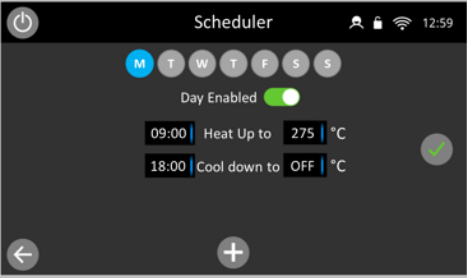
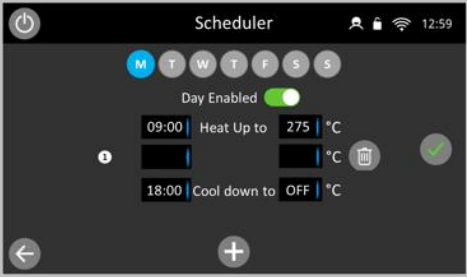
5.  Define the start time and temperature by selecting the relevant text entry boxes and inputting on the keypads.
- Select the green tick to save an input and return to the scheduler screen.
-
6.  To add interim events such as changes of temperature or instructions, select the Add icon.
- Then add the required text, image or text and image instruction, at the defined time required.
-
7.  To delete an added temperature change or instruction simply select the 'trash' button at the end of the row and follow the confirmation warning.
- Up to 10 additional scheduled events can be set on each day excluding an oven initial heat up time and temperature and the oven cool down time.
- During a timed off period, the appliance can be used simply pressing the on-screen power button, when in standby.

■ USB (Manual)

- 

1. Plug in a USB key as covered in the following section 8.2.7 and select the 'USB Updates' to manually load firmware and menu programs on the oven, or to copy any of the following files from the appliance on to the USB key;

 - Menu File
 - Event Log

Select the relevant on-screen button and await notification that a relevant file was available on the USB stick to update to the oven.
- 

2. Note: if multiple files are on the USB stick the screen will display available update files, select the appropriate update and select the green tick to apply.
- 

3. The oven will show progression of an update and notify the user when complete.

Note: When updating the ovens UI, the oven will automatically restart to the update to apply.

When finished, select backspace to return to the main settings menu.

■ Change password

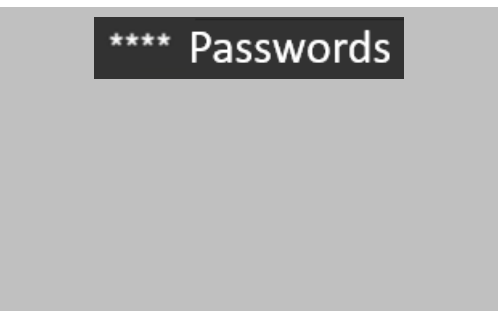

- 

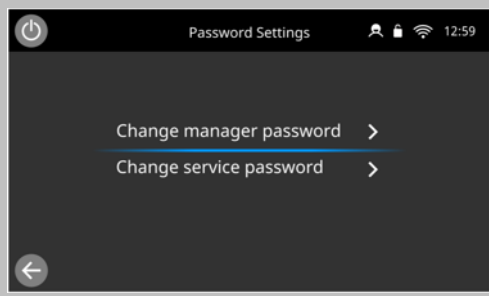
1. Select the 'Passwords' symbol to change the passwords of the appliance.

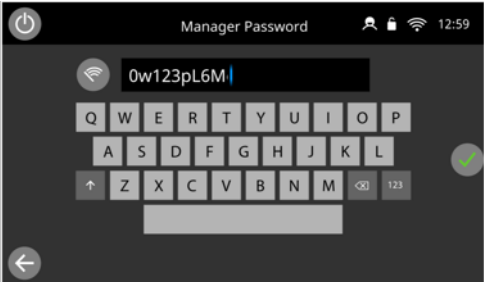
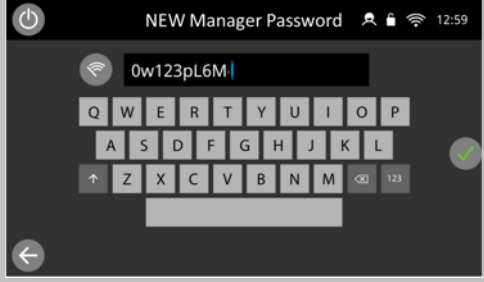

The default 'MANAGER' and the service passwords can be changed to customer specific passwords of your choice.
- 

2. Select the appliance 'settings' or 'service' menu options, dependant on the password you wish to change.

Enter the existing password and press the green tick to confirm.



3.  Then enter a new password and press the green tick.
4.  Enter your new password and press the green tick again.
5.  Confirm your NEW password and select the green tick to save your NEW password selection.
6.  When finished, select backspace to return to the main settings menu.

■ Set Display settings

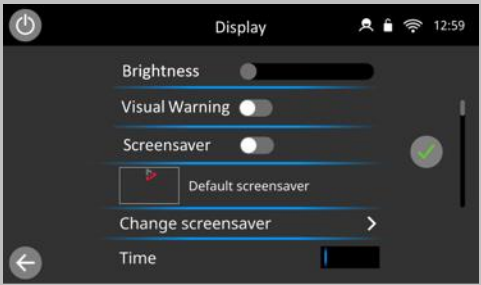
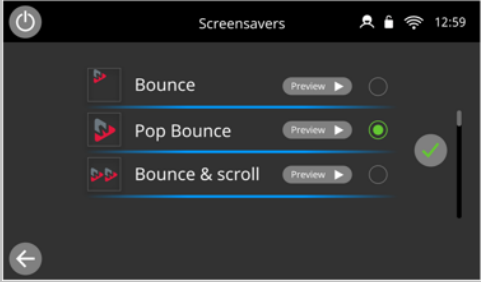
1.  Select the 'Display' symbol.
2.  Select, and drag the screen brightness bar to adjust screen brightness.
Toggle ON or OFF, the 'Visual warning' feature, which enables a screen flash at the end of cooking programs, door open messages.

2.  ENABLE screensaver by activating the toggle button, this will reveal additional selections.
To change the screensaver select the 'change screensaver' selection
3.  When making a change to the screensaver type once selected and confirming with the green tick, an option to customise the image becomes available.
An active screen saver will mask the screen showing a moving image. To use the touchscreen, tap the screen to deactivate the screen saver.

■ Connectivity

1.  The communication settings for Kitchen Connect Communications Module can be accessed by selecting the 'Connectivity' symbol.
This allows you to make a connection via Wi-Fi or the ethernet port. (The ethernet port is located on the rear of the oven, there is a black cap that should be unscrewed for access).
- 1.1  The network settings page allows access to settings for Wi-Fi, ethernet connections, and allows link access via QR code to KitchenConnect settings online.

8.2.7 Using a USB stick

■ ⚠ For your safety when using the appliance

Before starting work, it is essential that you familiarize yourself with the rules and hazard warnings specified in section 8.1.1 'Working safely with the appliance', and follow the instructions given there.

■ Purpose of the USB cover

The USB cover protects the USB port so that no water vapour can get into the control electronics during cooking or cleaning. During cooking and cleaning, there must not be a USB stick inserted and the USB port must be closed by the cover.

■ USB programs

⚠ IMPORTANT

Downloading from a USB memory stick will clear all the existing programs in the memory of the appliance. Check that the key has the correct number/code for the programs you want to load into the memory.

■ USB File format and structure

When preparing a USB key for use with your conneX you are REQUIRED to create the correct file structure on the USB stick to ensure the oven knows which files are on the stick.

USB stick should be correctly formatted (FAT 32) and have the following file structure created on the stick:

NOTE: Folder titles are case sensitive! firmware

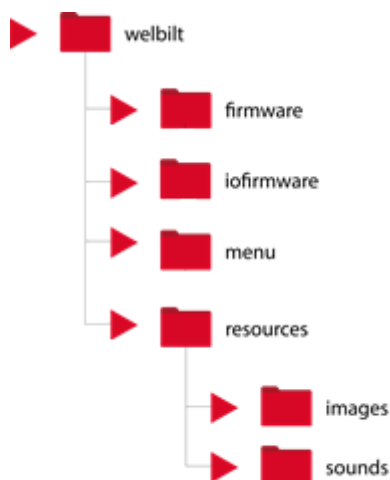

In the firmware folder is where the User interface firmware file will be placed, this will be a .tar file like the one below.

 welbilt-firmware-imx6sxsabresd.tar

In the iofirmware folder is where the oven control board firmware will be placed, this will be a .bin file like the one below.

 SRB30Z5048-e2s-V000.008.047.bin

In the menu folder is where saved menu files transferred from the oven will be placed or if you have created a menu file from the online portal the saved .zip file should be placed in this folder.

Within the resources folder is where images and sounds are stored, which can be accessed and downloaded to the media library of the oven. Ensure that under the resources folder you have an image and sounds folder to store images and sounds, that you would like to upload to the oven.

Images formats accepted are: JPG, .SVG, .PNG

Sound formats accepted are: .WAV

9 Cleaning procedures

Purpose of this chapter

This chapter summarizes the cleaning methods, the cleaning chemicals and how to handle them and the cleaning instructions. It explains the correct procedure to follow when cleaning the microwave combination oven.

9.1 Daily cleaning tasks

Daily cleaning tasks

| What must be cleaned? | Procedure | Cleaning chemicals |
|--|---|--|
| Cavity | Clean by hand with a soft cloth / paper towel | Cleaning and protective chemicals approved by the manufacturer |
| Air Filter | Clean by hand with soft cloth / sponge Rinse off after with water and dry before refitting | Common household detergent |
| Outside of appliance | Clean by hand with a soft cloth | Common household stainless steel cleaner or hard surface cleaner |
| Containers, baking sheets, shelf grills and other accessories used for cooking | <ul style="list-style-type: none"> ▪ Clean by hand with a soft non-abrasive sponge ▪ Rinse off after with water | Common household detergent |

9.2 Cleaning chemicals

Cleaning chemicals

Use solely the cleaning chemicals specified here to clean the microwave combination oven and its accessories.

| Product | Use |
|---|--|
| Merrychef® Cleaner | Cleaning the cavity and appliance door |
| Merrychef® Protector | Protecting the cavity and appliance door |
| Common household stainless steel cleaner or hard surface cleaner | Caring for the external surfaces of the microwave combination oven |
| Common household detergent: mild on skin, alkali-free, pH-neutral and odourless | <ul style="list-style-type: none"> ▪ Cleaning components and fittings according to relevant instructions ▪ Cleaning containers, baking sheets, shelf grills and other accessories used for cooking |

Handling the cleaning chemicals

You must wear personal protective equipment when using certain cleaning chemicals.

Follow the instructions given in the chapter '*Personal protective equipment*' section 3.3.7 and the current material safety datasheets pertaining to cleaning and protective chemicals recommended by the manufacturer.

Personnel must be trained regularly by the person responsible for the microwave combination oven.

9.3 Items required for cleaning

Items required for cleaning

- Merrychef® Oven Cleaner
- Merrychef® Oven Protector



- Protective rubber gloves
- Soft bristle brush (blue)
- Hard bristle brush (red)
- Non-abrasive nylon scrub pad
- Cleaning towel and cloths
- Eye protection
- Heat proof gloves (optional)
- Dust mask (optional)



NOTICE

- Never use sharp implements or harsh abrasives on any part of the appliance.
- Do not use tools.
- Do not use caustic cleaners on any part of the appliance or cavity. It will cause permanent damage to the catalytic converters.

9.4 Safe working when cleaning

Your safety and the safety of your staff

Instruct your personnel to learn the safe-working rules given in this section before starting work, and to follow them strictly. Instruct your personnel to familiarize themselves with the hazard warnings listed in this section and in further instructions below and instil in them the importance of taking the specified precautions.

Personal protective equipment for your personnel

Instruct your personnel to wear the correct personal protective equipment specified in the section '*Personal protective equipment*' section 3.7.

■ Rules for moving and setting up the wheeled trolley safely

To avoid hazards, the following rules must be observed when moving the wheeled trolley that carries the appliances (optional accessory):

- Watch out for all connecting cables when moving appliances. Never wheel over the connecting cables. Never stretch let alone pull off the connecting cables.
- The appliances must be disconnected from the electrical supply before moving the stacking trolley (optional accessory).
- The appliances must be left to cool down on the trolley before being moved.
- There must not be any food left in the appliances.
- The appliance door must be closed.
- Protective clothing must be worn if the appliance is mounted on a trolley.
- It is important to ensure that the unit is level once it is back in place.
- Once the unit is back in place, the parking brakes must be engaged again.
- Whatever the position, care must be taken to ensure that the trolley carrying the appliance does not tip over.

■ Spraying down the appliance with water

DANGER

Risk of electric shock from live parts

Water on the exterior of the appliance can cause a short-circuit, which may result in electric shock on touching the appliance.

- ▶ Do not spray the interior and exterior of the appliance with water.
- ▶ Always keep the USB cover closed during cleaning.

■ Hot surfaces

WARNING

Risk of burns from high temperatures on interior parts of the appliance

You may get burnt if you touch any of the interior parts of the cavity, the inside of the appliance door or any parts that are or were inside the oven during cooking.

- ▶ Before starting cleaning tasks, wait until the cavity has cooled to below 50°C / 122°F or use the Cool Down function to cool the cavity.
- ▶ Wear personal protective equipment.

■ Spraying water into a hot cavity

WARNING

Risk of scalding from hot steam

If water is sprayed into the hot cavity, steam will be produced that may scald.

- ▶ Before starting cleaning tasks, wait until the cavity has cooled to below 50°C / 122°F or use the 'Cool Down' function to cool the cavity.

■ Contact with cleaning chemicals

WARNING

Risk of irritation to skin, eyes and respiratory system.

Direct contact with the cleaning or protective chemicals will irritate the skin, eyes and respiratory system.

- ▶ Do not inhale the vapours or spray mist from the cleaning and protective chemicals.
- ▶ Do not let the cleaning or protective chemicals come into contact with skin, eyes or mucous membranes.
- ▶ Do not spray cleaning or protective chemicals into a cavity.
- ▶ Wear personal protective equipment.

■ Not washing off the cleaning chemicals

⚠ WARNING

Risk of food contamination from cleaning chemicals.

Wash off the cleaning chemicals from the cavity using a clean cloth and plenty of clean warm water, then wipe with a soft cloth or paper towel, to ensure no risk of food contamination from cleaning chemicals.

9.5 Cleaning procedures

■ Cleaning the microwave combination oven

This section explains how to clean your microwave combination oven.

9.5.1 Cool down and cleaning procedure

■ Purpose

With the optional 'cool down' function you can cool down the cavity quickly for cleaning your microwave combination oven sooner.

■ Cooling down the cavity

1. In 'Full Serve mode', select the 'cleaning' icon from the 'Home' screen.

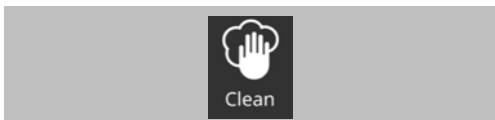



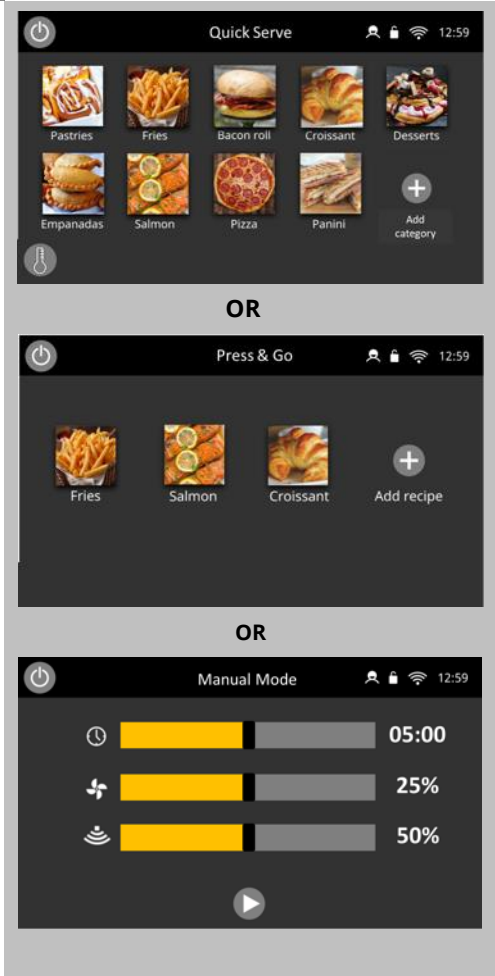

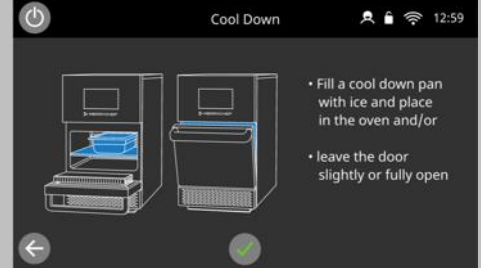
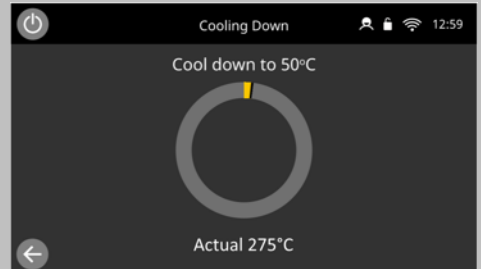
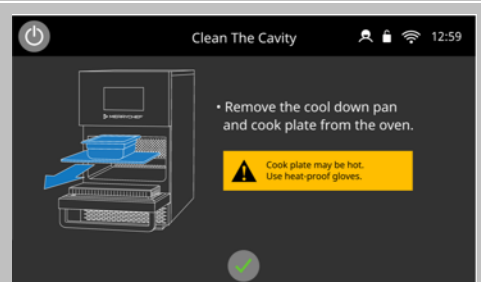

2. In 'Quick Serve', Press & Go or 'Manual mode', select the Power button'  to disable heating and to start the cooling cycle. A prompt appears.

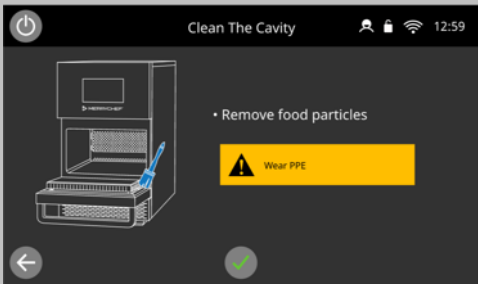

Note: Pictorial cleaning sequence is dependent on the cleaning settings set on the oven.

3.  Gather all required Personal protective equipment for cleaning. We recommend, Gloves, and a Merrychef cleaning kit, including Merrychef cleaner and Protector.
-  Selecting the green tick at the bottom of the screen progresses you through the cleaning sequence.
- Taking all necessary precautions place a suitable tray of ice cubes or cold water into the hot cavity. This speeds up the cooling process.
- Once the tray of ice is in the oven, press the green tick to continue.
- (Note: This may just indicate a door open cool down process, if ice cool down is not activated in settings)**
5.  The cool down timing progress is displayed and takes approximately 20 minutes.
6.  Once the cooling process is complete, carefully remove the cool down pan from the cavity wearing protective gloves. The pan of water should not be left in the oven overnight or when cold.
- (Note: This may just indicate to remove the cook plate, if ice cool down is not activated in the settings)**

7.  The oven is now ready for cleaning and a prompt appears on screen.
-  Apply cleaner
-  Clean the cook plate and accessories
-  Clean the oven
-  Apply Protector
- (Note: This will not appear if 'Use of protector' is not selected in cleaning settings.)**
-  Clean door seal

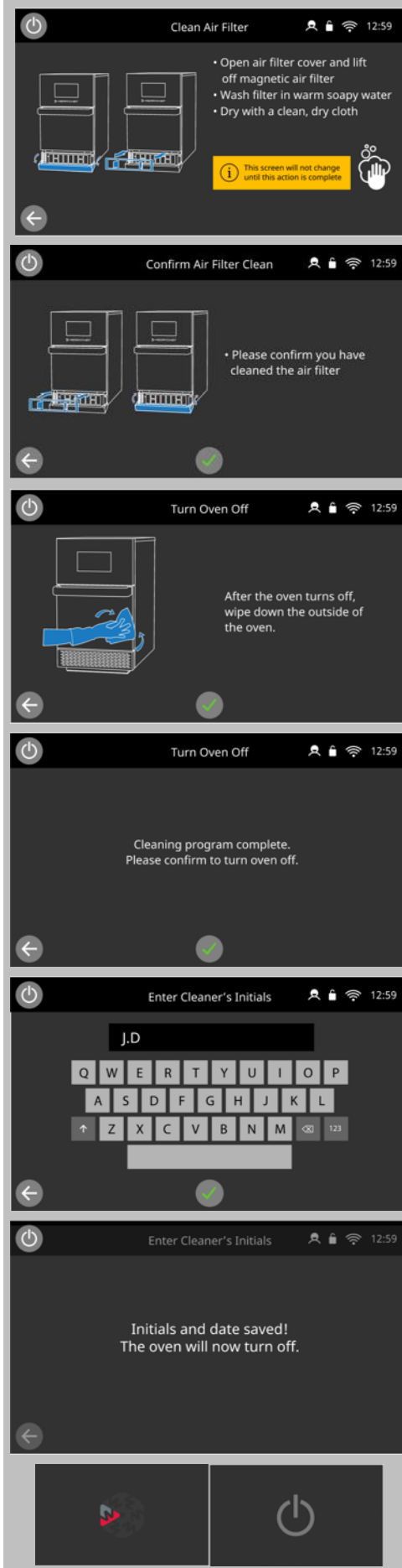

Clean Air filter

(Note: This screen will not allow progress until the air filter has been removed and replaced!)

Air filter cleaning confirmation

Clean down exterior

Cleaning complete

Cleaning sign off

(Note: This will not appear if 'Cleaning sign off' is not selected in cleaning settings.)

The oven will power down and return to the power button screen once complete.

10 Taking the appliance out of operation and disposal

■ Purpose of this chapter

In this chapter it is explained how to take your microwave combination oven out of operation and dispose of it.



10.1 Safe working when taking the appliance out of operation

■ Eligibility of personnel for taking the appliance out of operation

Work performed on the appliance while taking it out of service is performed in special operating circumstances or includes activities that require personnel to have relevant qualifications and appliance-specific knowledge that exceed the requirements for operating personnel.

The following requirements must be met by personnel:

- They are qualified employees of an authorized service company.
- Personnel have relevant training as a service engineer.
- Personnel have training specific to the appliance.

■ Personal protective equipment

Wear the personal protective equipment specified in the section '*Personal protective equipment*' section 3.7 of the '*For your safety*' chapter for the relevant tasks.

■ Rules for safe and responsible working when taking the appliance out of operation

Avoid any risks to yourself and others by following the rules below:

- The kitchen floor must always be kept dry to reduce the risk of accidents.
- The appliance door of the microwave combination oven must be closed before disposing of the appliance.
- Don't leave food in the cavity.

■ Live parts



DANGER

Risk of electric shock from live parts and loose cables

When the panels are removed, there is a risk of electric shock from touching live parts.

- Make sure that any work on the electrical system is performed solely by a competent electrician from an authorized service company.

■ Moving heavy loads



WARNING

Risk of injury from lifting incorrectly

When lifting the appliance, the weight of the appliance may lead to injuries, especially in the area of the torso.

- Use a fork-lift truck/pallet truck to move the appliance.
- When lifting the appliance, use enough people for the weight of the appliance (value depending on age and gender). Observe the local occupational safety regulations.
- Wear personal protective equipment.

■ Unsuitable supporting surface



WARNING

Risk of crushing if the appliance tips over or falls off

Body parts can be crushed if the appliance tips over or falls off.

- Make sure that the appliance is never placed on an unsuitable supporting surface.

10.2 Taking the appliance out of operation and disposal

■ Requirements

Before taking the appliance out of service, check that the appliance is de-energized.

■ Taking the appliance out of operation

To take your appliance out of operation, follow the steps for setting up and installing your appliance in the reverse order (see the chapters '*Installation*' on section 6, '*Moving the appliance*' on section 4 and '*Setting up the appliance*' on section 5).

Do not move the appliance until you have disconnected all the electrical connections.

■ Disposal

Correct disposal of this product (Waste Electrical & Electronic Equipment)

Applicable in the European Union and other European countries with separate collection systems.



This marking shown on the product, or its literature indicates that it must not be disposed with other household wastes at the end of its working life. To prevent possible harm to the environment or human health from uncontrolled waste disposal, please separate this from other types of wastes and recycle it responsibly to promote the sustainable reuse of material resources.

Household users should contact either the retailer where they purchased this product, or their local government office for details of where and how they can take this item for environmentally safe recycling.

Business users should contact their supplier and check the terms and conditions of the purchase contract. This product must not be mixed with other commercial wastes for disposal.

11 Technical data

Purpose of this chapter

This chapter contains the technical data for your microwave combination oven.

11.1 Technical data

DIMENSIONS/WEIGHTS: BOXED OVEN

| MODEL | OVERALL SIZE | | | WEIGHT | |
|------------|-------------------|-------------------|-------------------|------------------------|------------------------|
| | HEIGHT | WIDTH | DEPTH | STANDARD POWER VERSION | HIGH POWER VERSION |
| conneX® 12 | 33.7" (855 mm) | 20.5" (520 mm) | 32.3" (820 mm) | NET 133 lbs. (60 kg) | NET 151 lbs. (68.7 kg) |

| MODEL | OVERALL SIZE | | | WEIGHT |
|------------|-------------------|-------------------|-------------------|------------------------|
| | HEIGHT | WIDTH | DEPTH | |
| conneX® 16 | 33.7" (855 mm) | 24.4" (620 mm) | 32.3" (820 mm) | NET 175 lbs. (79.2 kg) |









DIMENSIONS/WEIGHTS: OVEN

| MODEL | OVERALL SIZE | | | WEIGHT | |
|------------|-------------------|---------------------|---------------------|------------------------|------------------------|
| | HEIGHT | WIDTH | DEPTH | STANDARD POWER VERSION | HIGH POWER VERSION |
| conneX® 12 | 24.4" (619 mm) | 14.0" (356.2 mm) | 25.2" (641.2 mm) | NET 111 lbs. (50 kg) | NET 130 lbs. (58.7 kg) |

| MODEL | OVERALL SIZE | | | WEIGHT |
|------------|-------------------|---------------------|---------------------|------------------------|
| | HEIGHT | WIDTH | DEPTH | |
| conneX® 16 | 24.4" (619 mm) | 18.1" (458.8 mm) | 26.9" (683.4 mm) | NET 148 lbs. (67.2 kg) |













Electrical configurations – Standard power version

conneX® 12 EMEA

| Model | Model number | Finish | ELECTRICAL SUPPLY | | | | | | | POWER OUTPUT (APPROX.) | | |
|--------------------------|------------------|-----------------|-------------------|-----------|-----------------------------|-----------------------------|---|----------------------------|------------------|----------------------------|----------------|-------------------|
| | | | Voltage | Frequency | Arrangement and connections | Plug Type | Plug image | Plug phase current rating* | Max. power input | Microwave** (IEC 705) 100% | Convected heat | Combination mode |
| conneX®12 standard power | X12GXMV5AAL1CLUK | Stainless steel | 220-230V | 50Hz | Single Phase L1+N+E | UK BS1363 |  | 13A | 2990 W | 1000 W | 2200 W | 1000 W** + 900 W |
| | X12GXMV6AAL1CLSA | | 220-230V | 60Hz | Single Phase L1+N+E | UK BS1363 |  | 13A | 2990 W | 1000 W | 2200 W | 1000 W** + 900 W |
| | X12FXMV5BDL1CLEU | | 220-230V | 50Hz | Single Phase L1+N+E | EU CEE7 |  | 16A | 3680 W | 1000 W | 2200 W | 1000 W** + 1300 W |
| | X12FXMV5ABL1CLEU | | 380-400V | 50Hz | Single Phase L1+N+E | IEC 309 5 Pin (Right Angle) |  | 16A | 3680 W | 1000 W | 2200 W | 1000 W** + 1300 W |
| | X12GXMV5AAL1BKUK | Carbon black | 220-230V | 50Hz | Single Phase L1+N+E | UK BS1363 |  | 13A | 2990 W | 1000 W | 2200 W | 1000 W** + 900 W |
| | X12GXMV6AAL1BKSA | | 220-230V | 60Hz | Single Phase L1+N+E | UK BS1363 |  | 13A | 2990 W | 1000 W | 2200 W | 1000 W** + 900 W |
| | X12FXMV5BDL1BKEU | | 220-230V | 50Hz | Single Phase L1+N+E | EU CEE7 |  | 16A | 3680 W | 1000 W | 2200 W | 1000 W** + 1300 W |
| | X12FXMV5ABL1BKEU | | 380-400V | 50Hz | Single Phase L1+N+E | IEC 309 5 Pin (Right Angle) |  | 16A | 3680 W | 1000 W | 2200 W | 1000 W** + 1300 W |





■ Electrical configurations – Standard power version

conneX® 12 APAC

| Model | Model number | Finish | ELECTRICAL SUPPLY | | | | | | | POWER OUTPUT (APPROX.) | | |
|--------------------------|------------------|-----------------|-------------------|-----------|-----------------------------|-----------------------------|---|----------------------------|------------------|----------------------------|----------------|-------------------|
| | | | Voltage | Frequency | Arrangement and connections | Plug Type | Plug image | Plug phase current rating* | Max. power input | Microwave** (IEC 705) 100% | Convected heat | Combination mode |
| conneX®12 standard power | X12GXMV5AAL1CLUK | Stainless steel | 220-230V | 50Hz | Single Phase L1+N+E | UK BS1363 (G) |  | 13A | 2990 W | 1000 W | 2200 W | 1000 W** + 900 W |
| | X12GXMV6VSL1CLKR | | 200-230V | 60Hz | Single Phase L1+N+E | KC CEE7 (F/E) |  | 16A | 3680 W | 1000 W | 2200 W | 1000 W** + 900 W |
| | X12FXMV5AVL1CLAZ | | 200-230V | 50Hz | Single Phase L1+N+E | AS/NZS 3112 (I) |  | 15A | 3680 W | 1000 W | 2200 W | 1000 W** + 900 W |
| | X12FXMV5AVL1CLCN | | 200-230V | 50Hz | Single Phase L1+N+E | AS/NZS 3112 (I) |  | 15A | 3680 W | 1000 W | 2200 W | 1000 W** + 900 W |
| | X12FXMV5BDL1CLEU | | 220-230V | 50Hz | Single Phase L1+N+E | EU CEE7 (F/E) |  | 16A | 3680 W | 1000 W | 2200 W | 1000 W** + 1300 W |
| | X12FXMV5ABL1CLEU | | 380-400V | 50Hz | Single Phase L1+N+E | IEC 309 5 Pin (Right Angle) |  | 16A | 3680 W | 1000 W | 2200 W | 1000 W** + 1300 W |
| | X12GXMV5AAL1BKUK | Carbon black | 220-230V | 50Hz | Single Phase L1+N+E | UK BS1363 (G) |  | 13A | 2990 W | 1000 W | 2200 W | 1000 W** + 900 W |
| | X12GXMV6VSL1BKKR | | 200-230V | 60Hz | Single Phase L1+N+E | KC CEE7 (F/E) |  | 16A | 3680 W | 1000 W | 2200 W | 1000 W** + 900 W |
| | X12FXMV5AVL1BKAZ | | 200-230V | 50Hz | Single Phase L1+N+E | AS/NZS 3112 (I) |  | 15A | 3680 W | 1000 W | 2200 W | 1000 W** + 900 W |
| | X12FXMV5AVL1BKCN | | 200-230V | 50Hz | Single Phase L1+N+E | AS/NZS 3112 (I) |  | 15A | 3680 W | 1000 W | 2200 W | 1000 W** + 900 W |
| | X12FXMV5BDL1BKEU | | 220-230V | 50Hz | Single Phase L1+N+E | EU CEE7 (F/E) |  | 16A | 3680 W | 1000 W | 2200 W | 1000 W** + 1300 W |
| | X12FXMV5ABL1BKEU | | 380-400V | 50Hz | Single Phase L1+N+E | IEC 309 5 Pin (Right Angle) |  | 16A | 3680 W | 1000 W | 2200 W | 1000 W** + 1300 W |







■ Electrical configurations – Standard power version

conneX® 12 US/CA

| Model | Model number | Finish | ELECTRICAL SUPPLY | | | | | | | POWER OUTPUT (APPROX.) | | |
|--------------------------|------------------|-----------------|-------------------|-----------|-----------------------------|------------|---|----------------------------|------------------|----------------------------|----------------|-------------------|
| | | | Voltage | Frequency | Arrangement and connections | Plug Type | Plug image | Plug phase current rating* | Max. power input | Microwave** (IEC 705) 100% | Convected heat | Combination mode |
| conneX®12 standard power | X12FXMV6SXL1CLUS | Stainless steel | 208-240V | 60Hz | Twin Pole 2P + GND | NEMA 6-15P |  | 15A | 3680 W | 1000 W | 2200 W | 1000 W** + 1300 W |
| | X12DXMV6SNL1CLUS | | 208-240V | 60Hz | Twin Pole 2P + GND | NEMA 6-20P |  | 20A | 4500 W | 1000 W | 2200 W | 1000 W** + 1300 W |
| | X12FXMV6SXL1BKUS | Carbon black | 208-240V | 60Hz | Twin Pole 2P + GND | NEMA 6-15P |  | 15A | 3680 W | 1000 W | 2200 W | 1000 W** + 1300 W |
| | X12DXMV6SNL1BKUS | | 208-240V | 60Hz | Twin Pole 2P + GND | NEMA 6-20P |  | 20A | 4500 W | 1000 W | 2200 W | 1000 W** + 1300 W |

■ Electrical configurations – High power versions

conneX® 12 EMEA

| Model | Model number | Finish | ELECTRICAL SUPPLY | | | | | | | POWER OUTPUT (APPROX.) | | |
|----------------------|------------------|-----------------|-------------------|-----------|-----------------------------|---------------|---|----------------------------|------------------|----------------------------|----------------|-------------------|
| | | | Voltage | Frequency | Arrangement and connections | Plug Type | Plug image | Plug phase current rating* | Max. power input | Microwave** (IEC 705) 100% | Convected heat | Combination mode |
| conneX®12 high power | X12DBMV5HEL1CLEU | Stainless steel | 220-230V | 50Hz | Single Phase L1+N+E | IEC 309 3 Pin |  | 32A | 6000 W | 2000 W | 2200 W | 2000 W** + 2200 W |
| | X12DBMV5BDL1CLEU | | 380-400V | 50Hz | Twin Phase L1+L2+N+E | IEC 309 5 Pin |  | 16A | 2500 W + 3300 W | 2000 W | 2200 W | 2000 W** + 2200 W |
| | X12DBMV5GCL1CLEU | | 380-400V | 50Hz | Twin Phase L1+L2+N+E | IEC 309 5 Pin |  | 32A | 2500 W + 3300 W | 2000 W | 2200 W | 2000 W** + 2200 W |
| | X12DBMV5HEL1BKEU | Carbon black | 220-230V | 50Hz | Single Phase L1+N+E | IEC 309 3 Pin |  | 32A | 6000 W | 2000 W | 2200 W | 2000 W** + 2200 W |
| | X12DBMV5BDL1BKEU | | 380-400V | 50Hz | Twin Phase L1+L2+N+E | IEC 309 5 Pin |  | 16A | 2500 W + 3300 W | 2000 W | 2200 W | 2000 W** + 2200 W |
| | X12DBMV5GCL1BKEU | | 380-400V | 50Hz | Twin Phase L1+L2+N+E | IEC 309 5 Pin |  | 32A | 2500 W + 3300 W | 2000 W | 2200 W | 2000 W** + 2200 W |

■ Electrical configurations – High power version

conneX® 12 APAC

| Model | Model number | Finish | ELECTRICAL SUPPLY | | | | | | | POWER OUTPUT (APPROX.) | | |
|----------------------|------------------|-----------------|-------------------|-----------|-----------------------------|-----------------------------|------------|----------------------------|------------------|----------------------------|----------------|-------------------|
| | | | Voltage | Frequency | Arrangement and connections | Plug Type | Plug image | Plug phase current rating* | Max. power input | Microwave** (IEC 705) 100% | Convected heat | Combination mode |
| conneX®12 high power | X12DBMV6VHE1CLKR | Stainless steel | 200-230V | 60Hz | Single Phase L1+N+E | IEC 309 3 Pin | | 32A | 6000 W | 2000 W | 2200 W | 2000 W** + 2200 W |
| | X12DBMV5HML1CLAZ | | 200-230V | 50Hz | Single Phase L1+N+E | AS/NZ 3 Pin | | 32A | 6000 W | 2000 W | 2200 W | 2000 W** + 2200 W |
| | X12DBMV5GKL1CLAZ | | 380-400V | 50Hz | Twin Phase L1+L2+N+E | AS/NZ 5 Pin | | 20A | 2500 W + 3300 W | 2000 W | 2200 W | 2000 W** + 2200 W |
| | X12DBMV5KEL1CLCN | | 200-230V | 50Hz | Single Phase L1+N+E | IEC 309 3 Pin | | 32A | 6000 W | 2000 W | 2200 W | 2000 W** + 2200 W |
| | X12DBMV5HEL1CLEU | | 220-230V | 50Hz | Single Phase L1+N+E | IEC 309 3 Pin | | 32A | 6000 W | 2000 W | 2200 W | 2000 W** + 2200 W |
| | X12DBMV5BDL1CLEU | | 380-400V | 50Hz | Twin Phase L1+L2+N+E | IEC 309 5 Pin (Right Angle) | | 16A | 2500 W + 3300 W | 2000 W | 2200 W | 2000 W** + 2200 W |
| | X12DBMV5GCL1CLEU | | 380-400V | 50Hz | Twin Phase L1+L2+N+E | IEC 309 5 Pin | | 32A | 2500 W + 3300 W | 2000 W | 2200 W | 2000 W** + 2200 W |
| | X12DBMV6VHE1BKKR | Carbon black | 200-230V | 60Hz | Single Phase L1+N+E | IEC 309 3 Pin | | 32A | 6000 W | 2000 W | 2200 W | 2000 W** + 2200 W |
| | X12DBMV5HML1BKAZ | | 200-230V | 50Hz | Single Phase L1+N+E | AS/NZ 3 Pin | | 32A | 6000 W | 2000 W | 2200 W | 2000 W** + 2200 W |
| | X12DBMV5GKL1BKAZ | | 380-400V | 50Hz | Twin Phase L1+L2+N+E | AS/NZ 5 Pin | | 20A | 2500 W + 3300 W | 2000 W | 2200 W | 2000 W** + 2200 W |
| | X12DBMV5KEL1BKCN | | 200-230V | 50Hz | Single Phase L1+N+E | IEC 309 3 Pin | | 32A | 6000 W | 2000 W | 2200 W | 2000 W** + 2200 W |
| | X12DBMV5HEL1BKEU | | 220-230V | 50Hz | Single Phase L1+N+E | IEC 309 3 Pin | | 32A | 6000 W | 2000 W | 2200 W | 2000 W** + 2200 W |
| | X12DBMV5BDL1BKEU | | 380-400V | 50Hz | Twin Phase L1+L2+N+E | IEC 309 5 Pin (Right Angle) | | 16A | 2500 W + 3300 W | 2000 W | 2200 W | 2000 W** + 2200 W |
| | X12DBMV5GCL1BKEU | | 380-400V | 50Hz | Twin Phase L1+L2+N+E | IEC 309 5 Pin | | 32A | 2500 W + 3300 W | 2000 W | 2200 W | 2000 W** + 2200 W |

■ Electrical configurations – High power versions

conneX® 12 US/CA

| Model | Model number | Finish | ELECTRICAL SUPPLY | | | | | | | POWER OUTPUT (APPROX.) | | |
|----------------------|------------------|-----------------|-------------------|-----------|-----------------------------|-------------|------------|----------------------------|------------------|----------------------------|----------------|-------------------|
| | | | Voltage | Frequency | Arrangement and connections | Plug Type | Plug image | Plug phase current rating* | Max. power input | Microwave** (IEC 705) 100% | Convected heat | Combination mode |
| conneX®12 high power | X12DBMV6DHL1CLUS | Stainless steel | 208-240V | 60Hz | Twin Pole 2P + GND | NEMA L6-30P | | 30A | 6000 W | 2000 W | 2200 W | 2000 W** + 2200 W |
| | X12DBMV6DFL1CLUS | | 208-240V | 60Hz | Twin Pole 2P + GND | NEMA 6-30P | | 30A | 6000 W | 2000 W | 2200 W | 2000 W** + 2200 W |
| | X12DBMV6DHL1BKUS | Carbon black | 208-240V | 60Hz | Twin Pole 2P + GND | NEMA L6-30P | | 30A | 6000 W | 2000 W | 2200 W | 2000 W** + 2200 W |
| | X12DBMV6DFL1BKUS | | 208-240V | 60Hz | Twin Pole 2P + GND | NEMA 6-30P | | 30A | 6000 W | 2000 W | 2200 W | 2000 W** + 2200 W |















■ Electrical configurations – High power versions

conneX® 16 EMEA

| Model | Model number | Finish | ELECTRICAL SUPPLY | | | | | | | POWER OUTPUT (APPROX.) | | |
|----------------------|------------------|-----------------|-------------------|-----------|-----------------------------|---------------|------------|----------------------------|------------------|----------------------------|----------------|-------------------|
| | | | Voltage | Frequency | Arrangement and connections | Plug Type | Plug image | Plug phase current rating* | Max. power input | Microwave** (IEC 705) 100% | Convected heat | Combination mode |
| conneX16® high power | X16DBMV5HEL1CLEU | Stainless steel | 220-230V | 50Hz | Single Phase L1+N+E | IEC 309 3 Pin | | 32A | 6000 W | 2000 W | 3200 W | 2000 W** + 3200 W |
| | X16DBMV5BDL1CLEU | | 380-400V | 50Hz | Twin Phase L1+L2+N+E | IEC 309 5 Pin | | 16A | 2500 W + 3300 W | 2000 W | 3200 W | 2000 W** + 3200 W |
| | X16DBMV5GCL1CLEU | | 380-400V | 50Hz | Twin Phase L1+L2+N+E | IEC 309 5 Pin | | 32A | 2500 W + 3300 W | 2000 W | 3200 W | 2000 W** + 3200 W |
| | X16DBMV5HEL1BKEU | Carbon black | 220-230V | 50Hz | Single Phase L1+N+E | IEC 309 3 Pin | | 32A | 6000 W | 2000 W | 3200 W | 2000 W** + 3200 W |
| | X16DBMV5BDL1BKEU | | 380-400V | 50Hz | Twin Phase L1+L2+N+E | IEC 309 5 Pin | | 16A | 2500 W + 3300 W | 2000 W | 3200 W | 2000 W** + 3200 W |
| | X16DBMV5GCL1BKEU | | 380-400V | 50Hz | Twin Phase L1+L2+N+E | IEC 309 5 Pin | | 32A | 2500 W + 3300 W | 2000 W | 3200 W | 2000 W** + 3200 W |





Electrical configurations – High power versions

conneX® 16 APAC

| Model | Model number | Finish | ELECTRICAL SUPPLY | | | | | | | POWER OUTPUT (APPROX.) | | |
|-------------------------|------------------|-----------------|-------------------|-----------|-----------------------------|---------------|---|----------------------------|------------------|----------------------------|----------------|-------------------|
| | | | Voltage | Frequency | Arrangement and connections | Plug Type | Plug image | Plug phase current rating* | Max. power input | Microwave** (IEC 705) 100% | Convected heat | Combination mode |
| conneX16® high power | X16DBMV6VHE1CLKR | Stainless Steel | 200-230V | 60Hz | Single Phase L1+N+E | IEC 309 3 Pin |  | 32A | 6000 W | 2000 W | 3200 W | 2000 W** + 3200 W |
| | X16DBMV5HML1CLAZ | | 200-230V | 50Hz | Single Phase L1+N+E | AS/NZ 3 Pin |  | 32A | 6000 W | 2000 W | 3200 W | 2000 W** + 3200 W |
| | X16DBMV5GKL1CLAZ | | 380-400V | 50Hz | Twin Phase L1+L2+N+E | AS/NZ 5 Pin |  | 20A | 2500 W + 3300 W | 2000 W | 3200 W | 2000 W** + 3200 W |
| | X16DBMV5KEL1CLCN | | 200-230V | 50Hz | Single Phase L1+N+E | IEC 309 3 Pin |  | 32A | 6000 W | 2000 W | 3200 W | 2000 W** + 3200 W |
| | X16DBMV5HEL1CLEU | | 220-230V | 50Hz | Single Phase L1+N+E | IEC 309 3 Pin |  | 32A | 6000 W | 2000 W | 3200 W | 2000 W** + 3200 W |
| | X16DBMV5BDL1CLEU | | 380-400V | 50Hz | Twin Phase L1+L2+N+E | IEC 309 5 Pin |  | 16A | 2500 W + 3300 W | 2000 W | 3200 W | 2000 W** + 3200 W |
| | X16DBMV5GCL1CLEU | | 380-400V | 50Hz | Twin Phase L1+L2+N+E | IEC 309 5 Pin |  | 32A | 2500 W + 3300 W | 2000 W | 3200 W | 2000 W** + 3200 W |
| | X16DBMV6VHE1BKKR | Carbon Black | 200-230V | 60Hz | Single Phase L1+N+E | IEC 309 3 Pin |  | 32A | 6000 W | 2000 W | 3200 W | 2000 W** + 3200 W |
| | X16DBMV5HML1BKAZ | | 200-230V | 50Hz | Single Phase L1+N+E | AS/NZ 3 Pin |  | 32A | 6000 W | 2000 W | 3200 W | 2000 W** + 3200 W |
| | X16DBMV5GKL1BKAZ | | 380-400V | 50Hz | Twin Phase L1+L2+N+E | AS/NZ 5 Pin |  | 20A | 2500 W + 3300 W | 2000 W | 3200 W | 2000 W** + 3200 W |
| | X16DBMV5KEL1BKCN | | 200-230V | 50Hz | Single Phase L1+N+E | IEC 309 3 Pin |  | 32A | 6000 W | 2000 W | 3200 W | 2000 W** + 3200 W |
| | X16DBMV5HEL1BKEU | | 220-230V | 50Hz | Single Phase L1+N+E | IEC 309 3 Pin |  | 32A | 6000 W | 2000 W | 3200 W | 2000 W** + 3200 W |
| | X16DBMV5BDL1BKEU | | 380-400V | 50Hz | Twin Phase L1+L2+N+E | IEC 309 5 Pin |  | 16A | 2500 W + 3300 W | 2000 W | 3200 W | 2000 W** + 3200 W |
| | X16DBMV5GCL1BKEU | | 380-400V | 50Hz | Twin Phase L1+L2+N+E | IEC 309 5 Pin |  | 32A | 2500 W + 3300 W | 2000 W | 3200 W | 2000 W** + 3200 W |

Electrical configurations – High power versions

conneX® 16 US/CA

| Model | Model number | Finish | ELECTRICAL SUPPLY | | | | | | | POWER OUTPUT (APPROX.) | | |
|-------------------------|------------------|-----------------|-------------------|-----------|-----------------------------|-------------|---|----------------------------|------------------|----------------------------|----------------|-------------------|
| | | | Voltage | Frequency | Arrangement and connections | Plug Type | Plug image | Plug phase current rating* | Max. power input | Microwave** (IEC 705) 100% | Convected heat | Combination mode |
| conneX16® high power | X16DBMV6DHL1CLUS | Stainless Steel | 208-240V | 60Hz | Twin Pole 2P + GND | NEMA L6-30P |  | 30A | 6000 W | 2000 W | 3200 W | 2000 W** + 3200 W |
| | X16DBMV6DFL1CLUS | | 208-240V | 60Hz | Twin Pole 2P + GND | NEMA 6-30P |  | 30A | 6000 W | 2000 W | 3200 W | 2000 W** + 3200 W |
| | X16DBMV6DHL1BKUS | Carbon Black | 208-240V | 60Hz | Twin Pole 2P + GND | NEMA L6-30P |  | 30A | 6000 W | 2000 W | 3200 W | 2000 W** + 3200 W |
| | X16DBMV6DFL1BKUS | | 208-240V | 60Hz | Twin Pole 2P + GND | NEMA 6-30P |  | 30A | 6000 W | 2000 W | 3200 W | 2000 W** + 3200 W |

Regulatory standards compliance

| | |
|--------------------------|----------------------------------|
| Degree of protection | IPX3 |
| Noise emission (Standby) | max. 65 [dBA] |
| Approval marks | |
| Tested safety | UKCA, CE, CB (IEC), UL (Pending) |
| Hygiene | UL-EPH (NSF/ANSI 4) (Pending) |

11.2 Dimensional drawings

connex 12

No clearance required around the sides of the unit, a 2" clearance is needed above the unit. The item is not intended for built in appliances.

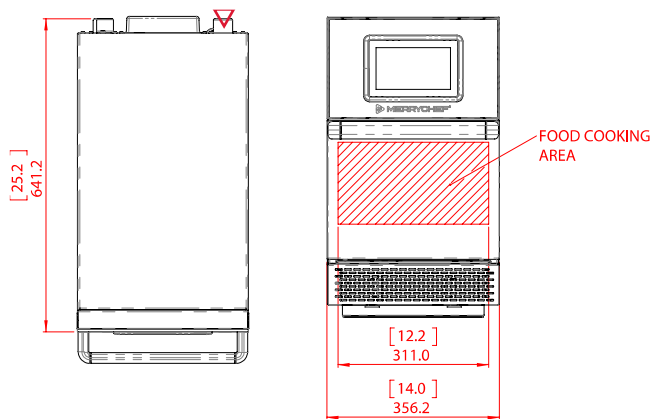
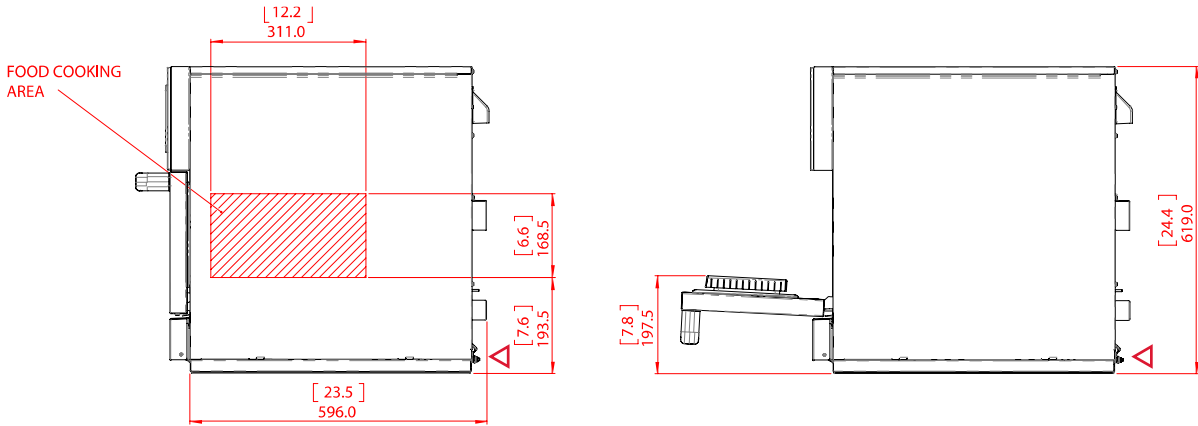

△ = mains cable exit.
Mains cable length is 6ft/1.8m.

connex 16

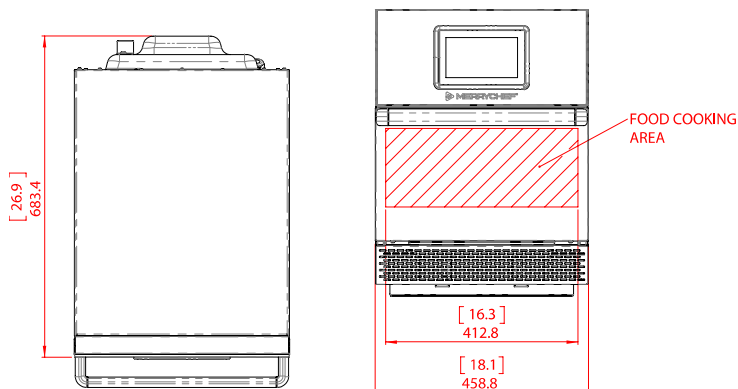
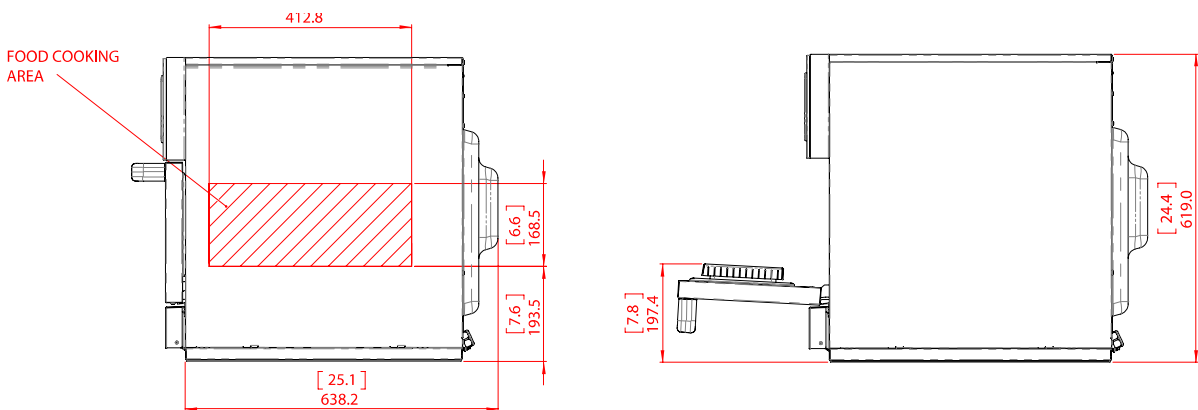

△ = mains cable exit.
Mains cable length is 6ft/1.8m.

12 Servicing information

Purpose of this chapter

To inform about the correct procedure to follow during servicing and summarizes possible faults with the appliance and errors that may arise during operation.

12.1 Warranty information and contacting customer service

Warranty information

In order to be able to claim under the warranty for the microwave combination oven, the appliance must be installed in accordance with the instructions in the Installation and User Manual by a qualified service engineer from an authorized service company.

The warranty does not cover damage resulting from improper setup, installation, use, cleaning, use of cleaning chemicals, servicing or repair.

Required information

Please have the following appliance data to hand when contacting our customer service:

- Model, or item number of your appliance (see '*Identifying your microwave combination oven*' section 1.1.4)
- Serial number of your appliance (see '*Identifying your microwave combination oven*' section 1.1.4)

Contact data

Welbilt UK Ltd.
Ashbourne House, The Guildway,
Old Portsmouth Road
Guildford, GU3 1LR
United Kingdom

Phone (head office) (+44) (0) 1483 464900

Fax (+44) (0) 1483 464905

Internet www.merrychef.com
www.welbilt.com

12.2 Rectifying faults: problems in operation

Fault finding chart

Although every effort is made to ensure your oven will continue to perform to a high standard, please check the chart to see if the problem can be easily resolved before contacting your service agent.

| Problem | Possible cause | Remedy |
|--|---|--|
| The appliance does not work, and the display screen is blank | The appliance has no power | <ul style="list-style-type: none"> ▪ Check if there is a power cut. ▪ Check if the isolator switch is ON or the appliance is plugged in correctly. |
| Some screen controls do not work | Unauthorised access | Contact an authorised user. |
| Display shows a warning message | Details are shown on screen | Follow the instructions displayed. |
| The appliance does not cook the food correctly | <ul style="list-style-type: none"> ▪ Appliance is not clean ▪ Food not at correct temperature ▪ Modified or wrong program selected ▪ Food wrapped ▪ Food removed early | <ul style="list-style-type: none"> ▪ Clean the appliance (see '<i>Cleaning Instructions</i>' on section 9) ▪ Use the correct cooking program. ▪ Unwrap food. ▪ Check if all the cooking stages have been followed correctly. |
| The appliance does not finish cooking | <ul style="list-style-type: none"> ▪ Warning message displayed ▪ The appliance door is open ▪ No air filter or incorrectly fitted ▪ Overheating of the appliance | <ul style="list-style-type: none"> ▪ Close the appliance door. ▪ Refit the air filter. ▪ Allow the appliance to cool down. ▪ Check and remove any restrictions around the air vents. |
| Display shows an error code | Malfunction of the appliance | Note the error code and contact your service agent. |



Expanding Your Opportunities

WELBILT UK LTD., ASHBOURNE HOUSE, THE GUILDWAY, OLD PORTSMOUTH ROAD, GUILDFORD, GU3 1LR, UK. | +1 4 4 (0)14 83 4 6 4900 | WWW.MERRYCHEF.COM | WELBILT GERMANY +49 2772 58050 | WELBILT ITALY +39 051 092 0590 | WELBILT IBERIA +34 902 201 069 | WELBILT RUSSIA +79164993215 | WELBILT POLAND +48 737 176 636 | WELBILT MIDDLE EAST +971 432 63313 | WELBILT CHINA +86 21 6 0 667010 | WELBILT INDIA + 91 124 4763700 | WELBILT SINGAPORE + 65 6420 080 | WELBILT UNITED STATES +1 877 375 9300 | WELBILT CANADA +1 888 442 7526 | WELBILT MEXICO +52 55 5357 7100