



Heated Buffet Bar

Instruction manual



**Model • Modèle • Modell • Modello • Modelo • Malli:
CR904**

Safety Tips

- Position on a flat, stable surface.
- A service agent/qualified technician should carry out installation and any repairs if required. Do not remove any components on this product.
- Consult Local and National Standards to comply with the following:
 - Health and Safety at Work Legislation
 - BS EN Codes of Practice
 - Fire Precautions
 - IEE Wiring Regulations
 - Building Regulations
- **Warning! Hot surface!** Always wear safety gloves when placing or removing foods. 
- DO NOT immerse the appliance in water, or use jet/pressure washers to clean the appliance.
- DO NOT overfill the appliance. Keep the water level below the '**Max**' level.
- DO NOT allow the water level to drop below the '**Min**' level during operation.
- DO NOT move the appliance when it contains hot liquid.
- Do not use the appliance for anything other than its intended use.
- Always switch off and disconnect the power supply to the appliance when not in use.
- Not suitable for outdoor use.
- Keep all packaging away from children. Dispose of the packaging in accordance to the regulations of local authorities.
- If the power cord is damaged, it must be replaced by a Buffalo agent or a recommended qualified technician in order to avoid a hazard.

- This appliance must only be used in accordance with these instructions and by persons competent to do so.
- This appliance is not intended for use by persons (including children) with reduced physical, sensory or mental capabilities, or lack of experience and knowledge, unless they have been given supervision or instruction concerning the use of the appliance by a person responsible for their safety.
- Children should be supervised to ensure that they do not play with the appliance.

Introduction

Please take a few moments to carefully read through this manual. Correct maintenance and operation of this machine will provide the best possible performance from your Buffalo product.

Pack Contents

The following is included:

- Buffalo Heated Buffet Bar
- Gastranorm spacer bars
- Instruction Manual

Buffalo prides itself on quality and service, ensuring that at the time of packaging the contents are supplied fully functional and free of damage.

Should you find any damage as a result of transit, please contact your Buffalo dealer immediately.

Installation

1. Remove the appliance from the packaging. Make sure that all protective plastic film and coatings are thoroughly removed from all surfaces.
2. Maintain a distance of 20cm (7 inches) between the unit and walls or other objects for ventilation.



Note: Before using the appliance for the first time, clean the shelves and interior with soapy water.

3. Set the brakes on the castors to keep the appliance in position.
4. Check to make sure the drainage tap at the upper end of the drainage hose is already closed.

Operation

Storing Food

To get the best results from your Buffalo appliance, follow these instructions:

- The appliance is designed for keeping food warm only, not for cooking. Always pre-cook the food.
- Only store foodstuffs in the appliance when it has reached the correct operating temperature.
- Use the spacer bars provided to fill any gaps (they are not required to support each GN pans).
- Always cover the pan with lid when not in use.

Raise/Lower the glass cover

1. To raise the glass cover, unlock the buckles at two sides first. The glass cover will rise automatically. Then turn the screws clockwise to tighten.
2. To lower the glass cover, loosen the screws first. Then press down the glass cover on both ends simultaneously. Finally lock the buckles in place.

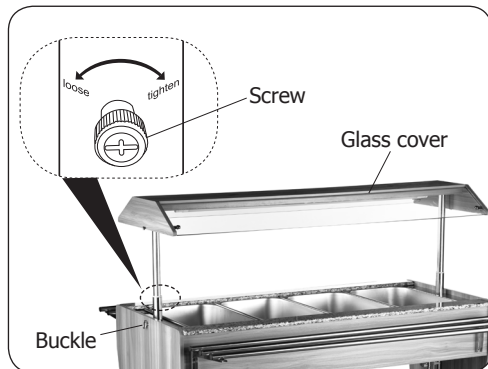

Note: Do not place heavy objects (e.g., stacked plates) on the glass cover or folding shelves. Use the fixed shelves instead.

Filling the water tank

1. Fill the tank with water to a level between the 'Min' and 'Max' marks on the inside of the tank.







Note: Never use the appliance without water in the tank, or the food will burn and the appliance will overheat and may get damaged.

2. Insert the 1/1 GN pans (not supplied) into the water tank.

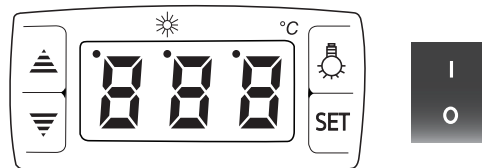
Control panel

The control panel is located at the rear of the appliance.



	Heating indicator light: It is on when the appliance is heating. It is off when the set temperature is reached.
	Up Button
	Down Button
	Light button
SET	Set button
I/O	Power switch



Turn On

1. Ensure the power switch is set to [O] and turn on at the socket.
2. Switch on the Power [I].

Illumination

Press the light button  to switch ON/OFF the lamp underneath the glass cover.

Adjusting the Temperature

1. Press **SET** button. The set temperature is displayed.
2. Press up button  or down button  to change the set temperature.
3. Press **SET** button to exit.
4. When the set temperature is reached, the heating indicator light goes out.
5. The appliance is now ready for food to be put inside and kept warm.

Maintaining Water Levels

1. The appliance will beep when the water level is too low. Switch off the Power [**O**].
2. Remove the GN pans while wearing safety gloves. Then add water carefully to prevent hot water splashing out.

Always keep the water level between the 'Min' and 'Max' marks on the inside of the tank during operation.

Damage to the heating element can occur if the tank boils dry and the element may have to be replaced. This is not covered by the Buffalo warranty.

Thermal Cut-Out Reset

- This appliance is fitted with a Thermal Cut-Out safety feature. Should the temperature exceed safe levels the appliance will automatically cut power.
- Allow the appliance to cool for 30-45 minutes.

Cleaning, Care & Maintenance



Switch off and disconnect the appliance from the power supply. Then allow to cool down before cleaning and maintenance.

- Wipe down the exterior of the appliance with a damp cloth..
- Remove the GN pans and clean with warm, soapy water and a damp cloth.
- Open the drainage tap to empty the water tank. Then close the tap.
- Clean the interior of the appliance as often as possible.
- Do not use abrasive cleaning agents. These can leave harmful residues.
- Always wipe dry after cleaning.

Replacing the Lamp

Call your Polar dealer or a qualified electrician. The Lamp Assembly is available to purchase as a spare part.

Troubleshooting

Fault	Probable Cause	Solution
The appliance is not working	The unit is not switched on	Check the unit is plugged in correctly and switched on
	Plug and lead are damaged	Call Buffalo agent or qualified Technician
	Fuse in the plug has blown	Replace the fuse
	Power supply	Check power supply
	Internal wiring fault	Call Buffalo agent or qualified Technician
	Auto re-set activated	Allow product to cool for 30-45 minutes

Technical Specifications

Model	Voltage	Power	Current	Temp. range	Dimensions H x W x D mm	Weight
CR904	220-240V~ 50Hz	2000W	9A	30°C - 90°C	1370 x 1490 x 765	104kg

Electrical Wiring

This appliance is supplied with a 3 pin, moulded, BS1363 plug and lead, with a 13 amp fuse as standard.

The plug is to be connected to a suitable mains socket.

This appliance is wired as follows:

- Live wire (coloured brown) to terminal marked L
- Neutral wire (coloured blue) to terminal marked N
- Earth wire (coloured green/yellow) to terminal marked E

This appliance must be earthed.



If in doubt consult a qualified electrician.

Electrical isolation points must be kept clear of any obstructions. In the event of any emergency disconnection being required they must be readily accessible.

Compliance

The WEEE logo on this product or its documentation indicates that the product must not be disposed of as household waste. To help prevent possible harm to human health and/or the environment, the product must be disposed of in an approved and environmentally safe recycling process. For further information on how to dispose of this product correctly, contact the product supplier, or the local authority responsible for waste disposal in your area.



BUFFALO parts have undergone strict product testing in order to comply with regulatory standards and specifications set by international, independent, and federal authorities.

BUFFALO products have been approved to carry the following symbol:

All rights reserved. No part of these instructions may be produced or transmitted in any form or by any means, electronic, mechanical, photocopying, recording or otherwise, without the prior written permission of BUFFALO.

Every effort is made to ensure all details are correct at the time of going to press, however, BUFFALO reserve the right to change specifications without notice.

DECLARATION OF CONFORMITY

• **Conformiteitsverklaring** • **Déclaration de conformité** • **Konformitätserklärung** • **Dichiarazione di conformità** •
• **Declaración de conformidad** • **Declaração de conformidade**

Equipment Type • Uitrustingstype • Type d'équipement • Gerätetyp • Tipo di apparecchiatura • Tipo de equipo • Tipo de equipamento	Heated Buffet Bar	
Model • Modèle • Modell • Modello • Modelo • Malli	CR904	
Application of Council Directives(s) Toepassing van Europese Richtlijn(en) • Application de la/des directive(s) du Conseil • Anwendbare EU-Richtlinie(n) • Applicazione delle Direttive • Aplicación de la(s) directiva(s) del consejo • Aplicação de directiva(s) do Conselho	Low Voltage Directive (LVD) 2014/35/EC EN 60335-1:2012 +A11:2014 EN 60335-2-49: 2003 +A1:2008 +A11:2012 EN 62233:2008	
	Electro-Magnetic Compatibility (EMC) Directive 2014/30/EU EN 61000-6-3:2007 +A1:2011 EN 61000-6-1:2007	
	Restriction of Hazardous Substances Directive (RoHS) 2015/863 amending Annex II to Directive 2011/65/EU	
Producer Name • Naam fabrikant • Nom du producteur • Name des Herstellers • Nome del produttore • Nombre del fabricante • Nome do fabricante	Buffalo	
Producer Address • Adres fabrikant • Adresse du producteur • Anschrift des Herstellers • Indirizzo del produttore • Dirección del fabricante • Morada do fabricante	Fourth Way, Avonmouth, Bristol, BS11 8TB United Kingdom	42 North Point Business Park New Mallow Road Cork Ireland

I, the undersigned, hereby declare that the equipment specified above conforms to the above Directive(s) and Standard(s).
Ik, de ondergetekende, verklaar hierbij dat de hierboven gespecificeerde uitrusting goedgekeurd is volgens de bovenstaande Richtlijn(en) en Standaard(en).

Je soussigné, confirme la conformité de l'équipement cité dans la présente à la / aux Directive(s) et Norme(s) ci-dessus
Ich, der/die Unterzeichnende, erkläre hiermit, dass das oben angegebene Gerät der/den oben angeführten Richtlinie(n) und Norm(en) entspricht.

Il sottoscritto dichiara che l'apparecchiatura di sopra specificata è conforme alle Direttive e agli Standard sopra riportati.

El abajo firmante declara por la presente que el equipo arriba especificado está en conformidad con la(s) directiva(s) y estándar(es) arriba mencionadas.

Eu, o abaixo-assinado, declaro que o equipamento anteriormente especificado está em conformidade com a(s) anterior(es) Directiva(s) e Norma(s)

Date • Data • Date • Datum • Data • Fecha • Data

13th May 2019

Signature • Handtekening • Signature • Unterschrift
Firma • Firma • Assinatura

Ashley Hooper

Full Name • Volledige naam • Nom et prénom • Vollständiger Name •
Nome completo • Nombre completo • Nome por extenso

Position • Functie • Fonction • Position • Qualifica • Posición • Função

Technical & Quality Manager



<http://www.buffalo-appliances.com/> 

CR904_UK_A5_v2_20190730