

# E3913i / E3914i Induction Ranges

## USER INSTRUCTIONS



**CAUTION - READ THESE INSTRUCTIONS BEFORE USING THIS APPLIANCE!**

- Section 1 – **GENERAL DESCRIPTION**
- Section 2 – **SAFETY and OPERATION**
- Section 3 – **COOKING HINTS**
- Section 4 – **INDUCTION ERROR CODES**
- Section 5 – **CLEANING and MAINTENANCE**
- Section 6 – **TROUBLESHOOTING**
- Section 7 – **SPECIFICATION**

This appliance has been UKCA/CE marked based on compliance with the relevant Electrical and Electromagnetic Compatibility (EMC) Regulations/Directives for the voltages stated on the data plate.

The appliance **MUST BE** installed by a competent person in compliance with the **INSTALLATION AND SERVICING INSTRUCTIONS** and National Regulations in force at the time.

UK regulations are listed on the front of the Installation and Servicing Instructions.

### **PREVENTATIVE MAINTENANCE CONTRACT**

To obtain maximum performance from this unit regular servicing of the appliance should be undertaken to ensure correct operation, it is functioning as intended, and safe to use. We recommend servicing in accordance with SFG20 Maintenance Schedules and as a minimum, after 2,500 hours of use, or annually, whichever comes first and that a maintenance contract be arranged with an appointed service contact. Visits may then be made at agreed intervals to carry out adjustments and repairs.

**WARNING - THE APPLIANCE MUST BE EARTHED.**

**WARNING - PERSONS WITH PACEMAKERS SHOULD CONSULT THEIR G.P. BEFORE OPERATING THIS APPLIANCE. THIS UNIT OPERATES AT 18 - 25KHz AND THIS MAY AFFECT OLDER TYPES OF PACEMAKER.**

**WARNING - USERS MUST ALSO BE AWARE THAT INDIVIDUALS FITTED WITH AN INSULIN PUMP SHOULD CONSULT THEIR INSULIN PUMP MANUFACTURE AND DOCTOR IF IN A CLOSE PROXIMITY TO THIS UNIT. THIS INDUCTION UNIT EMANATES AN 18 KHz TO 25 KHz OUTPUT THAT MAY AFFECT SOME TYPES OF INSULIN PUMPS.**

**ENSURE ALL POT/PAN BASES ARE FLAT AND CLEAN PRIOR TO USE.**

**THE AIR INTAKE FILTER MUST BE CLEANED REGULARLY TO REMOVE POTENTIAL OBSTRUCTIONS.**

Upon receipt of the User's Instruction manual, the installer should instruct the responsible person(s) of the correct operation and maintenance of the unit.



### **WEEE Directive Registration No. WEE/DC0059TT/PRO**

At end of unit life, dispose of appliance and any replacement parts in a safe manner, via a licenced waste handler.

Units are designed to be dismantled easily and recycling of all material is encouraged whenever practicable.

### **Falcon Foodservice Equipment**

#### **HEAD OFFICE AND WORKS**

Wallace View, Hillfoots Road, Stirling, FK9 5PY, Scotland.

Phone: 01786 455200

T100844 Ref. 8

## SECTION 1 - GENERAL DESCRIPTION

4 x 5kW, individually controlled, marked cooking zones on a glass-ceramic cooktop. Mounted upon 6.0kW single fan convection oven with 5 shelf positions.

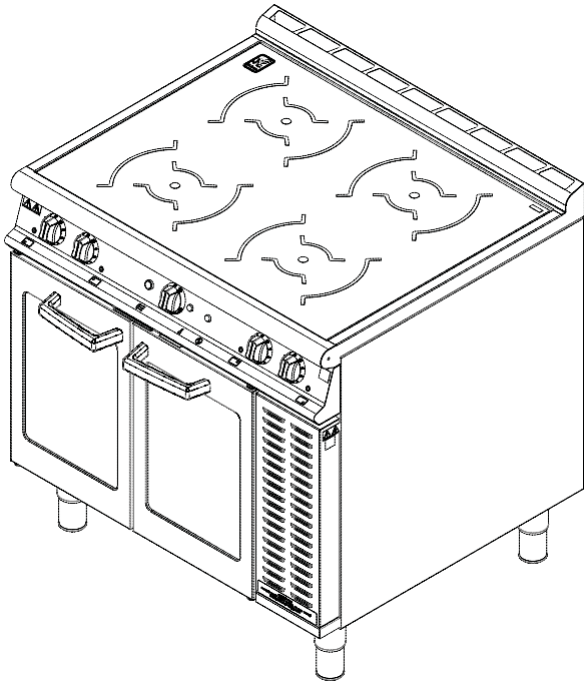

Figure 1

## SECTION 2 - SAFETY and OPERATION

**WARNING** - IF GLASS-CERAMIC TOP IS CRACKED OR BROKEN, IMMEDIATELY DISCONNECT APPLIANCE FROM POWER SUPPLY AND CONTACT YOUR SERVICE AGENT.



**WARNING** - PERSONS WITH PACEMAKERS SHOULD CONSULT THEIR G.P. BEFORE OPERATING THIS APPLIANCE. THIS UNIT OPERATES AT 18 - 25KHz AND THIS MAY AFFECT OLDER TYPES OF PACEMAKER.

**WARNING** - USERS MUST ALSO BE AWARE THAT INDIVIDUALS FITTED WITH AN INSULIN PUMP SHOULD CONSULT THEIR INSULIN PUMP MANUFACTURE AND DOCTOR IF IN A CLOSE PROXIMITY TO THIS UNIT. THIS INDUCTION UNIT EMANATES AN 18 KHz TO 25 KHz OUTPUT THAT MAY AFFECT SOME TYPES OF INSULIN PUMPS.

The air intake filter **MUST** be in position during operation and **MUST** be cleaned regularly.

**DO NOT** obstruct air filter entry below front of appliance or flue exit at top/ rear.

This unit must be installed by a suitably qualified person. A mains input connecting cable **is not supplied with unit**. A suitable cable should be provided by the installer, conforming to at least 6mm<sup>2</sup>, type H07RN-F.

**Use of proper pan type is essential for correct induction hob operation (Refer to Section 3).**

**Do not place any metal objects, such as kitchen utensils, cutlery, aluminium foil or plastic vessels upon the glass-ceramic hob.**

Items such as rings, watches, bracelets, etc. worn by the user could become hot when in close proximity to cooking zone. Do not place credit cards, etc. on glass-ceramic top as data could be wiped.

Never leave induction hob unsupervised when in use. The glass-ceramic top must **NOT** be used for storage. Do not place cloths etc. over appliance rear. This may impede flue outlet and cause overheating of appliance.

## SECTION 3 - OPERATION

### INDUCTION HOB

Use of correct pan type is essential for proper operation.

Suitable pans are those made with ferrous materials, ie, ferrous stainless steel, steel. Use a magnet to check, if magnet sticks to base, the pan should be OK to use.



**Warning – *this only tests function – not quality!***

Poor quality will reduce efficiency and performance.

Always place pans centrally upon cooking zone for optimum performance and safety.

Optimum pan diameter is **270mm**. Do not use pans of less than **120mm** diameter.

If a pan base is damaged or warped, ie concave or convex, discontinue use as this will seriously affect performance.

Each cooking zone is controlled by a marked, variable control from 1 (lowest) to 10 (highest). The ideal setting for simmering or fast boiling pans of varying size will quickly be established through experience.

Each control has a green LED indicator. When a cooking zone is switched on, the LED indicator will light and stay lit during heating/cooking. If pan is removed from zone, LED will flash approximately once per second to indicate cooking zone is still active, awaiting detection of a pan.

**After use, switch off cooking zones by returning control to OFF position. DO NOT rely on pan detector or safety features to isolate cooking zone.**

**Note: Positioning lines available for centralising pot(s).**

It is important that pots are magnetic or induction- approved.

A guide to the correct use of pans and cooking zones is provided on Pages 5 and 6.

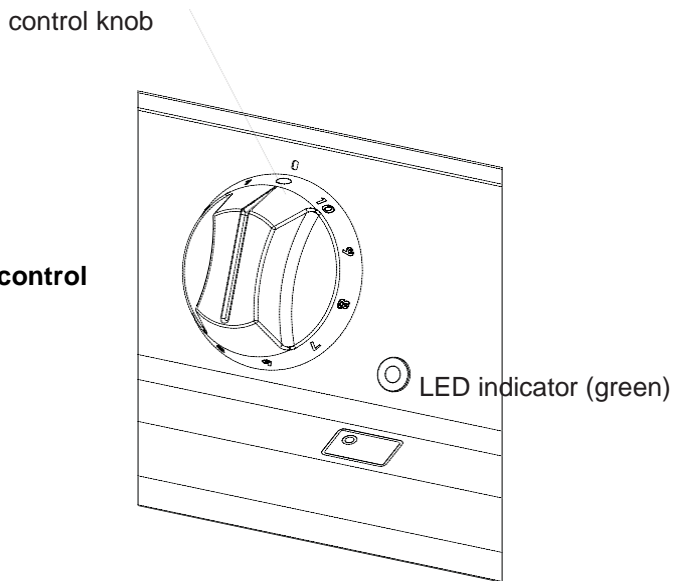

**Figure 2- Hob zone control**

**OVEN**

The oven is controlled by a thermostat. An amber neon, when lit, indicates that current is being supplied to the elements. This will go out when oven has reached selected temperature.

**Grid Shelves**

Two oven shelves are supplied. Five shelf positions are available. If two shelves are used at once, they should be spaced at least two runners apart, e.g. 1 – 3, 3 – 5 etc.

**Tray Size**

The oven accommodates 1 x 1 gastronorm trays (530 x 325mm) or other types up to 530 x 500mm.

Trays and dishes should always be located centrally on the shelves.

**Pre-Heating Time**

Allow at least 45 mins from switching on from cold, irrespective of temperature setting.

Insert food items quickly and close the doors firmly.

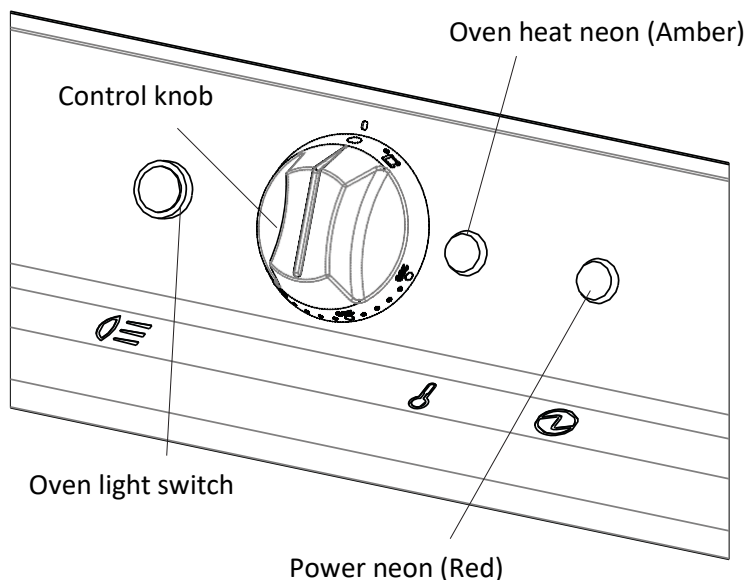

**Figure 3 - Oven control**

## Oven Light

Push and hold switch to view items while cooking.

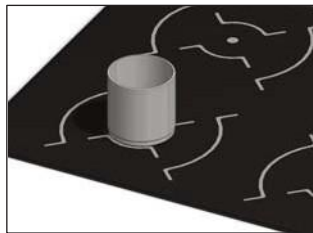

**Figure 4. Zone will not operate**

**Ø110mm pan.** If inner circle markings can be seen, pan is too small. Detection will prevent cooking using this size of pan

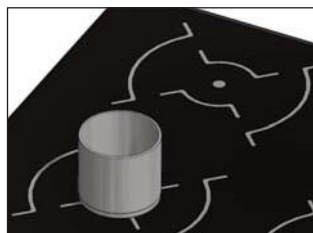

**Figure 5. Zone will operate**

**Ø120mm pan.** Ideal, positioned centrally. Inner circle cannot be seen. **Note:** Positioning lines are available for central positioning of pan

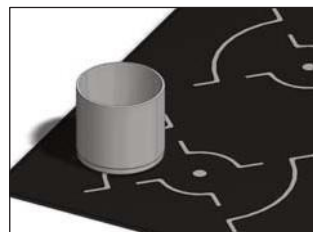

**Figure 6. Zone will not operate**

**Ø120mm pan.** Ideal, but positioned incorrectly. Only half the pan contents will cook as outer circle markings have been compromised.

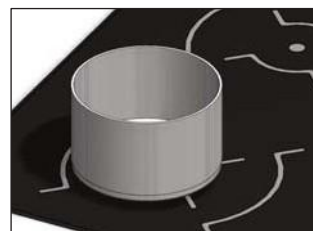

**Figure 7. Zone will operate, however**

**Ø180mm pan.** Ideal for cooking. Although pot is positioned incorrectly, whole pan area will cook. Outer circle markings have not been compromised.

**(THIS IS NOT RECOMMENDED PRACTICE)**

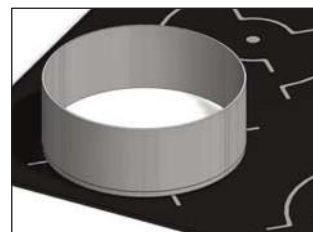

**Figure 8. Zone will operate.**

**Ø270mm pan.** Ideal for cooking, positioned in centrally.

**Note .** Positioning available to centralize pot.

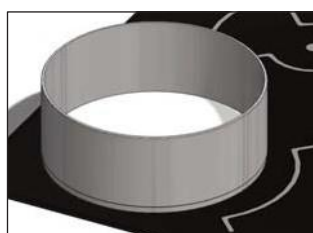

**Figure 9. Zone will operate- however:**

**Ø270mm pan.** Ideal for cooking but positioned incorrectly. Only three quarters of pan will cook as outer circle markings have been compromised.

## POT TYPE and CONDITION GUIDE

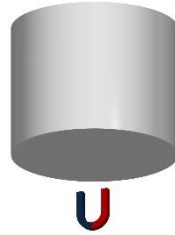
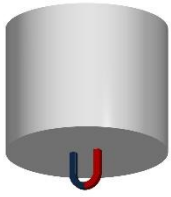

Figures 10 and 11

**Note:** A suitable pan is made of ferrous material. This being magnetic, it will react to the induction field. Ensure pots are magnetic or induction approved.

If pan base is damaged or warped, ie concave or convex, discontinue use or replace as this could seriously affect performance, refer to diagrams below.



**Figure 12** Pan base is FLAT and ideal for cooking.

**Note:** Pans should be kept clean and free from damage. Dirty, damaged pans effect efficiency.



**Figure 13** Pan base is bowed out and is NOT FLAT. Unit efficiency will be dramatically reduced during cooking. It may not even be detected.

**Note:** This is also liable to happen if pans are damaged, e.g. large dents



**Figure 14** Pot base is bowed inward and is NOT FLAT; The unit efficiency will be dramatically reduced during cooking. It may not even be detected.

**Note:** This is also liable to happen if pans are damaged, e.g. large dents.



**Figure 15** Excessive food spillage stuck to pan base will impinge balance of pan. One side of utensil will be further away from induction field than another. This may reduce efficiency and will cook one side of pan faster. Keep pans clean to ensure efficient cooking.



The three instances marked thus will cause the generator to overheat and cut out.

If this occurs, turn off power. The generator will self-reset when temperature goes down.

## SECTION 3 - COOKING HINTS

1. Before use, ensure hob surface is clean, dry and free of grease. Remove any burnt on food debris.
2. Familiarise yourself with cooking area and control settings.
3. Each cooking zone has a power capacity of 5kW.
4. Each zone is governed by individual energy regulator.
5. Control setting is from 1 to 10. (1 - lowest setting, 10 - highest).
6. Boiling, steaming, poaching, stewing, pot roasting, deep and shallow frying can be achieved on the hob.
7. Ferritic cooking vessels must be used.
8. To boil liquid, follow this procedure:  
Fill and position pan centrally within cooking zone. Turn appropriate switch dial to 10.  
When boiling occurs, reduce setting and continue to cook by simmering.
9. The lower setting is dependent on amount and density of liquid and also starch content.
10. Skill is required to control simmering and the ability to select a corresponding temperature setting will improve with practice.
11. Any spillage should be cleaned from hob surface as soon as practically possible.



**Failure to clean filter regularly may cause problems that will not be covered by warranty.**

**The air intake filter MUST ALWAYS be in place during operation.**

Wipe glass-ceramic hob clean using a damp cloth and warm, soapy water. For heavy stains, use a scraper while cooking zone is still warm. Wipe down with a damp cloth when zone is cool.

### **Chef's Tips**

Always pre-heat oven to desired temperature. Use appropriate trays and NEVER overload oven. Place food centrally upon the shelves.

Avoid opening oven doors during cooking process.

If removing food from oven, ensure doors are fully open. Cooking times are dependant upon the following:

Pre-heat temperature

Food temperature (*e.g. frozen, chilled or ambient*)

Shelf load / Oven load / Size and weight of food

## SECTION 4 - TROUBLESHOOTING

### SUPPLY PROTECTION DEVICE

The appliance is fitted with a miniature circuit breaker (MCB) as additional protection against over current. If unit fails to operate or show any operational indicators, Follow details in Error Code Table before calling a service engineer. The symptoms may indicate a failed induction generator

## SECTION 5 - ERROR CODES

DO NOT remove or attempt to repair or replace ANY part or parts of this appliance other than the air intake filter.

If an error occurs within the unit, the control panel LEDs will flash to indicate an error code.

The error code list that follows will help identify the faulty component.

In the "action by user" list, you should follow the action listed, **before contacting a Service Engineer.**

There are two different error types:

- Generator errors (E1)
- Digital control errors(E2)

**Generator errors** are faults detected by the generator, faults can be detected according to the duration and frequency of the green light blinking. When using potentiometer knob, the green lamp lights one time long and then short regular flashes

For example:

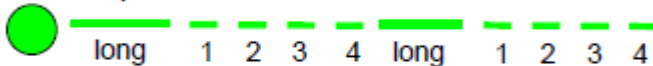

When using LIN knob, the green lamp lights one time long, one medium flash (E1) and then short regular flashes. The number of these short flashes is the error number. This pattern is constantly repeated.

For example: error code E1 - 04 from the generator using LIN knob:

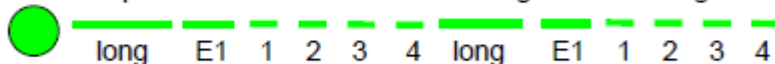

**Digital control errors** are faults from the digital controls. On the display appears "E2", the green lamp lights two times long and then short regular flashes. The number of these short error flashes is the error number. The pattern is constantly repeated.

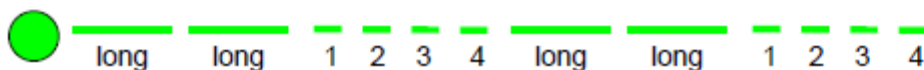

**Note:** Most faults can be rectified by simply switching the unit off for 10 seconds. After this time, turn the power back on at mains supply. If the fault continues to occur after this action then please refer to the table. The following codes can be assessed by the user; any others will require a service engineer.



<b>Error</b>	<b>Name</b>	<b>Cause</b>	<b>Corrective action</b>
E1-04	Cooking zone temperature too high.	Pan empty	Remove pan, switch off Appliance and wait a couple of minutes for the appliance to cool
E1-06	Internal Temperature too high	Air routes blocked.	Switch off appliance, clean air units
E1-07	Coil Temperature.	Coil temperature too high.	Remove pan, switch off appliance for a couple of minutes.
E1-15	Empty Pan protection.	Empty Pan.	Remove pan, switch off and wait for a couple of minutes until the cooking field has cooled down.

## SECTION 6 - CLEANING and MAINTENANCE

**It is important to clean air intake filter regularly.**

The filter is located below body of appliance at front and RH side. It can be removed by sliding out of front. Clean using hot, soapy water and re-fit after drying. (Refer to Figure 5).

### CLEANING THE APPLIANCE

#### General

BEFORE ANY CLEANING OPERATION, ISOLATE ELECTRICITY AT MAIN SWITCH. THE APPLIANCE MUST NEVER BE CLEANED WITH A JET OF WATER OR BE STEAM CLEANED.

Surfaces are easier to clean if spillage is removed before it becomes burnt on. It is advisable to clean unit daily, after use.

#### Stainless Steel Surfaces

These surfaces should be cleaned with hot water and detergent then dried and polished with a soft cloth.

Cleaning agents containing bleach, abrasives or caustic chemicals will damage or stain the stainless steel surfaces and must not be used.

#### Vitreous Enamel Surfaces

Approved cleaning agents which bear the Vitreous Enamel Development Centre (VEDC) mark are recommended.

Wipe enamelled surfaces clean while still warm. Use a soft cloth and hot soapy water. Badly stained, removable parts should be soaked in hot water with an approved detergent.

If parts are not able to be removed, the application of warm water with approved detergent using nylon or scotch cleaning pads will provide good results.

#### Ceran-glass Hob

Clean glass with hot soapy water and a soft cloth. Do NOT use metal scrapers.

### MAINTENANCE

#### Oven Door Catch

Lubricate door catch occasionally. Push down roller and apply high melting point lubrication inside the catch and onto the roller itself.

If there are issues with closing of the door, try adjusting the catch (**Fig 16**). Use your hands or an appropriate implement to push down on the roller **1** as shown. Whilst holding it down, turn it right **2** to adjust it down, or left **3** to adjust it up as shown.

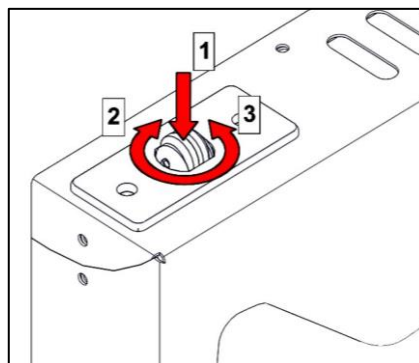

**Figure 16 - Door catch adjustment**

## SERVICE INFORMATION

This unit carries an extensive mainland UK warranty. The warranty is in addition to and does not change your statutory or legal rights.

The warranty policy can be found on our website which details the conditions of the warranty and the exclusions.

<https://www.falconfoodservice.com/info-centre/policy>



Service calls to equipment under warranty will be carried out in accordance with the conditions of sale.

Warranty calls can be made between 8:30 am and 5:00 pm weekdays only.

To ensure your warranty enquiry is handled as efficiently as possible, ensure you have the following appliance information prior to calling us:

1. Model number – found on data plate
2. Serial number – found on data plate
3. Brief description of the issue

To contact Falcon for a warranty issue dial (UK only) 01786 455 200 and select Warranty Issues from the menu.

## SECTION 7 - SPECIFICATION

### E3913i Range

Dimensions ( <i>w x d x h mm</i> )	900 x 770 x 890
Weight ( <i>unpacked</i> )	140kg
Weight ( <i>unpacked</i> )	159kg
Electrical connection	400V 3N~
Individual cooking zone rating	3.5kW ( x 4)
Oven rating	6kW
Total rating	20kW
Amps per phase L1	29A
Amps per phase L2	29A
Amps per phase L3	29A

### E3914i Range

Dimensions ( <i>w x d x d mm</i> )	900 x 770 x 890
Weight ( <i>unpacked</i> )	140kg
Weight ( <i>unpacked</i> )	159kg
Electrical connection	400V 3N~
Individual cooking zone rating	5kW ( x 4)
Oven rating	6kW
Total rating	26kW
Amps per phase L1	38A
Amps per phase L2	38A
Amps per phase L3	38A

### Key to unit symbols



Non-ionizing, electro-magnetic radiation.



Dangerous voltage



Equipotentiality