

ECLIPSE 2W3-W

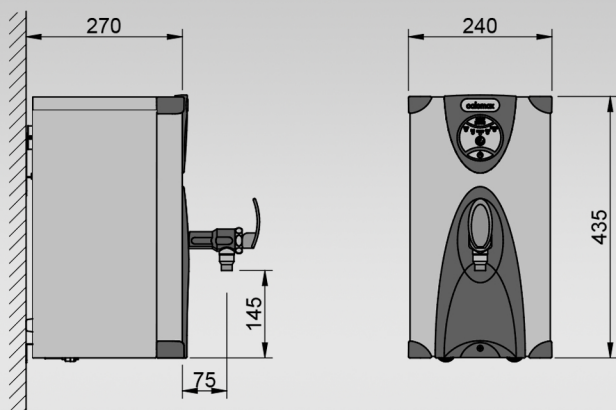

Key Features:

- UK designed and made
- 3L rapid draw off
- Temperature controlled between 96°C and 97°C
- Easy install and service features - removable front panel
- Energy-saving "eco" button which reduces the volume of boiling water by 50% at "off peak" times of demand
- Antimicrobial protection in the tap handle and spill tray
- Clear and unambiguous self-diagnostic display panel
- Integral scale-inhibitor technology
- Extended 2-year warranty
- No steam emissions
- Discrete on/off switch incorporated into moulding
- Competitively priced
- Cool-to-touch outer casing
- Push-fit and compression adapter included to simplify installation



SIZE	REF	CASING	RATING	CAPACITY (including initial draw-off)	DIMENSIONS (W x D x H)
3 LITRE	2W3-W	WHITE	2kW	23 LITRES PER HOUR	240 x 270 x 435