



EVOLUTIONSERIES

INSTALLATION AND OPERATION MANUAL

GAS GRIDDLE TOASTER

G55T

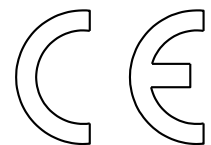


Date Purchased _____

Serial Number _____

Dealer _____

Service Provider _____



For use in GB & IE

228001-9

MANUFACTURED BY

Moffat Limited

Rolleston 7675
New Zealand

INTERNATIONAL CONTACTS

AUSTRALIA

Moffat Pty Limited

Web: www.moffat.com.au
E.Mail: vsales@moffat.com.au
Main Office: (tel) +61 (03) 9518 3888
(fax) +61 (03) 9518 3838
Service: (tel): 1800 622 216
Spares: (tel): 1800 337 963
Customer Service: (tel): 1800 335 315
(fax): 1800 350 281

CANADA

Serve Canada

Web: www.servecanada.com
E.Mail: info@servecanada.com
Sales: (tel): 800 551 8795 (Toll Free)
Service: (tel): 800 263 1455 (Toll Free)

NEW ZEALAND

Moffat Limited

Web: www.moffat.co.nz
E.Mail: sales@moffat.co.nz
Main Office: (tel): 0800 663328

UNITED KINGDOM

Blue Seal

Web: www.blue-seal.co.uk
E.Mail: sales@blue-seal.co.uk
Sales: (tel): +44 121 327 5575
(fax): +44 121 327 9711
Spares: (tel): +44 121 322 6640
(fax): +44 121 327 9201
Service: (tel): +44 121 322 6644
(fax): +44 121 327 6257

UNITED STATES

Moffat

Web: www.moffat.com
Sales: (tel): 800 551 8795 (Toll Free)
(tel): +1 336 661 1556
(fax): +1 336 661 9546
Service: (tel): 800 858 4477 (Toll Free)
(tel): +1 336 661 1556
(fax): +1 336 661 1660

REST OF WORLD

Moffat Limited

Web: www.moffat.co.nz
E.Mail: export@moffat.co.nz

The reproduction or copying of any part of this manual by any means whatsoever is strictly forbidden unless authorized previously in writing by the manufacturer.

In line with policy to continually develop and improve its products, Moffat Ltd. reserves the right to change the specifications and design without prior notice.

Blue Seal Gas Griddle Toaster**G55T**

Introduction	2
Specifications	3
Model Numbers Covered in this Specification	
General	
Optional Accessories	
Gas Supply Requirements	
Gas Connection	
Dimensions	5
Weight (Nett)	
Installation	6
Installation Requirements	
Unpacking	
Location	
Clearances	
Assembly	
Gas Connection	
Commissioning	
Operation.....	9
Operation Guide	
Description of Controls	
Lighting Pilot Burners	
Using Griddle	
Using Toaster	
Cleaning and Maintenance.....	11
General	
After Each Use	
Daily Cleaning	
Weekly Cleaning	
Periodic Maintenance	
Fault Finding.....	14
Gas Conversion and Specifications	15
Conversion Procedure	
Gas Specifications	
Replacement Parts List	19

Introduction

We are confident that you will be delighted with your BLUE SEAL GAS GRIDDLE TOASTER and it will become a most valued appliance in your commercial kitchen.

To ensure you receive the utmost benefit from your new Blue Seal Gas Griddle Toaster, there are two important things you can do.

Firstly:

Please read the instruction book carefully and follow directions given. The time taken will be well spent.

Secondly:

If you are unsure of any aspect of the installation, instructions or performance of your appliance, contact your BLUE SEAL dealer promptly. In many cases a phone call could answer your question.

CE Only:

These instructions are only valid if the country code appears on appliance. If code does not appear on appliance, refer to supplier of this appliance to obtain technical instructions for adapting appliance to conditions for use in that country.



Warning

IMPROPER INSTALLATION, ADJUSTMENT, ALTERATION, SERVICE OR MAINTENANCE CAN CAUSE PROPERTY DAMAGE, INJURY OR DEATH. READ THE INSTALLATION, OPERATING AND MAINTENANCE INSTRUCTIONS THOROUGHLY BEFORE INSTALLING OR SERVICING THIS APPLIANCE.



Warning

INSTRUCTIONS TO BE FOLLOWED IN THE EVENT USER SMELLS GAS, ARE TO BE POSTED IN A PROMINENT LOCATION. THIS INFORMATION SHALL BE OBTAINED BY CONSULTING WITH LOCAL GAS SUPPLIER.



Warning

GREAT CARE MUST BE TAKEN BY THE OPERATOR TO USE EQUIPMENT SAFELY TO GUARD IT AGAINST RISK OF FIRE.

- **THE APPLIANCE MUST NOT BE LEFT ON UNATTENDED.**
- **IT IS RECOMMENDED THAT A REGULAR INSPECTION IS MADE BY A COMPETENT SERVICE PERSON TO ENSURE CORRECT AND SAFE OPERATION OF YOUR APPLIANCE IS MAINTAINED.**
- **DO NOT STORE OR USE GASOLINE OR OTHER FLAMMABLE VAPOURS OR LIQUIDS IN THE VICINITY OF THIS OR ANY OTHER APPLIANCE.**
- **DO NOT SPRAY AEROSOLS IN THE VICINITY OF THIS APPLIANCE WHILE IT IS IN OPERATION.**



Caution

- **This appliance is for professional use and is only to be used by qualified persons.**
- **Only authorised service persons are to carry out installation, servicing or gas conversion operations.**
- **Components having adjustments protected (e.g. paint sealed) by manufacturer should not be adjusted by the user / operator.**
- **DO NOT operate appliance without legs supplied, fitted.**

Model Numbers covered in this Specification

G55T Gas Griddle Toaster

General

A commercial heavy-duty gas fired griddle toaster, having two tubular burners heating a griddle plate from underneath and providing toasting heat for the toasting rack below.

Burners are operated by individual control valves and are provided with a piezo ignition permanent pilot incorporating a thermocouple flame failure control.

Optional Accessories

This appliance can be fitted with the following optional accessories, (refer to 'Replacement Parts List' for details).

- Plinth Kit.

Gas Supply Requirements

- Australia:

	Natural Gas	LP Gas (Propane)
Input Rating (N.H.G.C.)	42 MJ/hr	42 MJ/hr
Supply Pressure	1.13 - 3.40 kPa	2.75 - 4.50 kPa
Burner Operating Pressure	1.00 kPa (*)	2.50 kPa (*)
Gas Connection	$\frac{1}{2}$ " BSP Male	

- New Zealand:

	Natural Gas	LP Gas
Input Rating (N.H.G.C.)	42 MJ/hr	42 MJ/hr
Supply Pressure	1.13 - 3.40 kPa	2.75 - 4.50 kPa
Burner Operating Pressure	1.00 kPa (*)	2.50 kPa (*)
Gas Connection	$\frac{1}{2}$ " BSP Male	

- UK Only:

Category: **II_{2H3P} (20, 30 / 37).**
 Flue Type: **A₁.**

		Natural Gas (G20)	Propane (G31)
Heat Input (nett)	Nominal	11.0 kW	11.0 kW
	Reduced	6.0 kW	5.6 kW
Gas Rate (nett)	Nominal	1.16 m ³ /hr	0.85 kg/hr
	Reduced	0.63 m ³ /hr	0.44 kg/hr
Supply Pressure		20 mbar	37 mbar
Burner Operating Pressure		10 mbar (*)	26 mbar (*)
Gas Connection		$\frac{1}{2}$ " BSP Male	

NOTE:

- * - Measure burner operating pressure at manifold test point with **both burners** operating at full setting. Operating pressure is ex-factory set, through appliance regulator and is not to be adjusted, apart from when converting between gases, if required. (Refer to 'Gas Conversion' section for details).

Specifications

- All Other Markets:

	Natural Gas	Town Gas (**)
Input Rating (N.H.G.C.)	42MJ/hr	42MJ/hr
Supply Pressure	1.13 - 3.40kPa	0.75 - 1.50kPa
Burner Operating Pressure (*)	1.0kPa (*)	0.63kPa (*)
Gas Connection	$\frac{1}{2}$ " BSP Male	

	LP Gas (Propane)	Butane
Input Rating (N.H.G.C.)	42MJ/hr	42MJ/hr
Supply Pressure	2.75 - 4.50kPa	2.75 - 4.50kPa
Burner Operating Pressure (*)	2.5kPa (*)	2.5kPa (*)
Gas Connection	$\frac{1}{2}$ " BSP Male	

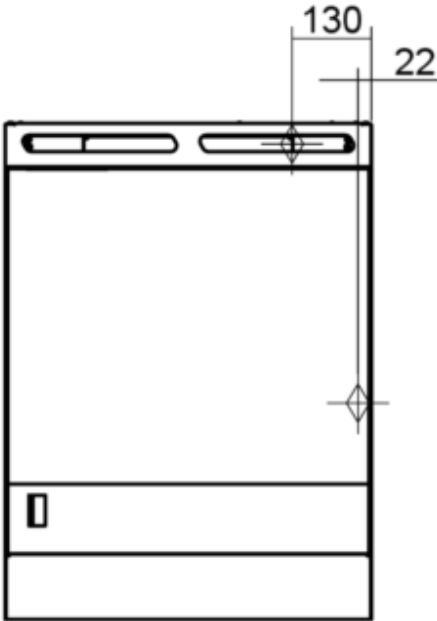
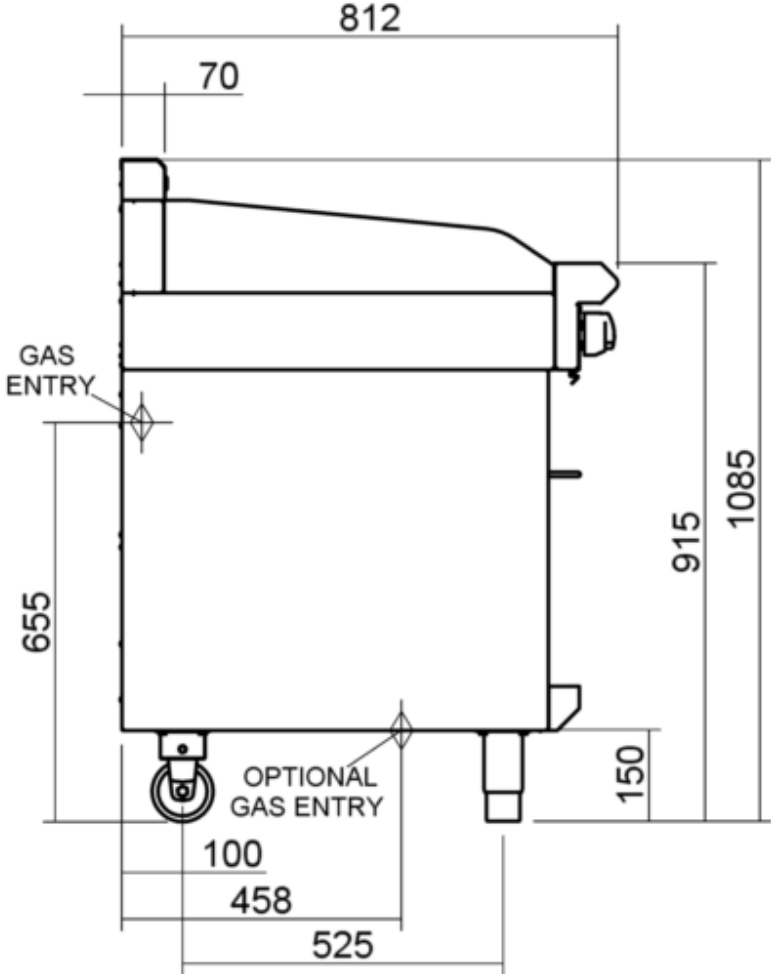
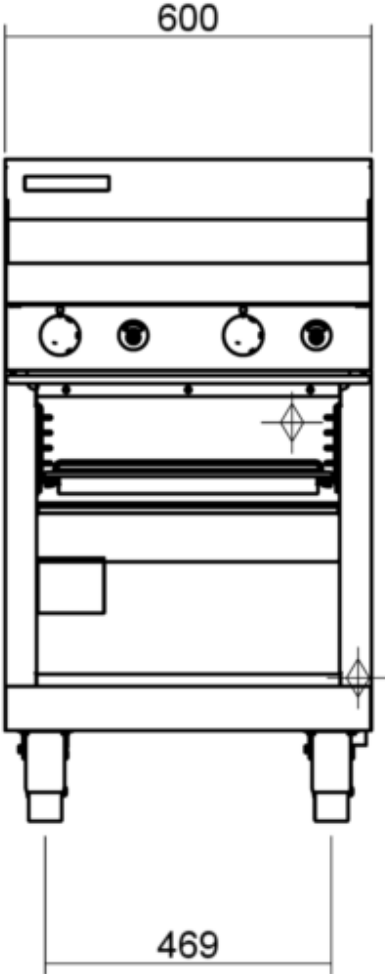
(*) NOTE:

- Measure Burner operating pressure at manifold test point with two burners operating at 'High Flame' setting.
- NAT, LPG & Butane Only - Operating pressure is ex-factory set and is not to be adjusted, unless when converting between gases, if required.
- TOWN GAS Only - Adjust burner operating pressure using adjustable gas regulator supplied.
- Refer to 'Gas Conversion and Specifications' section in this manual for further details.

Gas Connection

Gas supply connection point is located 130mm from right hand side of appliance, 32mm from rear, 655mm from floor and is entered from beneath appliance. An optional underside connection is available.

G55T Gas Griddle Toaster



◆ Gas Connection Point.

Weight (Nett)

G55T 120kg

Installation

Installation Requirements

NOTE:

- It is most important that this appliance is installed correctly and that operation is correct before use. Installation shall comply with local, gas, health and safety requirements.
- This appliance shall be installed with sufficient ventilation to prevent occurrence of unacceptable concentrations of health harmful substances in the room, appliance is installed in.

Blue Seal Griddle Toasters are designed to provide years of satisfactory service and correct installation is essential to achieve the best performance, efficiency and trouble-free operation.

This appliance must be installed in accordance with National installation codes and in addition, in accordance with relevant National / Local codes covering gas and fire safety.

AUSTRALIA:	- AS5601	- Gas Installations.
NEW ZEALAND:	- NZS5261	- Gas Installation.
UNITED KINGDOM:	- Gas Safety (Installation & Use) Regulations 1998.	
	- BS6173	- Installation of Catering Appliances.
	- BS5440	- 1 & 2 Installation Flueing & Ventilation.
IRELAND:	- IS 820	- Non - Domestic Gas Installations.

Installations must be carried out by qualified service persons only. Failure to install equipment to relevant codes and manufacturers specifications shown in this section will void the warranty.

Components having adjustments protected (e.g. paint sealed) by manufacturer, are only to be adjusted by a qualified service person. They are not to be adjusted by the installation person.

Unpacking

- Remove all packaging and transit protection from appliance including all protective plastic coating from exterior stainless steel panels.
- Check equipment and parts for damage. Report any damage immediately to carrier and distributor.
- Report any deficiencies to distributor who supplied appliance.
- Check available gas supply is correct to as shown on rating plate located on R/H inner side panel.
- Check the following parts have been supplied with appliance:

Enamelled Crumb Tray	1
Toasting Rack	1
Toasting Rack Tray (St/Steel)	1
Grease Drawer	1
Adjustable Legs	4
Gas Regulator	1
Alternate Gas Conversion Kit	1

Location

1. Installation must allow for sufficient flow of fresh air for combustion air supply.

Combustion Air Requirements:	
Natural Gas (G20)	10 m³/hr
LPG (G31)	9 m³/hr
Town Gas	10 m³/hr

2. Installation must include adequate ventilation means, to prevent dangerous build up of combustion products.
3. Position appliance in its approximate working position.
4. All air for burner combustion is supplied from beneath appliance. Legs must always be fitted and no obstructions placed beneath or around base of appliance, as obstructions will cause incorrect operation and / or failure of appliance.

5. Components having adjustments protected (e.g. paint sealed) by manufacturer are only allowed to be adjusted by an Qualified service agent. They are not to be adjusted by the installation person.

NOTE: Do not obstruct or block the appliances flue. Never directly connect a ventilation system to the appliance flue outlet.

Clearances

NOTE: Only non-combustible materials can be used in close proximity to this appliance.

Any gas burning appliance requires adequate clearance and ventilation for optimum and trouble-free operation. The following minimum installation clearances are to be adhered to:

	Combustible Surface	Non Combustible Surface
Left / Right hand side	50mm	0mm
Rear	50mm	0mm

Assembly

G55T model only

This model is delivered completely assembled. No further assembly is required.

NOTE:

- This appliance is fitted with adjustable feet to enable appliance to be positioned securely and level. This should be carried out on completion of the gas connection. Refer to 'Gas Connection' section below.

Optional Accessories (Refer to Replacement Parts List)

- Plinth Kit. For installation details, refer to instructions supplied with each kit.

1. Check all feet (castors) are securely fitted.
2. Adjust feet to make gas griddle toaster steady and level.

Gas Connection

NOTE: ALL GAS FITTING MUST ONLY BE CARRIED OUT BY A QUALIFIED SERVICE PERSON.

1. Blue Seal Gas Griddle Toasters do not require an electrical connection, as they function totally on the gas supply only.
2. It is essential that gas supply is correct for appliance being installed and that adequate supply pressure and volume are available. The following checks should be made before installation:
 - a. **Gas Type** the appliance has been supplied for, is shown on a coloured sticker located above gas connection and on rating plate. Check this is correct for gas supply appliance is being installed for. Gas conversion procedure is detailed in this manual.
 - b. **Supply Pressure** required for this appliance is shown in 'Specifications' Section of this manual. Check gas supply to ensure adequate supply pressure exists.
 - c. **Input Rate** of this appliance is stated on Rating Plate and in 'Specifications' section of this manual. Input rate should be checked against available supply line capacity. **Particular note should be taken if appliance is being added to an existing installation.**



Fig 1

NOTE: It is important that adequately sized piping runs directly to connection joint on griddle toaster with as few tees and elbows as possible to give maximum supply volume.

Installation

- Fit gas regulator supplied, into gas supply line as close to appliance as possible.

NOTE: Gas pressure regulator provided with this appliance is convertible between Natural Gas and LPG as shown in 'Gas Conversion Section' in this manual.

Ensure regulator is converted to correct gas type that appliance will operate on.

Regulator outlet pressure is fixed ex-factory for gas type that regulator is converted to and it is NOT to be adjusted.

Regulator connections are $\frac{1}{2}$ " BSP female.

Connection to appliance is $\frac{1}{2}$ " BSP male.

(Refer to 'Specifications' section for gas supply location dimensions).

NOTE: A Manual Isolation Valve must be fitted to individual appliance supply line.

- Correctly locate griddle toaster into its final operating position and using a spirit level, adjust legs so that appliance is level and at the correct height.
- Connect gas supply to appliance. A suitable jointing compound which resists breakdown action of LPG must be used on every gas line connection, unless compression fittings are used.
- Check all gas connections for leakages using soapy water or other gas detecting equipment.



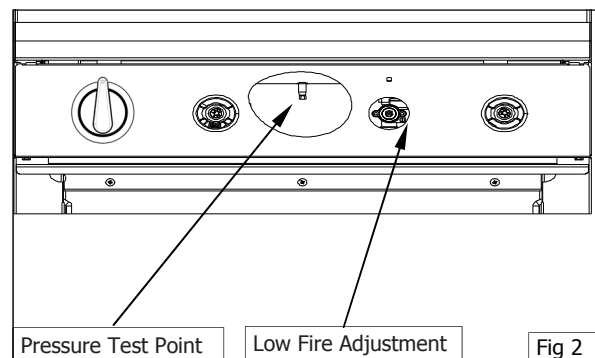
Warning

DO NOT USE A NAKED FLAME TO CHECK FOR GAS LEAKAGES.

- Check gas operating pressure is as shown in 'Specifications' section.

NOTE: Operating pressure to be measured at manifold pressure test point and with all burners operating at 'High Flame' setting.

- Verify operating pressure remains correct.



Commissioning

- Before leaving new installation;
 - Check the following functions in accordance with operating instructions specified in 'Operation' section of this manual.
 - Light the Pilot Burner.
 - Light the Main Burners.
 - Check the Low Fire burner operation.
 - Check the High Fire burner operation.
 - Ensure operator has been instructed in areas of correct lighting, operation, and shutdown procedure for appliance.
- This manual must be kept by the owner for future reference, and a record of **Date of Purchase**, **Date of Installation** and **Serial Number of Appliance** recorded and kept with this manual. **(These details can be found on Rating Plate attached to R/H inner side panel (refer to 'Gas Connection' section)).**

NOTE: If for some reason it is not possible to get appliance to operate correctly, shut 'Off' gas supply and contact supplier of this appliance.

Operation Guide

 **Caution**

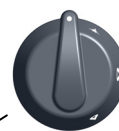
- **This appliance is for professional use and is only to be used by qualified persons.**
- **Only authorised service persons are to carry out installation, servicing or gas conversion operations.**
- **Components having adjustments protected (e.g. paint sealed) by the manufacturer should not be adjusted by the user / operator.**

1. Blue Seal Gas Griddle Toasters have been designed to provide simplicity of operation and 100% safety protection.
2. Improper operation is almost impossible, however bad operation practices can reduce the life of the appliance and produce a poor quality product. To use this gas griddle toaster correctly please read the following sections carefully before use.
 - Lighting Pilot Burners.
 - Using Griddle.
 - Using Toaster.

Description of Controls

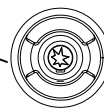


Fig 3



Gas Control Knobs

- OFF Position
- ☆ PILOT Burner
- △ HIGH Flame
- △ LOW Flame



Piezo Igniters

Ignites the Pilot Burners.

Operation

Lighting Pilot Burners

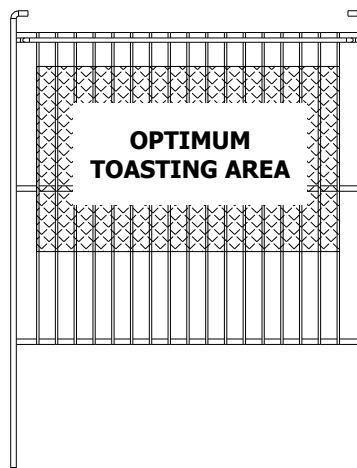
1. Depress gas control knob and rotate anti-clockwise to 'PILOT' position.
2. With control knob depressed, press piezo ignition button on front control panel until pilot burner ignites. Pilot ignition can be viewed through openings in control panel.
3. Hold in gas control knob for approximately 10 seconds, then release. Pilot burner should remain alight. If not repeat Items 1 to 3.
4. Repeat Items 1 to 3 to light second pilot burner.
5. Rotate gas control knob anti-clockwise to first stop for 'FULL' flame.
6. Depress and rotate gas control knob fully anti-clockwise for 'LOW' flame.

Using Griddle

1. Light pilot burners as shown above.
2. If starting from a cold start, turn gas controls to 'FULL' flame position and allow griddle plate to preheat for 10 minutes.
3. Place product to be cooked onto griddle plate.
4. For intermediate heat, position gas control knob between 'HIGH' and 'LOW' positions to achieve desired heat.
5. During idle periods, burners can be turned down to maintain an appropriate griddle plate temperature or gas controls can be set to 'PILOT' position as required.

Using Toaster

1. Light pilot burners as shown above.
2. If starting from cold, set burners to 'FULL' flame position and allow 5 minutes preheat before commencing toasting.
3. Adjust rack position to desired height.
4. Place product on rack to toast.
5. Best toasting results are achieved using shaded area of toast rack as per diagram below.
6. With main burners alight, individually controlled burners can be operated to suit food quantity requirements.
7. Each burner is operated by an 'OFF' / 'PILOT' / 'HIGH' / 'LOW' gas control. 'HIGH' position is recommended for most grilling, cheese melting functions and 'LOW' position for a reduced heat setting.



IMPORTANT:

Should any abnormal operation like;

- ignition problems,
- abnormal burner flame,
- burner control problems,
- partial or full loss of burner flame in normal operation, be noticed, appliance requires **IMMEDIATE** service by a qualified service person and should not be used until a service is carried out.

General



Caution

Always turn 'Off' gas supply before cleaning.

This appliance is not water proof.

Do not use water jet spray to clean interior or exterior of this appliance.

Clean griddle toaster regularly. A clean appliance looks better, will last longer and will perform better. Carbonised grease on surface or on griddle plate will hinder transfer of heat from cooking surface to food. This will result in loss of cooking efficiency.

NOTE: Each griddle toaster option can be supplied with a scraper tool and a pack of blades for cleaning the griddle surface. These are not supplied as standard and have to be purchased separately. Refer to 'Replacement Parts List' at rear of this manual.



Warning

THE BLADES FITTED TO THE SCRAPER TOOL ARE EXTREMELY SHARP AND ARE TO BE USED WITH CARE.

DO NOT use water on griddle plate while this item is still hot as warping and cracking may occur. Allow griddle plate to cool down before cleaning.

NOTE:

- DO NOT use abrasive detergents, strong solvents or caustic detergents as they could corrode or damage griddle toaster.
- In order to prevent forming of rust on griddle plate (Steel Plate), ensure that any detergent or cleaning material has been completely removed after each cleaning. Appliance should be switched 'On' briefly to ensure griddle plate becomes dry. Oil or grease should be spread over griddle surface to form a thin protective greasy film.

To keep your griddle clean and operating at peak efficiency, follow procedures shown below:-

After Each Use



Caution

Always ensure that even pressure is applied over whole surface of scraper tool when using on flat surface of griddle, to prevent scoring of griddle surface.

NEVER bang sharp edge of scraper tool on flat surface of griddle as this will damage griddle and invalidate the warranty.

1. Clean griddle with scraper tool to remove any food debris.
2. Always change scraper tool blades regularly to ensure scraper tool works efficiently and prevents damage to griddle plate surface.

Cleaning and Maintenance

Daily Cleaning

1. Crumb tray / grease drawer should be checked and emptied frequently to prevent overflow and spillage. Remove grease drawer while still warm so that grease is in a liquid state. Empty any grease from drawer and wash thoroughly in same manner as any cooking utensil.
2. Remove crumb tray and empty out contents. Wash thoroughly in same manner as any cooking utensil.
3. Thoroughly clean splash back, interior and exterior surfaces of griddle toaster with hot water, a detergent solution and a soft scrubbing brush.
4. Brush griddle surface with a soft bristled brush. Any carbon deposits should be removed using a scraper tool followed by wiping with a cloth to prevent accumulation of food deposits.
5. Dry griddle toaster thoroughly with a dry cloth and polish with a soft dry cloth.

Weekly Cleaning

NOTE:

- If griddle toaster usage is very high, we recommend weekly cleaning procedure is carried out on a more frequent basis.
- Ensure that protective gloves are worn during cleaning.
- DO NOT use harsh abrasive detergents, strong solvents or caustic detergents as they will damage griddle toaster and burners.
- DO NOT use water on griddle plate while it is still hot as warping may occur. Allow these items to cool before cleaning.

Griddle Plate

NOTE: To prevent rust forming on griddle plate, ensure that all detergent and cleaning material has been entirely removed after each cleaning process. Appliance should be switched 'On' briefly to ensure griddle plate becomes dry. Oil or grease should be spread over griddle surface in order to form a thin protective greasy film.

- a. Remove and clean grease collection drawer frequently to prevent over spills.
- b. Remove crumb tray frequently to prevent overflowing crumb tray.
- c. Clean griddle surface thoroughly with a scraper tool or a wire brush. If necessary use a griddle stone or a scotch bright pad on griddle surface to remove stubborn or accumulated carbon deposits.
- d. Occasionally bleach griddle plate with vinegar when plate is cold.
- e. Clean with hot water, a mild detergent solution and a scrubbing brush. Dry all components thoroughly with a dry cloth.
- f. Griddle plate should be switched 'On' briefly to ensure griddle plate becomes dry. A thin smear of cooking oil should be spread over griddle plate to form a protective film.

Grilling / Toasting Area

- a. Clean grilling / toasting area with a soft cloth and a mild detergent and hot water solution.
- b. Baked on deposits or discolouration may require a good quality stainless steel cleaner or stainless steel wool. Always apply cleaner when appliance is cold and rub in direction of grain.
- c. Remove grease drawer and crumb tray, clean with a mild anti bacterial detergent and hot water solution using a soft bristled brush. Dry grease drawer and crumb tray thoroughly with a dry cloth.

Stainless Steel Surfaces

- a. Clean exterior surfaces of griddle toaster with hot water, a mild detergent solution and a soft scrubbing brush. Note that gas control knobs are a push fit onto gas control valve spindles and can be removed to clean front of control panel.
- b. Baked on deposits or discolouration may require a good quality stainless steel cleaner or stainless steel wool. Always apply cleaner when appliance is cold and rub in direction of grain.
- c. To remove any discolouration, use an approved stainless steel cleaner or stainless steel wool. Always rub in direction of the grain.
- d. Dry all components thoroughly with a dry cloth and polish with a soft dry cloth.

Periodic Maintenance

NOTE: All maintenance operations should only be carried out by a qualified service person.

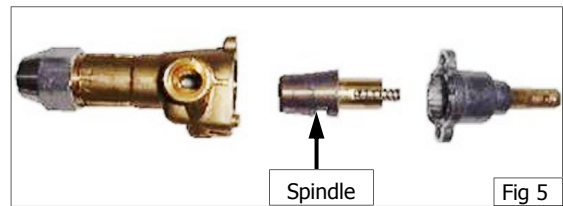
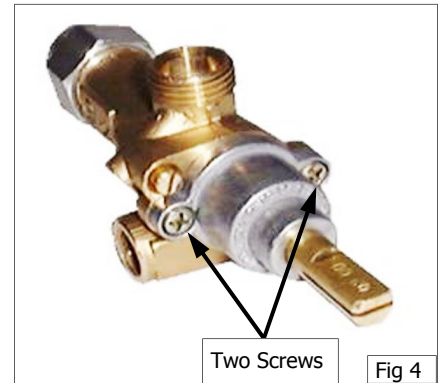
To achieve the best results cleaning must be regular and thorough and all controls and mechanical parts should be checked and adjusted periodically by a qualified service person. If any small faults occur, have them attended to promptly. Don't wait until they cause a complete breakdown. It is recommended that the appliance is serviced every 6 months.

Gas Control Valve Re-Greasing

Gas control valve should be dismantled and greased every 6 months to ensure correct operation.

To carry out this operation;-

- a. Remove gas control knobs from gas tap spindles.
- b. Remove drip tray from appliance.
- c. Remove two screws on underside of control panel, securing control panel to hob and remove control panel.
- d. Remove the 2 screws holding shaft plate to gas control body and remove control shaft and plate. Note orientation of shaft for correct re-assembly.
- e. Using needle nose pliers or similar, pull out gas control spindle, again noting its orientation.
- f. Apply a suitable high temperature gas cock grease or lubricant such as ROCOL - A.S.P (Anti scuffing paste) / Dry Moly Paste to outside of spindle.
- g. Replace spindle and re-assemble gas control in reverse order.
- h. Refit control panel to appliance.
- i. Refit knobs to gas control valve spindles.



Fault Finding

This section provides an easy reference guide to the more common problems that may occur during operation of your equipment. The fault finding guide in this section is intended to help you correct, or at least accurately diagnose problems with your equipment.

Although this section covers the most common problems reported, you may encounter a problem not covered in this section. In such instances, please contact your local authorised service agent who will make every effort to help you identify and resolve the problem. Please note that the service agent will require the following information:-

- **Model code and Serial Number of the appliance. (both can be found on Rating Plate located on appliance.**

Fault	Possible Cause	Remedy
Pilot won't light.	No gas supply.	Ensure gas isolation valve is turned on, and that bottles are not empty.
	Blocked pilot injector.	Call service provider.
Pilot goes out when gas control knob released.	Releasing knob before thermocouple has heated.	Hold knob in for at least 20 seconds following ignition of pilot.
	Pilot flame too small.	Call service provider.
	Gas pressure too low.	Call service provider.
	Pilot adjustment screw out of adjustment.	Call service provider.
	Partially blocked pilot injector. Thermocouple faulty.	Call service provider.
Main burners will not light.	Incorrect supply pressure.	Call service provider.
	Faulty gas control valve.	Call service provider.

NOTE: Components having adjustments protected (e.g. paint sealed) by manufacturer should only be adjusted by an authorised service agent. They are not to be adjusted by an unauthorised service person.

Conversion Procedure



Caution

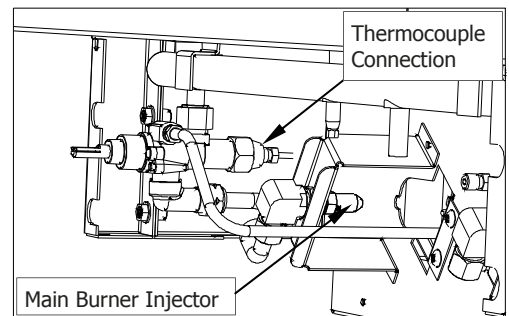
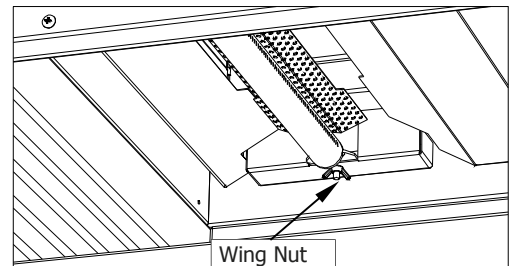
Ensure Appliance is isolated from gas supply before commencing servicing.

NOTE:

- These conversions should only be carried out by qualified persons. All connections must be checked for leaks before re-commissioning the appliance.
- Adjustment of components that have adjustments / settings sealed (e.g. paint sealed) can only be adjusted in accordance with the following instructions and shall be re-sealed before re-commissioning this appliance.
- For relevant gas specifications refer to 'Gas Specifications Tables' at rear of this section.

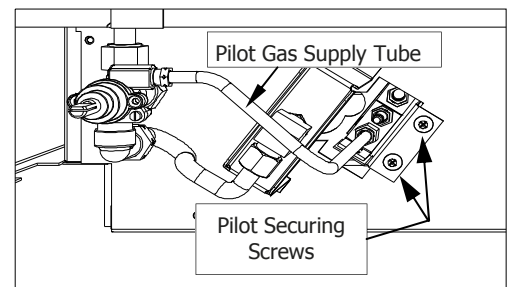
Main Burners

1. Remove the following:-
 - Control Panel.
 - Toasting Rack.
 - Main Burner.
2. Remove injectors and replace with correct size injectors as shown in 'Gas Specifications Tables' at rear of this section.
3. Refit the following:-
 - Main Burner.
 - Toasting Rack.



Pilot Burners

1. Disconnect the following:-
 - Pilot Supply and Thermocouple Tubes from Gas Control Valve.
 - Pilot Assembly from Griddle Toaster.
2. Remove pilot injectors and replace with correct size pilot injectors as shown in 'Gas Specifications Tables' at rear of this section.
3. Re-connect the following:-
 - Pilot Supply and Thermocouple Tubes to Gas Control Valve.
 - Pilot Assembly to Griddle Toaster.

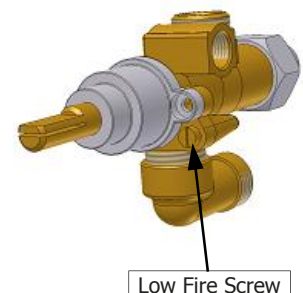


Low Fire Adjustment

1. Light main burners and check flame size on 'Low' position.
 - Adjust low fire adjustment screw on burner gas control valves to obtain desired flame size.

NOTE: 'Low Fire Adjustment Screw' should be sealed with coloured paint on completion of low fire adjustment.

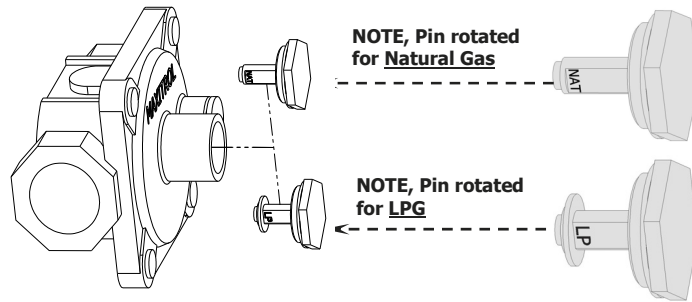
2. Refit control panel.
3. Refit gas control knobs to gas control valves.



Gas Conversion and Specifications

Gas Regulator

NAT Gas / LPG / Butane Only.

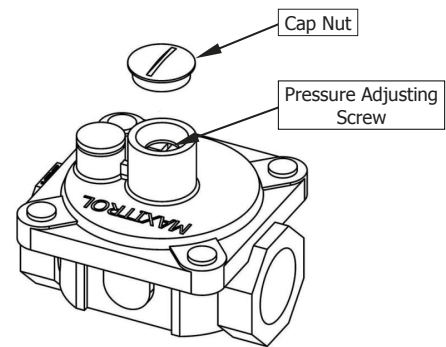


NOTE: The gas regulator supplied is convertible between Natural Gas and LP Gas, but its outlet pressure is fixed ex-factory and is NOT to be adjusted.

- Town Gas Only.

1. Remove slotted cap from regulator.
2. Turn 'On' gas supply and appliance.
3. Adjust pressure adjusting screw to achieve correct burner operating pressure.

NOTE: Operating pressure to be measured at manifold test point with both burners operating at 'High Flame' setting.



4. Turn 'Off' mains gas supply and bleed gas out of appliance gas lines.
5. Turn 'On' gas supply and appliance.
6. Verify operating pressure remains correct (Re-adjust regulator if required).
7. Screw cap nut back onto regulator.

Gas Type Identification Label

On completion of gas conversion, replace gas type identification label located at:-

- Rear of appliance, above gas connection.
- Beside the rating plate.

Commissioning

Before leaving the installation;

1. Check all gas connections for leakage using soapy water or other gas detecting equipment.





Warning

DO NOT USE A NAKED FLAME TO CHECK FOR GAS LEAKAGES.



2. Carry out a 'Commissioning' check of appliance as shown in Installation Section of this manual.
3. Ensure any adjustments done to components that have adjustments / settings paint sealed are to be re-sealed.

Gas Specifications

- Australia:



	Natural Gas	LP Gas (Propane)
Main Burner Injector	2.10mm	1.30mm
Pilot Burner Injector	0.35mm	0.23mm
Low Fire Adjustment	1 turn out (c.c.w.)	½ turn out (c.c.w.)
Operating Pressure	1.0 kPa (*)	2.5 kPa (*)
Supply Pressure	1.13 - 3.40 kPa	2.75 - 4.50 kPa
Burner Aeration Gap	15mm (Open)	15mm (Open)
Gas Regulator Cap Screw		

- New Zealand:

	Natural Gas	LP Gas
Main Burner Injector	2.10mm	1.30mm
Pilot Burner Injector	0.35mm	0.23mm
Low Fire Adjustment	1 turn out (c.c.w.)	½ turn out (c.c.w.)
Operating Pressure	1.0 kPa (*)	2.5 kPa (*)
Supply Pressure	1.13 - 3.40 kPa	2.75 - 4.50 kPa
Burner Aeration Gap	15mm (Open)	15mm (Open)
Gas Regulator Cap Screw		

- UK Only

Category: **II_{2H3P} (20, 30 / 37).**
 Flue Type: **A₁.**


	Natural Gas (G20)	Propane (G31)
Main Burner Injectors	2.10mm	1.30mm
Pilot Burner Injectors	0.35mm	0.23mm
Low Fire Adjustment	1½ turn out (c.c.w.)	½ turn out (c.c.w.)
Operating Pressure	10 mbar (*)	26 mbar (*)
Supply Pressure	20 mbar	37 mbar
Burner Aeration Gap	15mm (Open)	15mm (Open)
Gas Regulator Cap Screw		


NOTE:

- * - Measure burner operating pressure at manifold test point with both burners operating at full setting. Operating pressure is ex-factory set, through the appliance regulator and is not to be adjusted, apart from when carrying out Gas Conversion, if required. (Refer to 'Gas Conversion' section for details).

Gas Conversion and Specifications

- All Other Markets:

	Natural Gas	Town Gas
Main Burner Injectors	Ø 2.10mm	Ø 3.80mm
Pilot Burner Injectors	0.35	0.60
Low Fire Adjustment	1 turn out (ccw)	2 turns out (ccw)
Burner Operating Pressure (*)	1.0kPa (*)	0.63kPa (*)
Main Burner Aeration Shutter	Fully Open	Fully Open
Gas Regulator Cap Screw		Adjustable Regulator (Adjust to Burner Operating Pressure)

	LP Gas (Propane)	Butane
Main Burner Injectors	Ø 1.30mm	Ø 1.20mm
Pilot Burner Injectors	0.23	0.23
Low Fire Adjustment	½ turn out (ccw)	½ turn out (ccw)
Burner Operating Pressure (*)	2.5kPa (*)	2.5kPa (*)
Main Burner Aeration Shutter	Fully Open	Fully Open
Gas Regulator Cap Screw		

(*) NOTE:

- Measure Burner operating pressure at manifold test point with both burners operating at 'High Flame' setting.
- NAT, LPG & Butane Only - Operating pressure is ex-factory set and is not to be adjusted, unless when converting between gasses, if required.
- TOWN GAS Only -Adjust burner operating pressure using adjustable gas regulator supplied.
- Refer to the details in this section for further details.

Replacement Part List

IMPORTANT

Only genuine authorized replacement parts should be used for servicing and repair of this appliance. The instructions supplied with parts should be followed when replacing components. For further information and servicing instructions, contact your nearest authorized service branch (contact details are as shown on reverse of front cover of this manual).

When ordering replacement parts, please quote part number and description as listed below. If part required is not listed below, request part by description and quote model and serial number which is on rating plate.

Controls

231558	Burner Complete with Fret.		
034210	Burner Injector	(Natural Gas)	Ø 2.10mm.
034130	Burner Injector	(LPG)	Ø 1.30mm.
037120	Burner Injector	(Butane)	Ø 1.20mm.
037380	Burner Injector	(Town Gas)	Ø 3.80mm.
227403	Gas Control Valve	(c.w. Elbow).	
019215K	Pilot Burner.		
026488	Pilot Injector	(Natural Gas)	- 0.35mm.
019217	Pilot Injector	(LPG)	- 0.23mm.
018067	Pilot Injector	(Town Gas)	- 0.60mm.
019428	Thermocouple.		
227378	Gas Control Knob.		
227508	Piezo Igniter.		
228047	HT Lead 250mm.		
018744	Electrode.		

General

227007	Toasting Rack.
227006	Side Racks.
227086	Toasting Rack Tray (Stainless Steel).
227083	Crumb Tray (Enamelled).
227070	Grease Drawer.
227850	Adjustable Legs 150mm.
229674	Rear Roller Assy.

Gas Regulators

Gas Type	Gas Regulators	
	Part No.	Description
Nat. Gas LPG (Propane) Butane	228533	½" BSP F/F Convertible.
Town Gas	230185	¾" BSP F/F Adjustable.

Replacement Parts List

Accessories

228795	Plinth Kit - 600mm.
228566	Griddle Scraper Tool.
228567	Smooth Plate Scraper Blades (Pack of 5 blades).

Gas Conversion Kits

Model	Gas Type to Convert to			
	Nat. Gas	LPG (Propane)	Butane	Town Gas
G55T	231980	231979	231981	232013

