



HOSHIZAKI EUROPE B.V.

## HOSHIZAKI SERVICE MANUAL

**ADVANCE K70 / K140 / F70 / F140**



**As the user, please use the operating instructions.  
This service manual does not include operating instructions.  
It is only intended for the service technician.  
The user requires important safety information not included  
here.**



## Content

Safety information.....	3
Intended use.....	3
Suitable installation site .....	3
Distance from walls and ceiling .....	4
Setting up several devices side by side.....	5
Unpacking and installing the device .....	6-7
Devices on feet.....	8
Devices on castors .....	8
Condensation water re-evaporation .....	8
Electrical connection.....	9
Instructions for daily use .....	9
Cleaning and maintenance .....	10-11
Control elements .....	12
Touch keys .....	12
Display symbols.....	13
Device settings .....	14
Commissioning.....	14
Switching on (from standby state) .....	14
Start defrost.....	14
Key lock, sleep mode.....	14
Display of set temperature (set point).....	15
Temperature setting (changing the set point) .....	15
Switching off the device in standby mode.....	15
Alarm and fault messages, display of the defrosting process .....	15
Evaporator sensor temperature display.....	16
Room sensor temperature display .....	16
Compressor run time display (operating time counter).....	16
Deleting the compressor run time (operating time counter) .....	16
Setting the alarm limits.....	16
Resetting to factory settings (as-delivered state of the controller) .....	17
Reading and changing the service parameters .....	17
Parameters List .....	18-19
Switching the door hinge side.....	20-21-22
Removing and installing evaporator cover.....	23
Measures for taking the device out of operation for long periods.....	24
Disposal.....	24
Technical support .....	25
Ordering spare parts.....	25
Technical data .....	26
Dimensions.....	27-28
Wiring diagram .....	29-30
Mounting and connecting the controller.....	31
Cooling system.....	31
EU Declaration of Conformity K70 / K140 / F70 / F140.....	32
UKCA Declaration of Conformity K70 / K140 / F70 / F140 .....	33



## Safety information



This service manual does not include comprehensive operating instructions for the user; it is only a further supplement to the operating instructions.

It is intended for a trained service technician. As a result, many important safety instructions for the user are missing with regard to the scope and readability. In case of doubt, please observe the information in the operating instructions for transport, installation, operation and electrical safety and never pass on this service manual in place of the operating instructions.

## Intended use

This device is intended for the storage of packaged foods at a constant temperature. This device must not be used to cool down or freeze foods.

Area of application:

Climate category	Ambient temperature and air humidity
5	+40°C with %40 RH

## Suitable installation site

The device must be installed in a dry, well ventilated room away from direct sunlight at a sufficient distance from radiators and other sources of heat. Please always take into account the waste heat of all devices installed in one room. The ambient temperature must lie between a minimum of +16°C and a maximum of +40°C. A gap of at least 0.5 metres must be kept between the top edge of the machine compartment and the ceiling. The air exchange in this area must not be obstructed from the front or the side by screens etc. hanging from the ceiling.

For electrical safety reasons, the device must not be operated outside. The refrigeration technology of the device does not function outside or in unheated rooms (particularly in colder seasons) and can be damaged by low temperatures.



**Distance from walls and ceiling:**



A gap of at least 50 cm must be kept between the top edge of the machine compartment and the ceiling, and of at least 50 mm from walls, furniture and other devices.

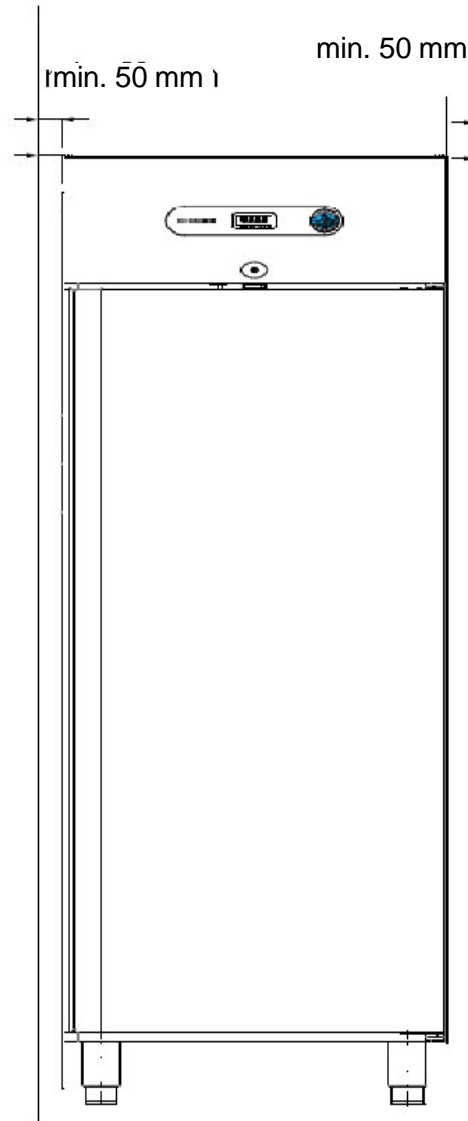
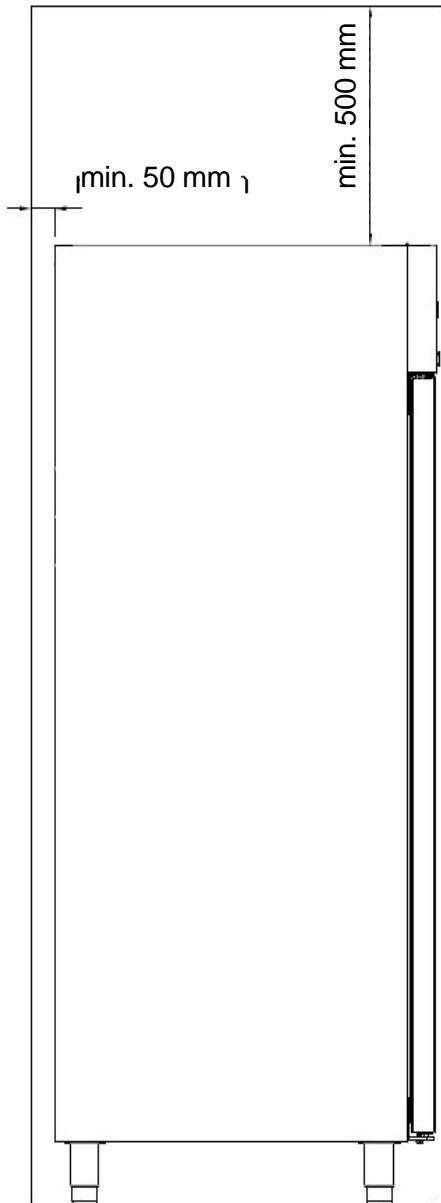



## Setting up several devices side by side

Depending on the temperature and air humidity at the installation site as well as the selected set point setting, the water in the ambient air can condense on the surface of a refrigerating unit due to its design.

If several cooling or refrigeration units are set up side by side, this condensation effect becomes stronger, and a lower air quantity can circulate between the devices. As a result, a minimum distance of **30 to 50 mm** must be kept between the devices depending on the temperature and air humidity.

These gaps must not be sealed either at the top or bottom, but can be covered by a stainless-steel panel from the front for aesthetic purposes. The panel must be removable for cleaning within the gaps.

If it is not possible for air to circulate freely at the bottom, e.g. due to a base installation, then the gaps cannot be sealed at the front.

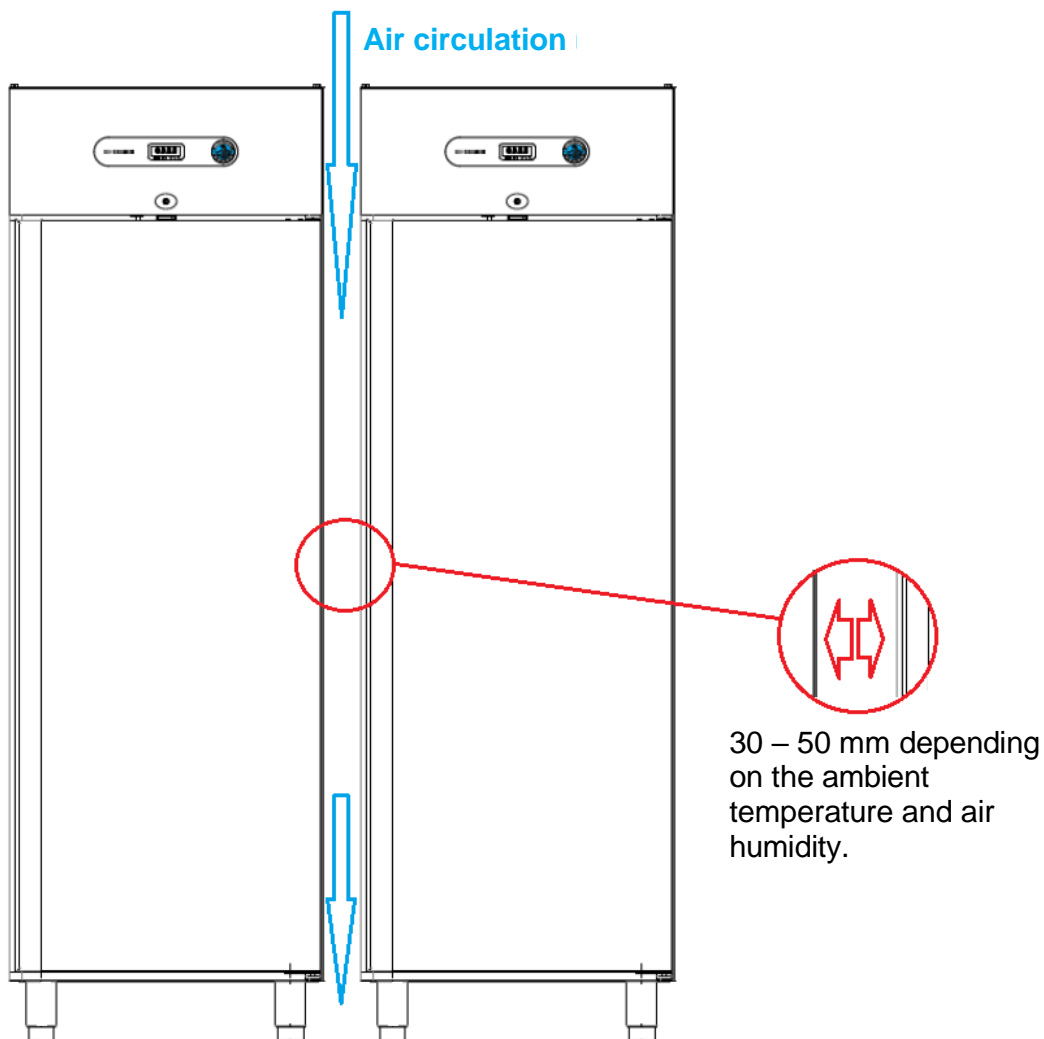



## Unpacking and installing the device

The device must be placed on its back in order to remove the pallet beneath it.



**Warning** The device's centre of gravity is located at the top by the machine box (top heavy). At least two people are required to lay down the device and set it upright again. Safety shoes and safety gloves must be worn.



**Important** If the device has laid on its back or was transported horizontally, then it must stand upright for at least two hours before switching it on to allow the oil to collect in the compressor.

Once the device is on its back, the transport pallet must be removed by the following sequence;

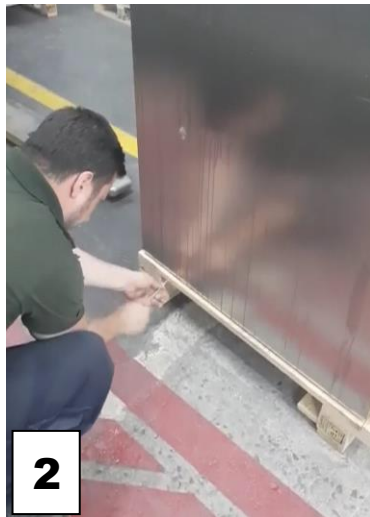
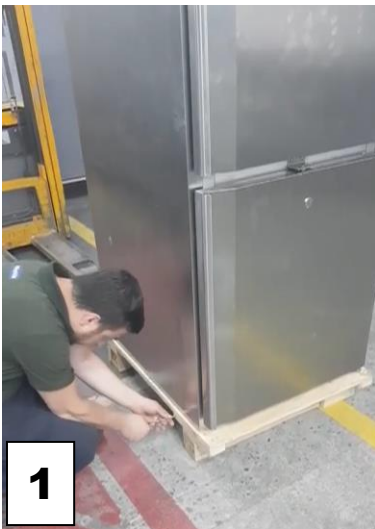

1-2-3) 2 pieces of long wooden pieces at the bottom of the pallet are detached from the lower part of the pallet with the help of a screwdriver from the left side of the refrigerator.

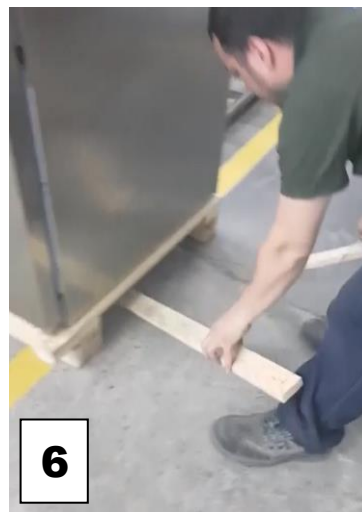

4-5-6) The other side of the long wooden pieces is moved to the right side of the refrigerator and detached from the bottom of the pallet with the help of a screwdriver.

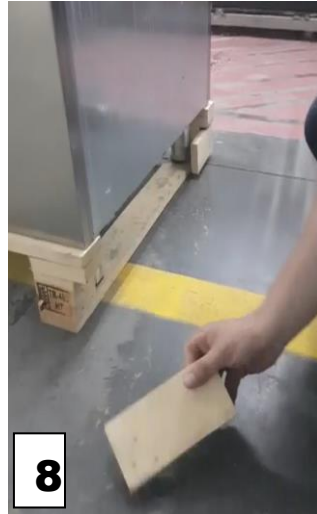

7-8-9) Then, 2 pieces of short wooden pieces at the back of the pallet are removed by hand. Once the pieces of wood that hold the cabinet to the pallet are removed, it means the cabinet is no longer connected to the pallet.



10-11-12) With the help of a pallet truck or by means of 2 people, the cabinet is first tilted to one side from the pallet and then the pallet is removed from the bottom.



13-14) After the pallet leaves the refrigerator, the refrigerator is left slowly and with its feet evenly on the floor.



## Devices on feet

Cabinets on feet require an even, durable floor. Cabinets on feet are levelled by turning the internal part of the feet (see figure):

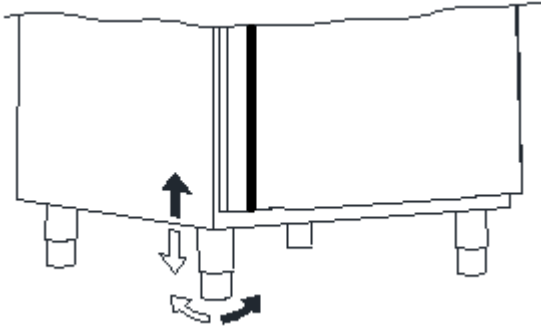

## Devices on castors

Cabinets on castors require a level, even and durable floor to provide a stable foundation. After correctly positioning the device, the two brakes on the front castors must be applied (see figure)

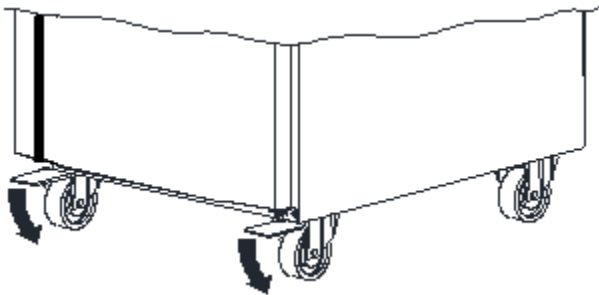

**Devices on castors must not be placed on a platform.**

## Condensation water re-evaporation

The cabinets are equipped with a chamber for re-evaporation of the condensation water on top of the cabinets. This equipment is intended for the amount of condensation water that accumulates on average with a maximum of 72 door openings per day according to EN16825.

The actual amount of condensation water may vary depending on usage and ambient conditions. If the number of door openings per day exceeds 72, or the condensation water pan overflows due to other usage factors, the user must use the product strictly under the specified conditions to prevent overflow.

If the amount of condensation increases despite not changing the usage or the ambient conditions, the device may have a defective door seal or a door that does not close properly.





## Electrical connection

The 220-230 V/50 Hz mains connection is established by plugging the provided cable with appliance connector into a socket with earthed protective contact.

30 mA residual current circuit breaker is required.

There may be special regulations from your local energy supply company regarding earthing measures that must be observed.



**When working with the electrical equipment, the device must always be disconnected from the mains by pulling out the power plug. It is NOT sufficient to switch off the device with the ON/OFF button as parts of the device are still live**

## Instructions for daily use

In order to achieve the necessary air circulation in the interior, only store goods within the corresponding markings (loading marks) and on the grates (never on the floor or in front of the air outlets).

Do not store goods above the top loading mark.

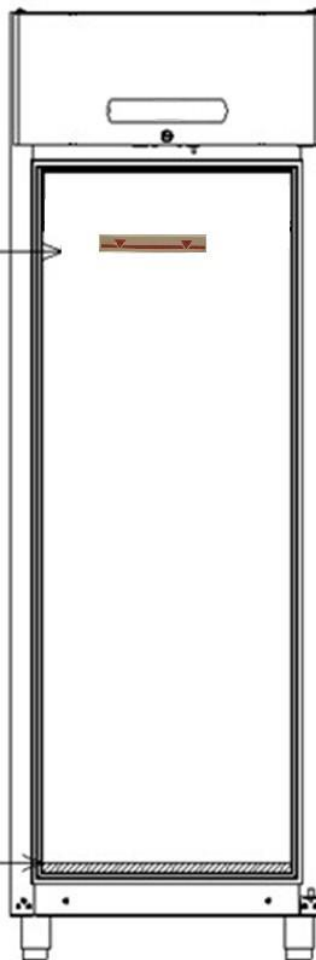

Do not store goods below the bottom grate.

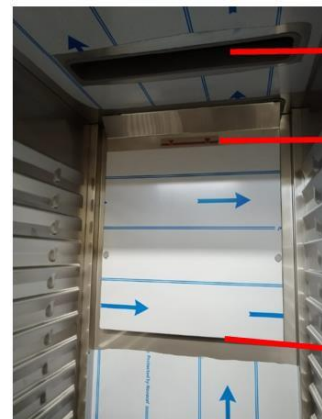
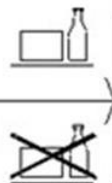

Air Inlet

Top Loading Mark

Air Outlet

No electrical devices may be operated inside the device.



## Cleaning and maintenance

The device must be cleaned regularly. The intervals depend on the usage and level of soiling (at least annually).



Before carrying out any cleaning or maintenance operations, unplug the unit



Don't touch or wet the machine compartment parts. This could result in failure or breakdown.



To prevent possible damage, don't clean the plastic parts with water above 40° C or in a dishwasher.

### Interior & Exterior of Cabinet and Shelves



Clean the interior and exterior at least once a week for sanitary use.



Clean off the interior and exterior of cabinet with a soft cloth soaked in cold or warm water containing the proper amount of neutral cleaner and wrung dry. Don't use a water jet to clean the machine compartment.



Chemical agents other than neutral cleaner might cause damage to the interior and exterior surfaces.



Any remaining detergent will damage metal or plastic surfaces. Use a soft cloth dampened with warm water to wipe it off.



Don't use the following items, they could damage painted or plastic surfaces:

- Polishing powder, alcohol, thinner, benzene, acidic or alkaline detergent, hot water, petroleum, soap powder, metal scourer or brush, etc. Especially detergent to clean grease on ventilator or microwave

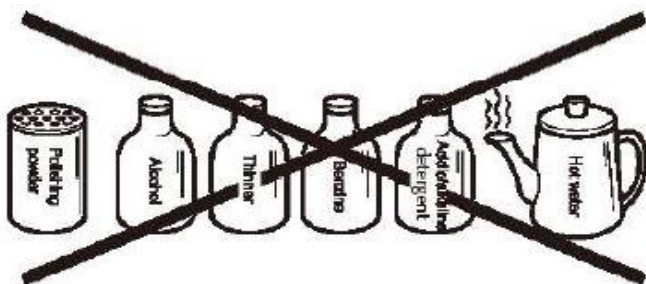

**Note:** Some solutions other than the above may also damage painted or plastic surfaces. Immediately stop using such solutions if they cause any problems!



The door gasket and its contact surface get soiled easily. Clean every surface of these parts thoroughly. Remnants of food will accelerate aging.



Use a cloth to wipe off any water staying inside the cabinet.



## Cleaning and maintenance

### Condenser



Use vacuum cleaner or a soft brush to remove dust and stains from the condenser.



**Warning:** If users clean the condenser with hard brush, such as dishwasher brush, the coating of condenser may peel off.

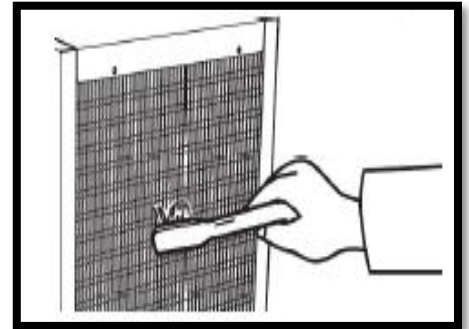

### Air Filter



To prevent deformation do not wash the air filter hot water above 40°



Plastic mesh air filters remove dirt or dust from the air and keep the condenser from getting clogged. If the filters get clogged, the refrigerator/freezer's performance will be reduced.



Check the filters at least twice a month. When clogged or when the temperature controller shows error, use warm water and a neutral cleaner to wash the filters. Don't operate the unit with the air filters removed, or the condenser will get clogged, resulting in failure.

- 1) Open the front panel and remove the air filter. To prevent injury, don't touch the condenser fins directly.
- 2) Wash the air filter carefully with cold or warm water containing the proper amount of neutral cleaner. Rinse and dry the air filter thoroughly.
- 3) To refit the air filter, put the two tabs into the heat exchanger or fins in condenser and tightly attach the air filter over the condenser.

**Control elements**

**Indicators**

**Indicators:**

- Compressor operating display
- Energy saving / sleep mode s
- Temperature unit
  - Degrees Celsius
  - Degrees Fahrenheit
- Standby: Device switched off but connected to the mains supply
- Evaporator fan operating display
- Display of ongoing defrosting



**Touch keys (capacitive):**

- SET (lock icon):**
  - Brief-press once:
    - Adjust set point
    - Select and save parameter settings
  - Long-press and hold:
    - Call up configuration parameters
    - Load factory settings
- Power (power icon):**
  - Brief-press once:
    - Leave parameter settings
  - Long-press and hold:
    - Switch on/off
- Down arrow (down arrow icon):**
  - Brief-press once:
    - Reduce values
    - Navigate down in the menu
  - Long-press and hold:
    - Sensor display
    - Compressor operating time counter
- Up arrow (up arrow icon):**
  - Brief-press once:
    - Increase values
    - Navigate up in the menu
  - Long-press and hold:
    - Start manual defrosting







**Touch keys**

Key	Function description
	By briefly pressing the key, you can adjust the set point or open a parameter within the parameter settings, save any value changes and leave the settings. By pressing the key for a longer time, you can call up the configuration parameters or the reset to factory settings. The longer key press will also remove the automatic key lock.
	By briefly pressing the key, you can discard a change in the parameter settings and exit the setting. By pressing the key for a longer time, you can switch the device on and off, provided the switch-off is not prevented by the parameter "POV"=0. The longer key press will also remove the automatic key lock.



Key	Function description
	By briefly pressing the key, you can increase the displayed value (set point, parameter or password input). Pressing the key for a longer time starts the manual defrosting. The longer key press will also remove the automatic key lock.
	By briefly pressing the key, you can decrease the displayed value (set point, parameter or password input). By pressing the key for a longer time, the sensor temperatures “Pb1”, “Pb2” and the compressor operating time counter “Ch” are called up and deleted under “rCh”. The longer key press will also remove the automatic key lock.

## Display symbols

Symbol	Meaning
	This symbol shows that the device is connected to the mains supply but is switched off (standby mode).
	If this symbol lights up, the compressor is switched on. If this indicator flashes, either the temperature set point is being changed or the compressor is starting but is delayed by the controller safety settings (parameter “C0”, “C1”, “C2”).
	This symbol lights up constantly throughout the defrosting. If it flashes, the dripping time is running or the start of the defrosting phase has begun but is delayed by a continuous minimum compressor running time.
	If this symbol lights up, the evaporator fan is running. If it flashes, the fan is deactivated or the start is delayed due to the parameter settings.
	If this symbol as well as the temperature indicator light up, the device is operating in energy saving mode. This indicator is purely informative (the energy saving operation cannot be manually switched on or off). If only this symbol lights up, the control panel is also in sleep mode in order to save energy from the display. You can end sleep mode by pressing any key.
	Not used for this device
<b>HACCP</b>	Not used for this device
<b>AUX</b>	Not used for this device



## Device settings



All settings are configured via the capacitive touch keys of the control panel on the front of the device. There are no function elements for the menu selection, parameter settings or sensor calibration on the back of the device.

## Commissioning

The cabinet must be connected to the mains using the connection cable provided (safety plug). This is followed by testing all the display segments.

If the device was switched off before being disconnected from the mains, the device will go into standby mode after the display test. If it was switched on before being disconnected from the mains, it starts in normal operation with the most recently set temperature set point.

## Switching on (from standby state)

You switch on the cabinet by pressing the ON/OFF button  for approximately 4 seconds.  flashes while it is being switched on. No display test follows.

## Start defrost

In the default settings, the device starts without a start defrost. If the parameter “**d4**” has been changed to “1”, the start defrost begins and lasts for max. the time period “d3” or ends upon reaching the temperature “**d2**” on the evaporator sensor. The compressor starts once the time period “**C0**” has elapsed at the earliest.

## Key lock, sleep mode

The keys lock automatically if no key has been pressed for 30 seconds in order to prevent unintentional entries due to fleeting contact or while wiping the control panel. The abbreviation “Loc” is displayed in this case. “Loc” is also displayed when a key is touched while locked. The keypad can be unlocked by pressing any key for 4 seconds; “UnL” is displayed.

The display switches off during the energy saving function after the time period “**HE3**”, then only the symbol  remains lit. The display switches back on when any key is pressed.



### Display of set temperature (set point)

If required, the keypad can be unlocked by pressing any key for 4 seconds; “UnL” is displayed. Briefly press the key ; the compressor indicator flashes and the temperature set point is displayed. By briefly pressing or again, or after 15 seconds without pressing any keys, the device returns to normal operation.

### Temperature setting (changing the set point)

If required, the keypad can be unlocked by pressing any key for 4 seconds; “UnL” is displayed. Briefly press the key ; the compressor indicator flashes and the temperature set point is displayed; it can be changed via or . Press to save the value and leave the parameter. You can leave and discard the change (escape) by pressing .

### Switching off the device in standby mode:





You switch on the cabinet by pressing the ON/OFF button for approximately 4 seconds. flashes while it is being switched off. In standby mode, is constantly lit.

### Alarm and fault messages, display of the defrosting process





Indicator	Description
AL	Lower temperature alarm, parameter “A1”, delay “A7”
AH	Upper temperature alarm, parameter “A4”, delay “A7”
dEF	Device is undergoing the defrost process (if “D6”=“2”) or a reset to default factory settings
ld	Door alarm, parameter “ld”, parameter “i0”, “i1”
Pr1	Defective room sensor, emergency programme parameter “C4”, “C5”
Pr2	Defective evaporator sensor, defrosting after time period “d3”







## Evaporator sensor temperature display

Press the key  for approx. 2 seconds until “rCH” appears, then press  until “Pb2” is displayed. The evaporator temperature is displayed after pressing the key . The display disappears after briefly pressing  or , or automatically after 60 seconds without touching any keys.







## Room sensor temperature display

Press the key  for approx. 2 seconds until “rCH” appears, then press  until “Pb1” is displayed. The room temperature is displayed after pressing the key . The display disappears after briefly pressing  or , or automatically after 60 seconds without touching any keys.

## Compressor run time display (operating time counter)

Press the key  for approx. 2 seconds until “rCH” appears, then press  until “CH” is displayed. The counter reading is displayed after pressing the key . The display disappears after briefly pressing  or , or automatically after 60 seconds without touching any keys.

## Deleting the compressor run time (operating time counter)

Press the key  for approx. 2 seconds until “rCH” appears. If required, press  until “rCH” is displayed. Briefly press the key ; “0” is displayed. Within 15 seconds, press the key  or  to input the password “149” for resetting the counter and briefly press . The indicator “-” flashes on the display for 4 seconds. The counter has been reset.

## Setting the alarm limits







The controller does not manage separate user parameters except for the temperature set point “SP”. The alarm settings are configured in the configuration parameters; see below.









## Resetting to factory settings (as-delivered state of the controller)



This loads the default values (factory settings) set by the controller supplier. Please note that these do not necessarily match the as-delivered state of the cooling or refrigeration device; individual parameters may need to be adjusted.







Press and hold the key  SET for approximately 4 seconds, and "PA" will appear on the display. Briefly press the key  SET; "0" is displayed. Within 15 seconds, press the key  or  to input the password "149" for resetting the factory settings and briefly press  SET. "dEF" will be displayed. Briefly press the key  SET; "0" is displayed.

Within 15 seconds, use the key  or  to set this value to "4" and briefly press  SET again. The indicator "- -" flashes on the display for 4 seconds. The process must then be completed by restarting the device by disconnecting it from the mains. After the restart, the device will be in normal operation mode.

## Reading and changing the service parameters

No other procedure can be running. Press and hold the key  SET for 4 seconds. "PA" is indicated on the display. Briefly press the key  SET; "0" is displayed.

Within 15 seconds, use the key  or  to input the password (default value "-19") and briefly press  SET. The first parameter "SP" (set point) is displayed.

Use the keys  and  to switch between the parameters and  SET to open a parameter. The set value appears, and it can be changed using  and . Press  SET to save the value and leave the parameter. You can leave and discard the change (escape) by pressing . You then leave the settings menu and return to the normal temperature display.

You can also leave the configuration parameter (while saving the changes) by pressing  SET for 4 seconds, or it happens automatically after 60 seconds if no further keys are pressed.

\*The password can be changed via the "PAS" parameter.



**PARAMETER LIST**

		<b>K70</b>	<b>K140</b>	<b>F70</b>	<b>F140</b>
<b>P. CODE</b>	<b>DESCRIPTION</b>	<b>VALUE</b>	<b>VALUE</b>	<b>VALUE</b>	<b>VALUE</b>
<b>SP</b>	Set point	3	3	-20	-20
<b>CA1</b>	Room sensor offset	0	0	0	0
<b>CA2</b>	Evap sensor offset	0	0	0	0
<b>P0</b>	Sensor type	1	1	1	1
<b>P1</b>	Decimal point	1	1	1	1
<b>P2</b>	Unit of measurement	0	0	0	0
<b>P4</b>	Second analog input	1	1	1	1
<b>P5</b>	Magnitude displayed	0	0	0	0
<b>P8</b>	Delay display of temp.	0	0	0	0
<b>r0</b>	differential	3.0	3.0	3.0	3.0
<b>r1</b>	Min working set point	0	0	-22	-22
<b>r2</b>	Max working set point	10	10	-10	-10
<b>r4</b>	Working set point increase	2.0	2.0	2.0	2.0
<b>r5</b>	Operation type	0	0	0	0
<b>r12</b>	Differantial type	1	1	1	1
<b>C0</b>	Delay switching on comp.	0	0	0	0
<b>C2</b>	Min comp switch off dur.	2	2	2	2
<b>C3</b>	Min comp swtich on time	0	0	0	0
<b>C4</b>	Dur. comp. Sw. Off Pr1 err	5	5	5	5
<b>C5</b>	Dur. comp. Sw. On Pr1 err	5	5	5	5
<b>C6</b>	Cond. Over heat alarm	60	60	60	60
<b>C7</b>	Cond. Comp shut down alarm	65	65	65	65
<b>C8</b>	Comp. Shut down alarm delay	1	1	1	1
<b>d0</b>	defrost interval	12	6	6	4
<b>d1</b>	Type of defrost	2	2	0	0
<b>d2</b>	Temperature at end of defrost	8	8	8	8
<b>d3</b>	Max defrost duration	60	60	60	60
<b>d4</b>	Defrost when device switched on	0	0	0	0
<b>d5</b>	Time defrost activ. - switch on	0	0	0	0
<b>d6</b>	Display temp during defrost	2	2	2	2
<b>d7</b>	Dripping duration	2	2	3	3
<b>d8</b>	Defrost activation type	0	0	0	0
<b>d9</b>	Evap temp. For suspend defr. interval	0	0	0	0
<b>d11</b>	Defrost max time reached err.	0	0	0	0
<b>d15</b>	Min comp sw. on time before defrost	0	0	0	0
<b>d18</b>	Defr. interval evap temp below d22	100	100	100	100
<b>d19</b>	Defrost activ. Evap temp. Below	3	3	3	3
<b>d20</b>	Comp. Swit. On consicu. Time for defr.	240	240	240	240



<b>d22</b>	Evap temperature for d18	2	2	2	2
<b>A1</b>	Min. room temperature alarm	10	10	10	10
<b>A4</b>	Max. room temperature alarm	10	10	10	10
<b>A6</b>	Dly max room temp. Alrm aft swit. on	99	99	99	99
<b>A7</b>	Delay min max temp	120	120	120	120
<b>A8</b>	Dly max temp alm aftr evap fan stnstll	120	120	120	120
<b>A9</b>	Dly max temp alm aftr door swt input	30	30	30	30
<b>A11</b>	Differential of A1 and A4	1	1	1	1
<b>F0</b>	Evap fan activity	3	3	3	3
<b>F1</b>	Evap fan switch off above temp	8	8	8	8
<b>F2</b>	Evap fan activity during defr. and drip	1	1	0	0
<b>F3</b>	Evap fan deactvion after comp swt on	2	2	2	2
<b>F4</b>	Evap fan swt off during enrgy save fnc	30	30	30	30
<b>F5</b>	Evap fan swt on during enrgy save fnc	30	30	30	30
<b>i0</b>	Evap fan or comp activton by door swt	2	2	2	2
<b>i1</b>	Door switch activity type	1	1	1	1
<b>i2</b>	Door switch alarm activity and delay	2	2	2	2
<b>i3</b>	Door switch activity time	10	10	10	10
<b>i10</b>	Door swit activity and abot enrgy sving	0	0	0	0
<b>i13</b>	Numbr of door swt act for defrost	0	0	0	0
<b>i14</b>	Min duration of door swt for defrost	0	0	0	0
<b>u0</b>	2nd relay management	1	1	1	1
<b>u2</b>	aux input manuel activated	1	1	1	1
<b>u4</b>	door resistances start time	1	1	1	1
<b>HE2</b>	Max duration for energy saving	0	0	0	0
<b>HE3</b>	Energy saving func activation	0	0	0	0
<b>POF</b>	Key activation	1	1	1	1
<b>PAS</b>	Access to password	-19	-19	-19	-19



### Switching the door hinge side:

The door hinge side can be changed without additional parts. The hinge brackets are asymmetrical, so you must take special care to not get them mixed up – if in doubt, label them before making the modification.



Since physical strength is required to change the door hinges on two opposite ends of the door, the door hinge change should be carried out by two suitably qualified persons for safety reasons. Otherwise, there is a risk of injury and damage to the device.

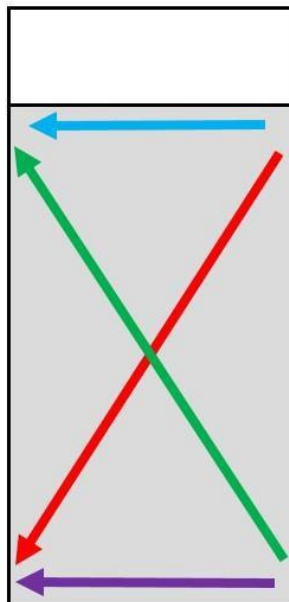

Change from DIN right to DIN left links

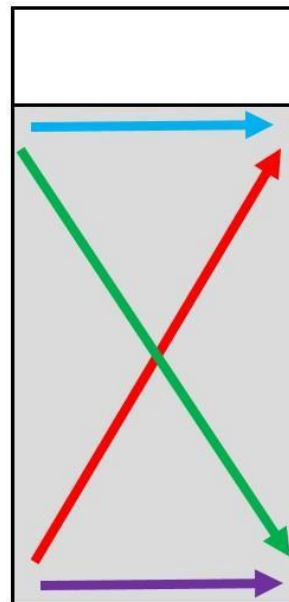

Change from DIN left to DIN right rights



#### Change from DIN right to DIN left:

The door is turned by 180°, then the hinge brackets are moved diagonally, rotated by 180°. The doorcloser is moved from the bottom right to the bottom left; the square with M8 internal thread is moved from the top right to the top left.

#### Change from DIN left to DIN right:

The door is turned by 180°, then the hinge brackets are moved diagonally, rotated by 180°. The doorcloser is moved from the bottom left to the bottom right; the square with M8 internal thread is moved from the top left to the top right.



The following description applies to the modification from DIN right to DIN left. In the opposite situation, the corresponding procedure is reversed.

		
<p>1. Remove the fastening screw in the middle at the bottom edge of the machine box panel.</p>	<p>2. Fold the machine box panel upwards and secure it against folding back down using adhesive tape or similar.</p> <p> <b>Risk of injury!</b></p>	<p>3. Open the door at an angle of around 120°.</p>
		
<p>4. Remove the screw from the door closer square at the bottom right hinge. (wrench size 8 mm).</p>	<p>5. Remove the fastening screw (wrench size 13 mm) on the top right hinge.</p>	<p>6. Pull out the door under the top hinge bracket and lift it out of the lower hinge bracket.</p>



<p>7. Remove the door closer without turning the door closer square.</p>	<p>8. Move the hinges from the bottom right to the top left, and from the top right to the bottom left; PH2 screwdriver. 9. Remove the blind plugs for this.</p>	
<p>10. Move the lock fitting from the former top edge to the intended top edge of the door.</p>	<p>11. Place the door closer at the bottom left at an opening angle of 180°, and put the bottom left corner of the door over the door closer with the recess provided.</p>	<p>12. Push the top left door corner over the hinge bracket there and screw in the M8 screw.</p>
<p>13. Screw in the fastening screws of the door closer at the bottom left.</p>	<p>14. Break out the left recess at the bottom of the machine box flap.</p>	<p>15. Close and screw on the machine box panel.</p>



## Removing and installing the evaporator cover

It is very important that the evaporator box is tightly closed and that no air enters from the edges. For this, copper pipes and cables at the entrance of evap will be wrapped with insulation tape and insulation will be made by placing only paste on the bottom part. Likewise, putty will be placed in the water drain and insulation will be made. After closing the box; It will be checked that there is no air gap between the box and the body. The cover can be removed and reattached according to the following procedure.

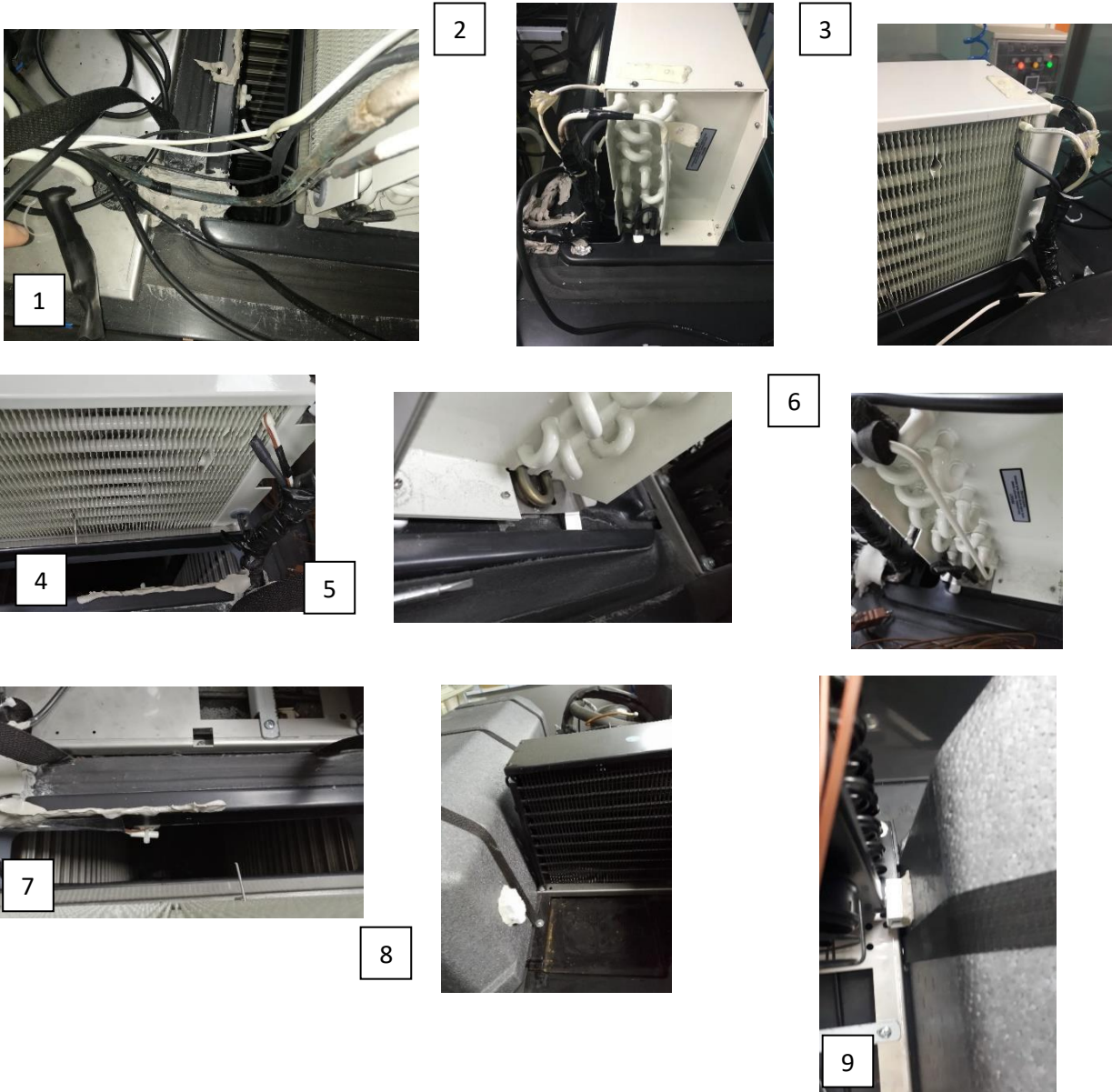

When a component changes in case of any malfunction in the cooling system, it is very important to change your dryer,





## Measures for taking the device out of operation for long periods

- Disconnect the power plug from the socket or switch off the circuit fuse.
- Remove all foods from the cabinet.
- Clean the cabinet (see cleaning section).
- Do not fully close the door; this will prevent unpleasant odours



**Warning** Please note that as soon as you disconnect the device from the mains, condensation water may drip from the cabinet onto the floor. This could damage the floor and make it slippery.

## Disposal

Electrical and electronic equipment (EEE) contains materials, components and substances that could pose a threat to humans and the environment if proper disposal (WEEE) is not observed.

Products labelled with a crossed-out bin symbol belong to this group of electrical and electronic components. The crossed-out bin symbol indicates that this type of waste must not be disposed of with regular household waste, but must instead be collected and sorted separately.

If the device requires disposal, this must be carried out in a proper and environmentally friendly manner. The applicable laws and directives related to disposal must be observed.

Please ask your specialist dealer or your local authority about proper disposal.

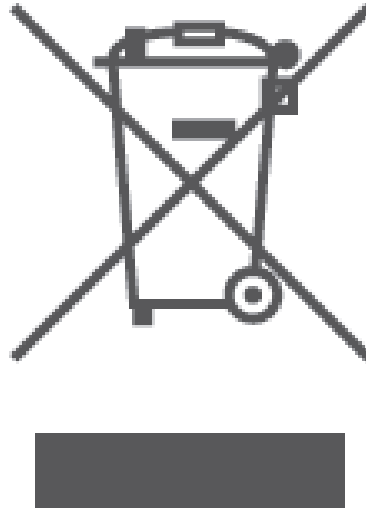





## Technical support

Technical support for **resellers and service partners**:

Hoshizaki Europe B.V. German branch, Hasede site  
Kampstr. 16  
31180 Giesen  
Germany

E-mail: **stoerung-kuehlschrank@hoshizaki.de**  
Telephone +49 5121 69737 – **46 / -48**  
Fax: +49 5121 69737 - **19**

in case of emergencies (only for working service technicians):  
Telephone +49 5121 69737 - **99** (Johannes Ullmann)

In the event of faults, please first check if the device is connected to the mains, then check the fault indicator on the display and consult the service manual.

## Ordering spare parts:

Spare parts can only be ordered **from commercial resellers** (refrigeration specialist companies, dealers, purchasing cooperatives, e.g. BÄKO) and **in writing (e-mail, fax, conventional mail)**.

E-mail: **vertrieb@hoshizaki.de**  
Fax: +49 5121 69737 - **19**

Enquiries in case of emergencies (only for working service technicians):  
Telephone +49 5121 69737 - **44** (Andre Wegner)

In the event of faults, please first check if the device is connected to the mains, then check the fault indicator on the display and consult the service manual.

**Please always note the device type, part number and serial number when making enquiries and placing orders. This information can be found on the label.**

**If you have a smartphone, we recommend sending us a photo of the label and, if in doubt, of the device and the defective part as well.**



**Technical data:**

Placement of the label:

**PRODUCT DESCRIPTION LABEL**

1 Product Number
2 Product Description
3 Model
4 Refrigerant (GWP)
5 CO2 Equivalent
6 IP Protection
7 Climate Class
8 Production Date
9 Total power / Current / Lamp power
10 Voltage - Frequency
11 Heating Element
12 System Pressure
13 Blowing Agent
14 Serial Number



MODEL RANGE	1
PRODUCT DESCRIPTION LABEL	
MODEL	
PRODUCT DESCRIPTION	
MODEL RANGE	
REFRIGERANT	
CO2 EQUIVALENT	
CLIMATE CLASS	
PRODUCTION DATE	
TOTAL POWER / CURRENT / LAMP POWER	
VOLTAGE - FREQUENCY	
HEATING ELEMENT	
SYSTEM PRESSURE	
BLOWING AGENT	
SERIAL NUMBER	

S/N: 14

HOSHIZAKI EUROPE B.V. | Registreerweg 101 | 1101 AA Amsterdam, The Netherlands

CE

**Technical data:**

Trade mark			HOSHIZAKI			
Model name			Advance K70	Advance K140	Advance F70	Advance F140
Intended use			Storage	Storage	Storage	Storage
Chilled operating temperature			X	X		
Frozen operating temperature					X	X
Multiuse cabinet						
Vertical cabinet			X	X	X	X
Counter cabinet						
Parameter	Symbol	Unit				
Energy Efficiency Class	EEC	-	C	C	D	D
Energy Efficiency Index	EEl	-	42,41	48.32	61,31	71.65
24 hour Energy Consumption	E24h	kWh	1.50	2.54	5.949	10.60
Annual Energy Consumption	AEC	kWh	547.5	926	2171.3	3869
Net volume for compartment 1	Vn or Vn1	litre	415	398	420	398
Net volume for compartment 2	Vn2	litre	-	398	-	398
Net volume for compartment 3	Vn3	litre	-	-	-	-
Net volume for compartment 4	Vn4	litre	-	-	-	-
Total Net volume	VnT	litre	415	797	420	797
Climate Class	CC		5	5	5	5
Refrigerant			R290	R290	R290	R290
Charge		kg	0.058	0.085	0.082	0.105
GWP			3	3	3	3
CO2 Equivalent		t. CO2				
Heavy-duty; This appliance is intended for use in ambient temperatures up to 40°C			X	X	X	X
Contact details:	HOSHIZAKI EUROPE B.V.					
	Address: Burgemeester Stramanweg 101 1101 AA Amsterdam, The Netherlands					
	Tel.: +31 (0)20 691 8499					
	<a href="http://hoshizaki.europe.com/">http://hoshizaki.europe.com/</a>					



## Dimensions

ADVANCE K70 & ADVANCE F70

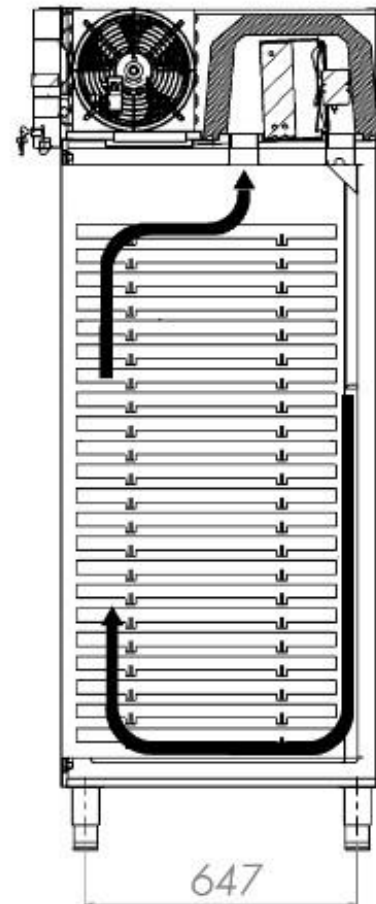
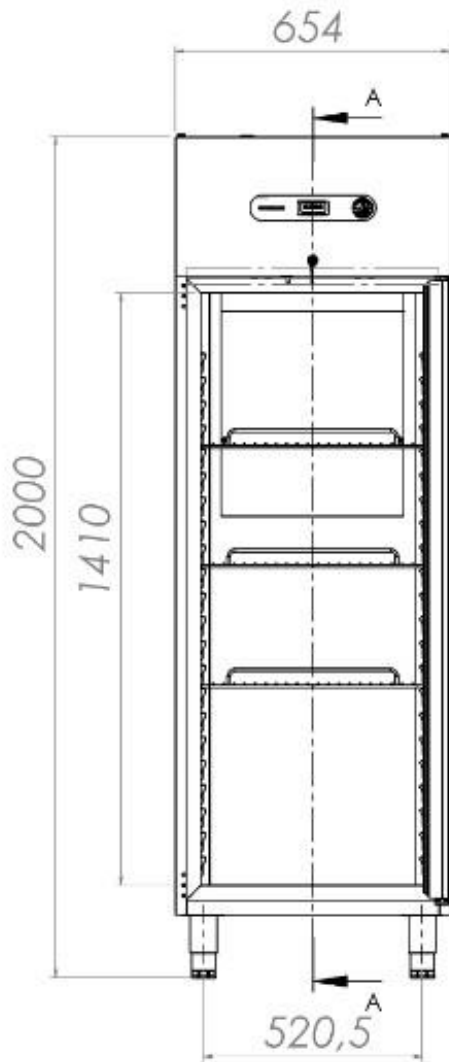

SECTION A-A

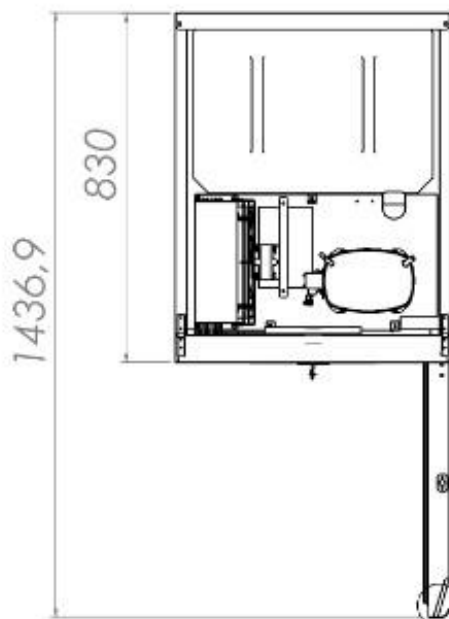



## Dimensions

ADVANCE K140 & ADVANCE F140

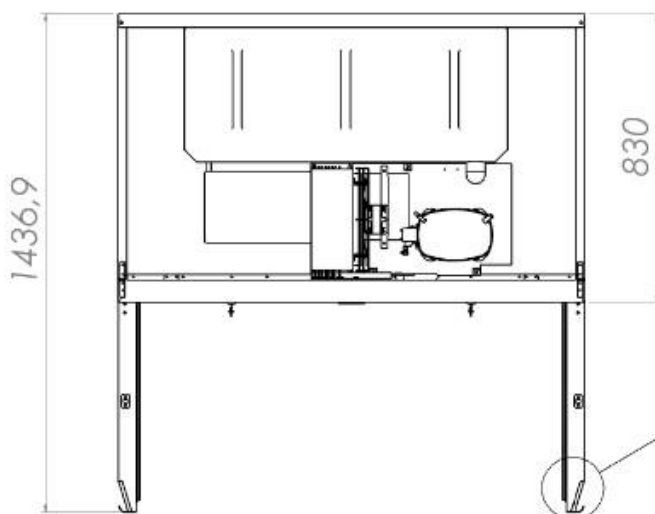
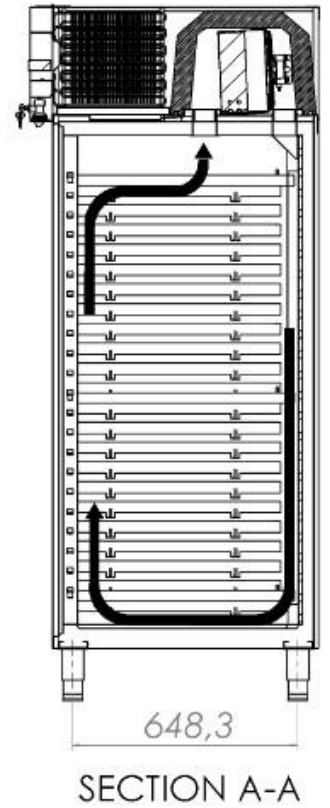
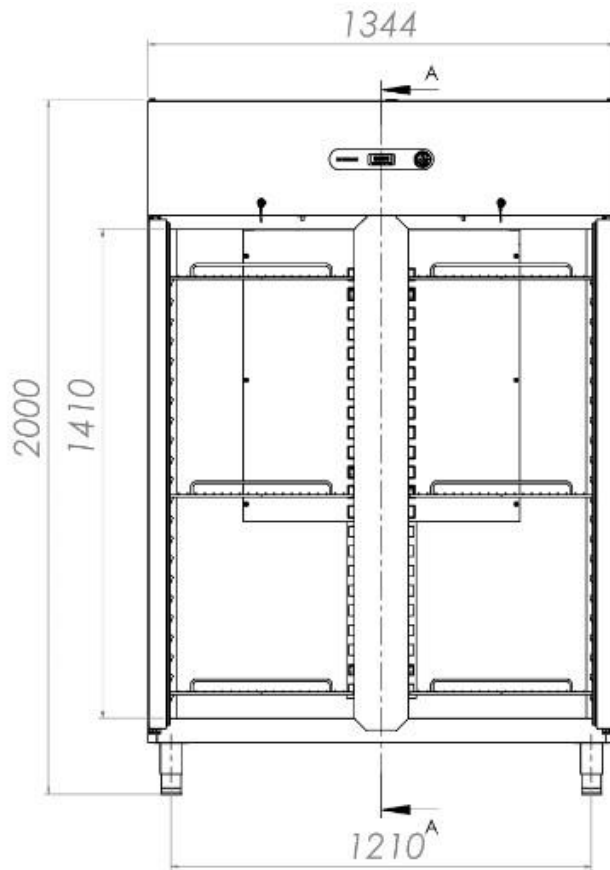



# Wiring diagram

ADVANCE K70 / ADVANCE K140 MODELS WIRING DIAGRAM  
EVCO EV3B22N7 Model Digital Thermostat

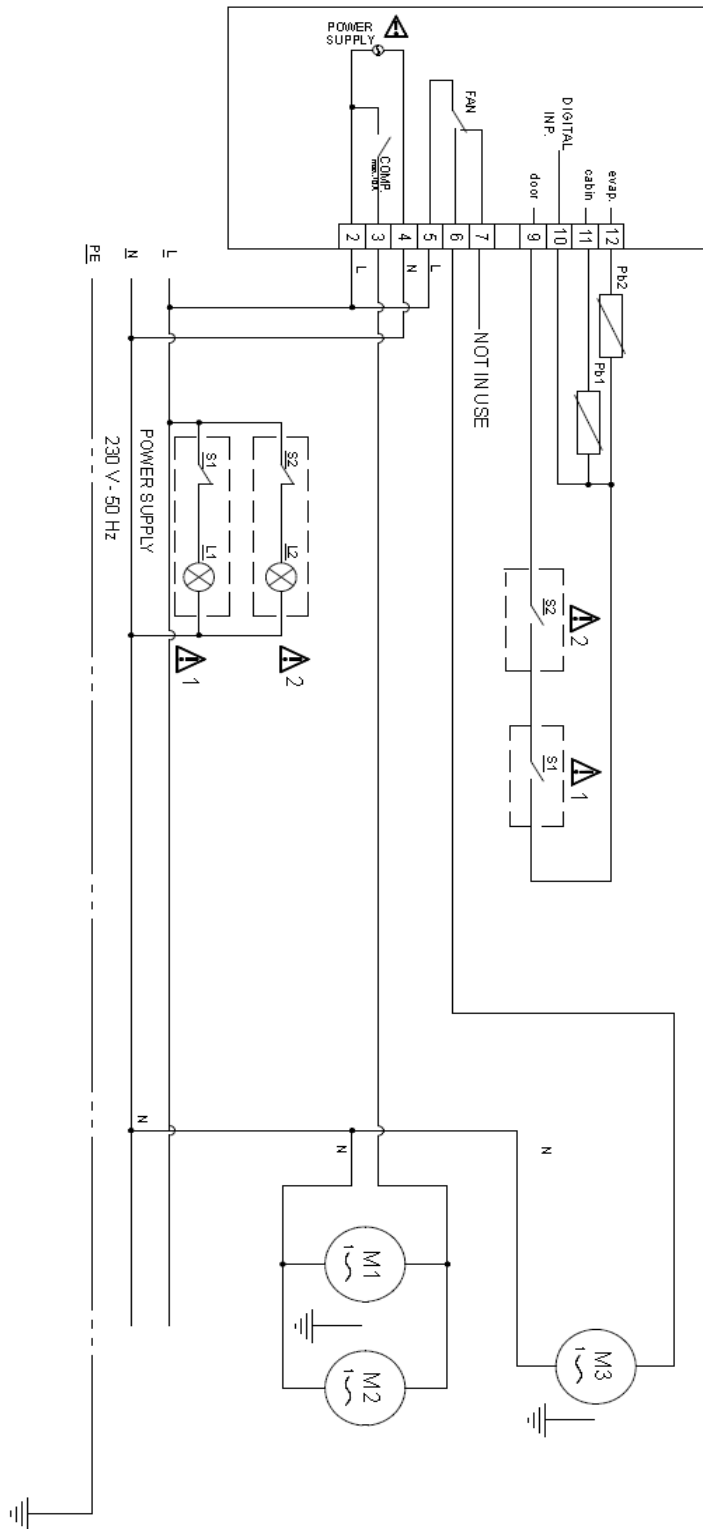

DESCRIPTIONS	
△: Available only on ADVANCE K140	
S1: Door Switch 1	L1/L2: Led light
S2: Door Switch 2	M1: Compressor
Pb1: Cabin Probe	M2: Condenser Fan
Pb2: Evaporator Probe	M3: Evaporator Fan



Wiring diagram

ADVANCE F70 / ADVANCE F140 MODELS WIRING DIAGRAM  
[EVCO EV3B23N7 Model Digital Thermostat

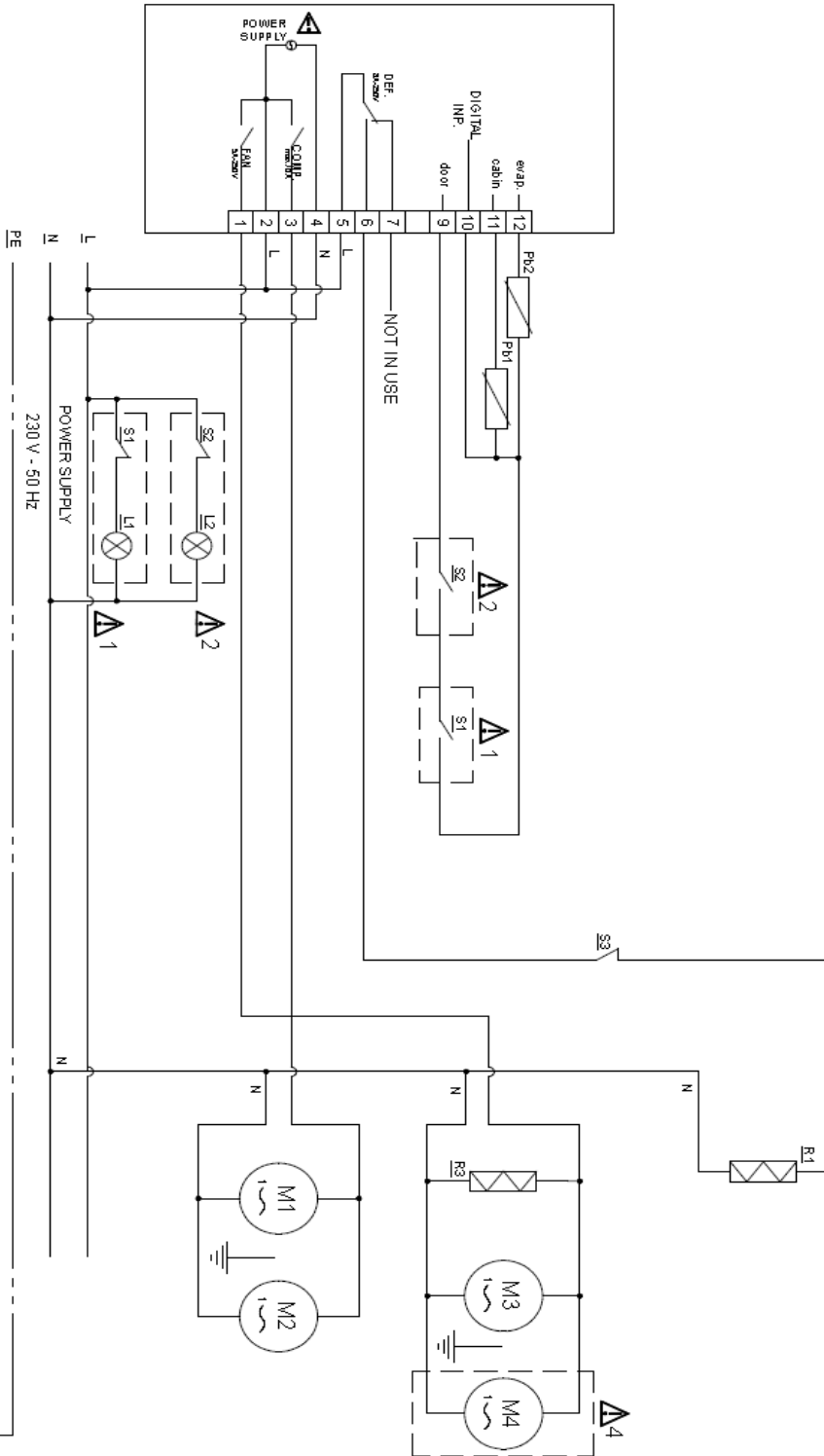

DESCRIPTIONS

- △2 △4 Available only on ADVANCE F140
- S1: Door Switch 1
- S2: Door Switch 2
- S3: Thermal Protector
- Pb1: Cabin Probe
- Pb2: Evaporator Probe
- R1: Defrost Heater
- R3: Door frame cable heater
- L1/M2: Led light
- M1: Compressor
- M2: Condenser Fan
- M3/M4: Evaporator Fan



## Mounting and connecting the controller

Mounting with spring clips:

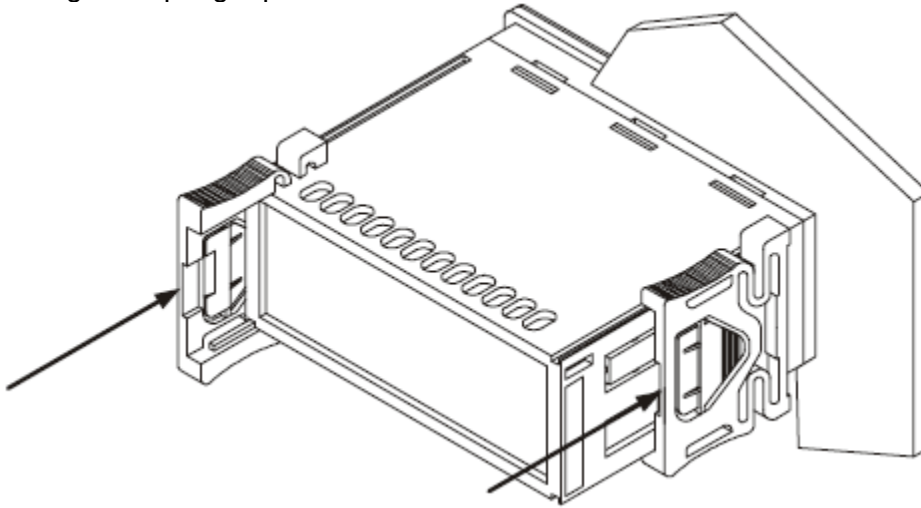

## Cooling system

Standard cooling system

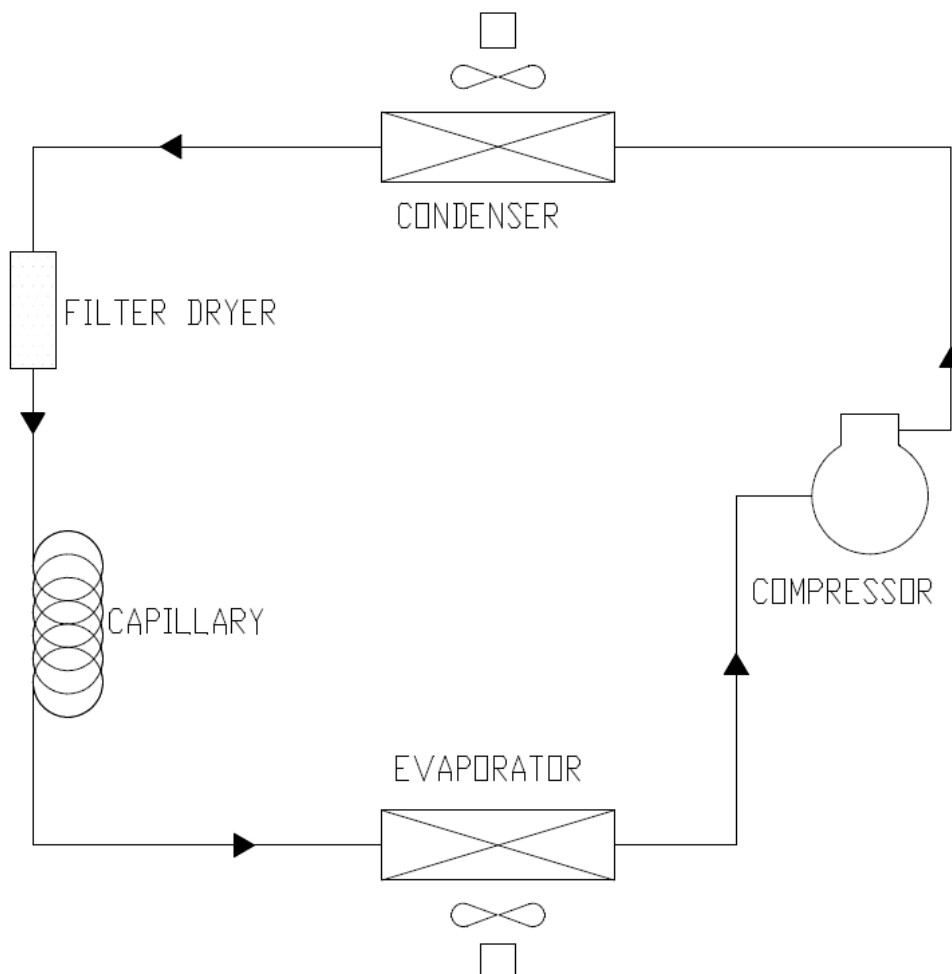



# EU Declaration of Conformity SUR / SUF – EG



**HOSHIZAKI EUROPE B.V.**



## EC DECLARATION OF CONFORMITY

**Manufacturer** : ÖZTİRYAKİLER MADENİ EŞYA SAN. VE TIC. A. Ş.  
**Address** : Cumhuriyet Mah. Eski Hadımköy Yolu Cad. No:8, Büyükçekmece / İstanbul – TURKEY  
**Phone** : +90 212 886 78 00

We declare under our responsibility that the product(s):

<b>Product Name:</b>	<b>Model No:</b>
Upright refrigerated cabinet type	ADVANCE K70 and ADVANCE K140
Upright freezer cabinet type	ADVANCE F70 and ADVANCE F140
<b>Brand Name</b>	<b>: HOSHIZAKI / GRAM</b>

To which this declaration relates is in conformity with the following standard(s) or other normative document(s):

Directives/Regulations:

- 2014/35/EU Low Voltage Directive
- 2014/30/EU Electromagnetic Compatibility Directive
- 2006/42/EC Machinery Directive
- 2015/1095/EC Eco Design Regulation
- 2009/125/EC Eco design of energy-related products
- 2011/10/EC FCM directive
- 2015/863/EU RoHS Directive (amending Annex II to directive EU-2011/65/EU)

Harmonized Standards:

- EN 12100:2011
- EN/ISO 22041:2019
- IEC 60335-1:2010, AMD1:2013, AMD2:2016
- IEC 60335-2-89:2019
- EN 60335-1:2012+A11:2014+A13:2017+A1:2019+ A14:2019+A2:2019
- EN 60335-2-89:2010+A1:2016+A2:2017 EN 62233:2008
- CISPR14-1:2020, CISPR14-2:2020
- IEC 61000-3-2:2018+AMD1:2020
- IEC 61000-3-3:2013+AMD1:2017
- Safety EMC :IEC 60335-1:2020

**Authorized Representative located within the Community:** Hoshizaki Europe B.V.  
**Address:** Burgemeester Stramanweg 101, 1101 AA Amsterdam, The Netherlands

Amsterdam, 1 June 2022  
 Place and date of issue

  
 Signature:  
 Kazuya Jinno (Managing Director)

**Hoshizaki Europe B.V.**  
 Burgemeester Stramanweg 101 | 1101 AA Amsterdam | The Netherlands  
 Tel. +31 (0)20 6918499 | Fax +31 (0)20 6918768 | [www.hoshizaki-europe.com](http://www.hoshizaki-europe.com)  
Commercial Register: Amsterdam 13.238.845 (VAT No. NL801295623.R.01)  
 Our Terms and Conditions ([www.hoshizaki-europe.com](http://www.hoshizaki-europe.com))





# UKCA Declaration of Conformity SUR / SUF –EG



HOSHIZAKI EUROPE B.V.

UK  
CA

## UK CONFORMITY ASSESSED

Manufacturer : ÖZTİRYAKİLER MADENİ EŞYASAN. YETİC. A.Ş.  
 Address : Cumhuriyet Mah. Eski Hadımköy Yolu Cad. No:8, Büyükkçekmece / İstanbul –TURKEY  
 Phone : +90 212 886 78 00

We declare under our responsibility that the product(s):

Product Name:	Model No:
Upright refrigerated cabinet type	ADVANCE K70 and ADVANCE K140
Upright freezer cabinet type	ADVANCE F70 and ADVANCE F140

Brand Name : HOSHIZAKI / GRAM

To which this declaration relates is in conformity with the following standard(s) or other normative document(s):

Directives/Regulations:

- 2014/35/EU Low Voltage Directive
- 2014/30/EU Electromagnetic Compatibility Directive
- 2006/42/EC Machinery Directive
- 2015/1095/EC Eco Design Regulation
- 2009/125/EC Eco design of energy-related products
- 2011/10/EC FCM directive
- 2015/863/EU RoHS Directive (amending Annex II to directive EU-2011/65/EU)

Harmonized Standards:

- EN12100:2011
- EN/ISO 22041:2019
- IEC 60335-1:2010, AMD1:2013, AMD2:2016
- IEC 60335-2-89:2019
- EN 60335-1:2012+A11:2014+A13:2017+A1:2019+ A14:2019+A2:2019
- EN 60335-2-89:2010+A1:2016+A2:2017 EN 62233:2008
- CISPR14-1:2020, CISPR14-2:2020
- IEC 61000-3-2:2018+AMD1:2020
- IEC 61000-3-3:2013+AMD1:2017
- Safety EMC :IEC 60335-1:2020

UK Authorized Representative: Hoshizaki Europe B.V.  
 Address: The Technology Centre London Road, Swanley, Kent BR8 7AG, The United Kingdom

Swanley, 1 June 2022  
 Place and date of issue

Signature:  
 Simon Frost  
 Branch Manager UK and Ireland, Hoshizaki Europe B.V.

Hoshizaki Europe B.V.  
 Burgemeester Stramanweg 101 | 1101 AA Amsterdam | The Netherlands  
 Tel. +31 (0)20 6918499 | Fax +31 (0)20 6918768 | www.hoshizaki-europe.com  
 Commercial Register Amsterdam 33.288.845 | VAT No. NL801295.683.B01  
 Our Terms and Conditions (www.hoshizaki-europe.com)