



F59/511 - IMC MF10 Free-standing Vegetable Peeler - 3 Phase - W 481 mm - 0.37 kW

The high-output, versatile MF10 (3PH) can be used to wash, peel and spin a range of food - making it an ideal addition for medium to large kitchens.

- ✓ Able to peel up to 296kg of vegetables per hour - in 10kg batches.
- ✓ Versatile - can be used to peel and wash veg and mussels, and spin salad.
- ✓ Interlocking lid and door ensure safe operation.
- ✓ Perspex viewing pane allows you to monitor the peeling progress.
- ✓ Adjustable timer ensures accurate, repeatable peeling times.
- ✓ Modular construction facilitates easy maintenance.
- ✓ Thicker peeling plate delivers longer operating life.
- ✓ Suitable for medium to large kitchens with three-phase power supply.

Specifications

Summary

Brand	IMC
Range	MF Multi-Functional Peeler
Power Type	Electric
Unit Type	Free-standing
Available in UK Only	No
UK Warranty	2 Years Parts and Labour Warranty
Export Warranty	Contact your local dealer
Mounting	Free-standing
GTIN	5056105198635

Power and Performance

Total Power kW	0.37
HP	0.5
IP Rating	IP55

Key Specifications

Operator Safety	Interlocks
Timer	Yes
Drain Location	Rear and under
Airbreak	Yes

Capacity

Capacity Kg per Hour	296
-----------------------------	-----

Weights and Dimensions

Unit Height (External) mm	1105
Unit Width (External) mm	481
Unit Depth (External) mm	633
Net Weight Kg	50.5

Supply Connections

Requires Installation	Yes
Requires Electrical Supply	Yes
UK 3 Pin Plug	No
Requires Hardwiring	Yes
Motor Rating Watts	370
Three Phase Amps	1.2
Three Phase Voltage	400
Water Connection Pressure Bar	2.7-3.8 [40-55 psi]
Drain Connection	38mm
Water Connection	12mm

Shipping

Packed Weight Kg	55.55
Packed Height cm	117
Packed Width cm	68
Packed Depth cm	51

Available Accessories

E72/011	Sink Skip - Stainless Steel - for MF10/MF10L/MF15/MF15L/VQ Peeler
S58/062	Inlet Hose Kit for MF10/MF10L/MF15/MF15L Vegetable Peeler
S59/164	Carborundum Peeling Plate for MF10/MF10L/MF15/MF15L Vegetable Peeler
S59/166	Onion Peeling Plate for MF10/MF15 Vegetable Peeler
S59/168	Knife Peeling Plate for MF10/MF15 Vegetable Peeler
S59/170	Salad Spinning Basket for MF10 Vegetable Peeler
S59/173	Washing Plate for MF10/MF15 Vegetable Peeler
S59/175	Mussel Washing Plate for MF10/MF15 Vegetable Peeler

Technical Picture

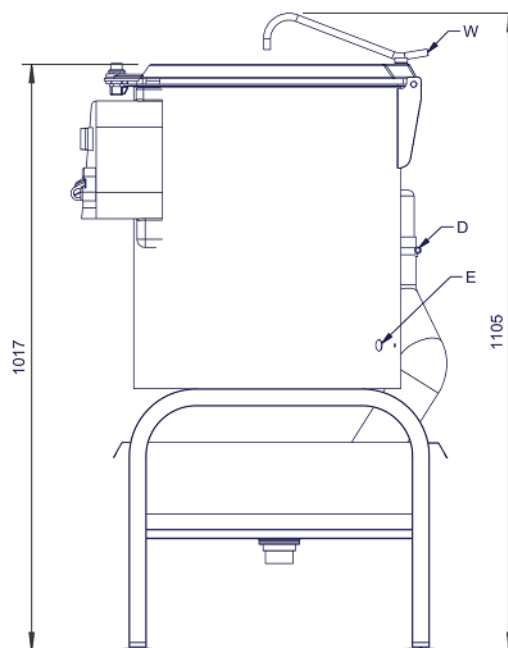
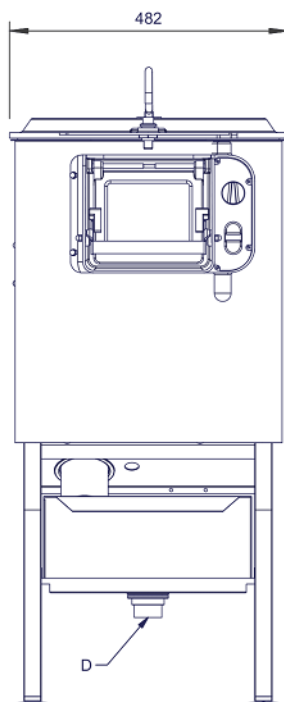
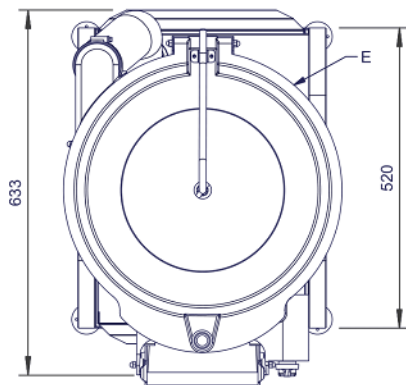



Lincat Limited

Whisby Road,
Lincoln, LN6 3QZ,
United Kingdom

Company No: 2175448

A member company of



Customer Care

Tel: +44 1522 875500
Email: care@lincat.co.uk

Export Customers

Tel: +44 1522 875536
Email: export@lincat.co.uk

Opening Hours

Monday – Friday:
8.30am – 5pm