

RF50C00024

# READY BLAST CHILLER AND FREEZER

**EN** UTILISATION AND MAINTENANCE MANUAL



## **Congratulations for having acquired our equipment!**

Work has become much more simple thanks to the intuitive graphics of the user interface, designed to make easier the access to the functions, with a representation that is immediately identifiable and that favours the interaction between the user and the device.

In one single machine, a technology concentration that allows it to perform several and complementary activities, always seeking the best efficiency in food processing: therefore it can be immediately operational without the need to perform complex procedures, thanks to 300 work processes and cycles.

This manual has the objective of providing all the necessary information for the correct use of the equipment and the execution of an efficient maintenance.

Before starting any operation it is necessary to carefully read the instructions contained herein, because they offer indispensable indications concerning the safety status of the equipment.

<b>SAFETY WARNINGS.....</b>	<b>5</b>
Safety warnings before utilisation.....	5
Correct use of the equipment.....	5
In case of equipment malfunctioning.....	6
Risks associated to the use of the equipment.....	6
<b>LEARNING ABOUT THE EQUIPMENT.....</b>	<b>7</b>
What is the use of a temperature-based chiller?.....	8
Why defrost in a controlled manner? .....	8
Load the equipment correctly .....	8
Achieve better results and work safely .....	10
How to use the needle probe .....	10
Starting and shutting off .....	11
Keypad lock and unlock.....	11
Initial settings (Language and Date/Time).....	11
<b>UTILISATION.....</b>	<b>11</b>
Positive Chilling with automatic or manual cycles.....	16
Positive Preservation .....	17
Saving the completed Chilling cycle .....	17
Freezing with automatic or manual cycles .....	18
Positive Preservation .....	19
Saving of the completed Positive Chilling cycle.....	19
NEEDLE HEATING .....	20
COOLING .....	21
CONTINUOUS CYCLE .....	22
FIRMWARE UPDATE .....	23
Cleaning of the equipment chamber.....	24
Touch screen .....	24
<b>MAINTENANCE.....</b>	<b>24</b>
Cleaning of the grilles.....	25
Long shutdowns.....	25
<b>POST SALES ASSISTANCE .....</b>	<b>27</b>
<b>ALARMS .....</b>	<b>29</b>
<b>DISPOSAL AND END OF SERVICE LIFE.....</b>	<b>31</b>



## SAFETY WARNINGS BEFORE UTILISATION

- Any utilisation and cleaning performed not in compliance with that specified and foreseen in this booklet is considered as incorrect and may cause damages, injuries or fatal incidents, will void the warranty and exempt the manufacturer from any responsibility.
- The utilisation is reserved only for qualified and trained personnel, who have attended periodical formation courses.
- Do not approach electrical components with wet hands or without shoes.
- It is absolutely forbidden to tamper with or remove the safety devices provided (protective grilles, safety warning labels, etc...). The manufacturer declines from any responsibility should the instructions above not be complied with.
- Do not insert screwdrivers or other tools between the guards (fan guards, evaporators, etc.).
- To ensure optimum functionality of the compressor and evaporator unit, never obstruct the suitable air intakes.
- In case of fire, do not use water, keep CO<sub>2</sub> extinguishers available (carbon dioxide) and cool the motor installation compartment as quickly as possible.

## CORRECT USE OF THE EQUIPMENT

- This equipment is considered an agrifood machine (CE Regulation no. 1935/2004), intended for the processing of food products in industrial and professional kitchens. It is not suitable for the preservation of pharmaceutical or chemical products, or any other non-food product.
- Specifically:
  - Showcases (+2/+8°C): are adequate for the preservation and exposure of bottles, tins, etc.
  - Refrigerators (-2/+8°C): are adequate for the preservation for short periods of fresh foodstuff and pre-cooked prepared foods, and also for the refrigeration of beverages
  - Conservators (-22/-15°C): are adequate for the preservation during short periods of deep frozen products
  - Chillers (+90/+3°C) (+90/-18°C): are adequate for the quick lowering of foodstuff temperature, in order to keep unchanged its organoleptic properties
  - Leavening control (-15/+40°C) (-2/+40°C): are adequate for the production and preservation of pastries.
- With the purpose of achieving the best equipment performance, it is necessary to observe the following indications:
  - Do not place inside the equipment hot food (except in the case of chilling functions) or open liquids, live animals, other objects or corrosive products.
  - Pack or protect food with other means, particularly if containing aromas or spices.
  - Position the foodstuff inside the equipment without disturbing the air circulation, do not place paper, cardboard, cutting boards, etc. over the grilles, which may obstruct the air flow.
  - Avoid as much as possible frequent and prolonged door opening.
  - If the door has been opened, wait some time before opening it again.
  - Place the foodstuff gradually, starting from below and going up; to remove the foodstuff work from top to bottom. The maximum load (evenly distributed) per tray or grille is equal to 65 kg.
- The refrigeration equipment is built and designed with adequate features to guarantee the safety and health of the users, avoiding the presence of dangerous edges, sharp surfaces or elements that extend beyond the main volume. Its stability is ensured even with open doors, however it is forbidden to hang on the doors.
- Failure to comply with these rules may cause damage and injuries, also fatal, and will void the warranty.

# SAFETY WARNINGS

## IN CASE OF EQUIPMENT MALFUNCTIONING...

- If the equipment does not work properly or if functional or structural problems are noticed, disconnect it from the electrical and water source and get in contact with an assistance centre authorised by the manufacturer, and do not attempt to repair it yourself. The use of original spare parts is recommended. The manufacturer declines from any responsibility for the use of non-original spare parts.
- To be sure that the equipment is maintained in perfect use and safety conditions, we recommend the execution of a maintenance and inspection service by an authorised assistance centre, at least once a year.



## RISKS ASSOCIATED TO THE USE OF THE EQUIPMENT

- **RISKS DUE TO DISPLACEMENT ON WHEELS:** if the equipment is supported by wheels, be careful during displacements to avoid pressing the equipment strongly, because it may tip or get damaged, pay attention also to eventual unevenness of the rolling surface. The equipment supported on wheels cannot be levelled, therefore be sure that the supporting surface is perfectly horizontal and flat. Always lock the wheels with the devices provided.
- **RISKS DUE TO MOBILE ELEMENTS:** the only mobile element present is the fan, but it presents no risk because it is protected by a protective grille fastened with bolts.
- **RISKS DUE TO LOW/HIGH TEMPERATURES:** warning labels indicating "DANGER DUE TO TEMPERATURE" are affixed close to the dangerous zones with low/high temperatures.
- **RISKS DUE TO ELECTRICAL POWER:** the risks of an electrical nature are solved by the design of the electrical installation according to the CEI EN 60335-1 standard. Appropriate warning labels indicating "high voltage" identify the zones with dangers of an electrical nature.
- Noise level less than 70 dB.

# LEARNING ABOUT THE EQUIPMENT

## Positive chilling

- It is used to quickly bring the temperature at the core of the product to +3°C and reduces the natural evaporation of the product while maintaining its humidity, avoiding bacterial proliferation after cooking.
- The positive chilling function means being able to plan preparations in advance, to increase productivity, to keep flavour, colour, aroma and weight unaltered and to remove the risks of intoxication and waste.
- Thanks to the perfect control of the air and temperature in the room, all the organoleptic characteristics are kept intact.

## Negative chilling

- Allows a quick temperature drop in the core of the product to -18°C, keeping intact the product structure and consistency.
- Negative chilling allows the purchasing of products at their best in terms of freshness, ripeness and availability on the market while allowing all their qualities to be kept intact.
- Thanks to a controlled air flow at -40°C, it is possible to freeze in time the quality of a fresh product.

p. 20

- Recipe book



- Defrost

- Continuous Cycle

- Cooling

- Settings

# LEARNING ABOUT THE EQUIPMENT

## What is the use of a temperature-based chiller?

The chiller is an equipment that decreases very quickly the temperature of the introduced foodstuff, either fresh or already cooked. Fresh or recently cooked food have in fact the best organoleptic and flavour quality; however, if not consumed immediately, it loses its initial qualitative characteristics with the passage of time, and a multiplication of micro-organisms potentially dangerous for humans will take place.

**Positive Chilling** is performed when the food is not consumed immediately after preparation, by reducing the product temperature within 90 minutes until it reaches +3°C at its core. After this, the product must be conserved under refrigeration at a temperature of 0/+3°C, therefore conserving its quality for up to 5 days.

**Negative Chilling** is performed to keep all the organoleptic characteristics of the food intact. The chiller reduces the product temperature until it reaches -18 degrees in the core. Then the product must be conserved in a freezer at a constant temperature of -20 degrees and can be consumed even after 3/18 months, according to the product, provided the cooling chain standards are complied with.

Regular refrigerators and freezers, as opposed to a chiller, don't have the features to quickly decrease the initial product temperature, as a result the later will be damaged at the organoleptic and flavour levels.

## Why defrost in a controlled manner?

With the **Defrosting** function, this equipment takes the frozen products to a positive temperature in a controlled and quick manner, in compliance with the HACCP standards: this means always remaining below the temperatures at which the bacteria flora reproduces in an exponential progression.

Additionally, the cooking of food defrosted in a controlled manner brings advantages when compared to the cooking of an already cooked food, starting from an initial frozen condition, and also reduces the risk of having parts of the food not completely cooked.

## Load the equipment correctly

The dishes are placed on a single layer, in containers:

- uncovered;
- suitable for food use;
- resistant to the temperatures reached by the chilling and slow cooking cycles;
- with low edges (maximum 4.5 cm).

The recipients must be evenly and uniformly distributed inside the cell.

The correct positioning of the containers allows free air circulation inside the cell: avoid obstructing the ventilation fans and overloading the equipment beyond the permitted limits.

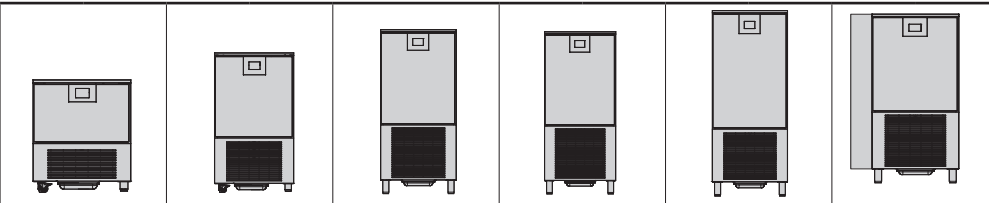
																									
Model		051R		051S		081R		081S		120R		120S		121R		121S		161R		161S		122R		122S	
Capacity chill in 120'	+65>+10°C EN17032	kg	20	25	25	35	50	60	50	60	70	75	70	80											
Capacity freez. in 270'	+65>-18°C EN17032	kg	10	15	15	20	30	40	30	40	40	50	45	55											
Type of pans/grilles			GN1/1 600x400		GN1/1 600x400		GN1/1 600x400		GN1/1 600x400		GN1/1 600x400		GN1/1 600x400												
Pan capacity GN 1/1 - EN1	H 20 mm	no.	10	10	18	18	22	22	24	24	28	28	44	44											
	H 40 mm	no.	6	6	12	12	14	14	16	16	18	18	28	28											
	H 65 mm	no.	5	5	9	9	11	11	12	12	14	14	22	22											



## READY S

### EN17032

+65°C > +10°C / +65°C > -18°C

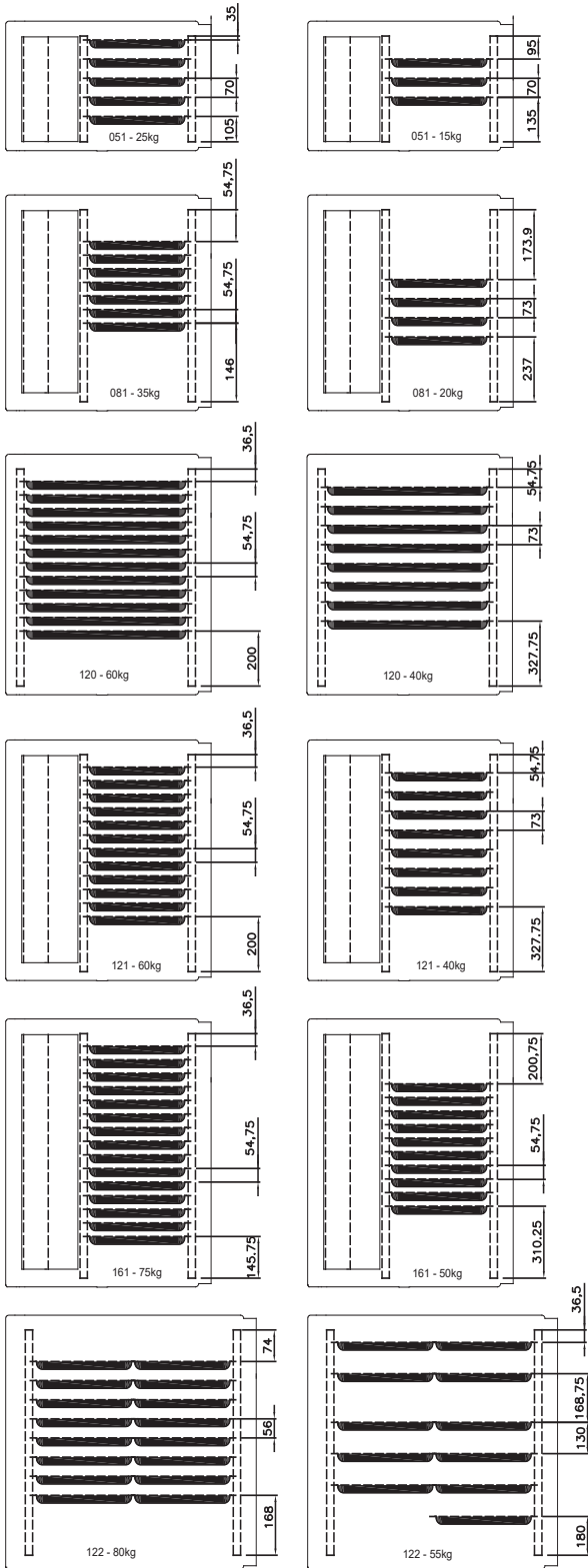

## READY R

### EN17032

+65°C > +10°C / +65°C > -18°C

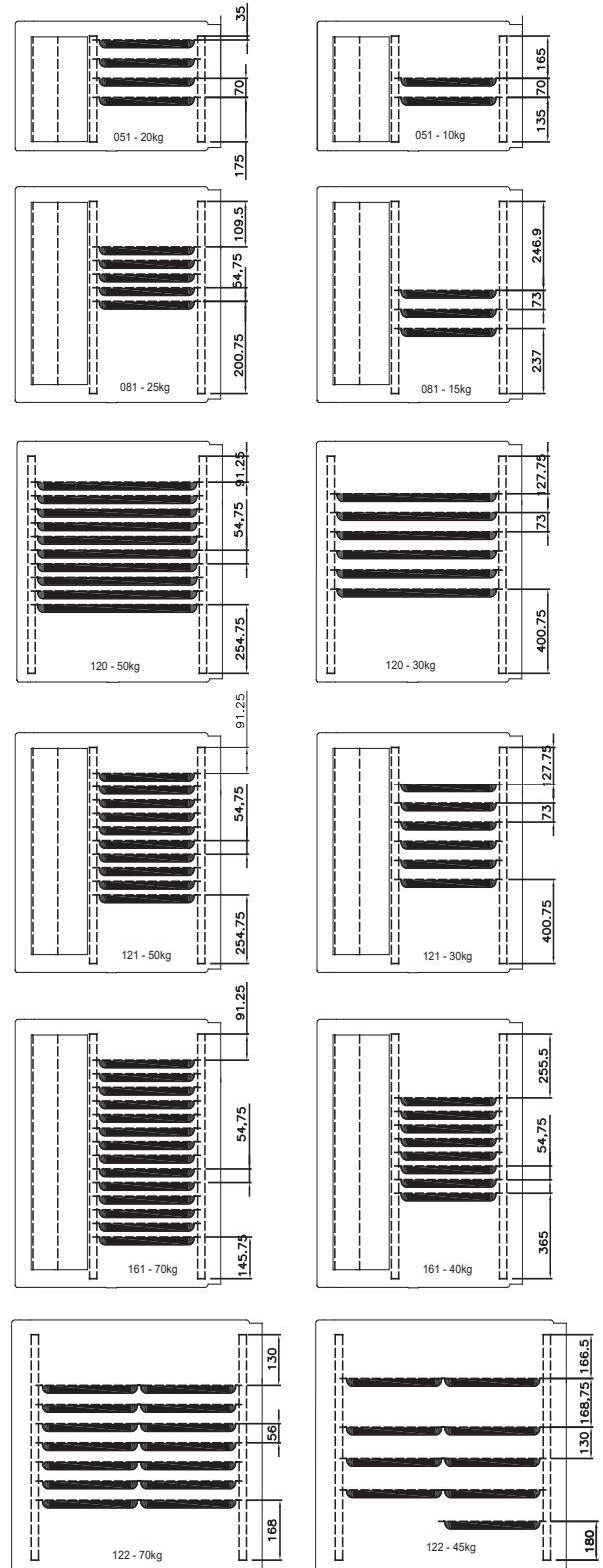

# LEARNING ABOUT THE EQUIPMENT

## Achieve better results and work safely

- Keep the air inlets of the motor compartment free of objects and clear of dust;
- wash periodically or replace the filter located behind the air inlets of the motor compartment;



*For more information about how to remove the filter consult chap. Cleaning of the grilles on page 20.*

- arrange the foods to be chilled or cooked as explained in the previous chapter;
- close the doors tightly during every work cycle;
- always keep the defrost water discharge hole unobstructed;
- avoid opening the doors during the positive or negative chilling/slow cooking cycles;
- carry out regularly the ordinary maintenance as specified in the dedicated section;



*For more information about how to remove the filter consult par. MAINTENANCE on page 19.*

- in the case of cooking with grilles of particularly fatty foods (for example poultry), insert a pan on the bottom of the chamber to collect the greases that could drip down from the food;
- do not use easily flammable foods or liquids (e.g. alcohol) during cooking.

## How to use the needle probe

The needle probe, during a chilling or cooking cycle, detects the temperature at the "core" of the food: when it reaches the value set by the user or in the factory, it means that the food is chilled (**Chilling** function) or cooked (**Slow Cooking** function).

The needle probe is inserted deeply into the food to be chilled/cooked: be sure that the needle tip reaches the "core" of the food, this means its most internal point, without extending out. Be careful not to insert it in points with much grease or next to bones.

If the food thickness is too small, insert the probe parallel to supporting surface.

It is recommended to keep the probe always clean and hygienic.





**HANDLE THE PROBE CAREFULLY AS IT IS POINTED AND, AFTER USE IN COOKING, REACHES HIGH TEMPERATURES.**

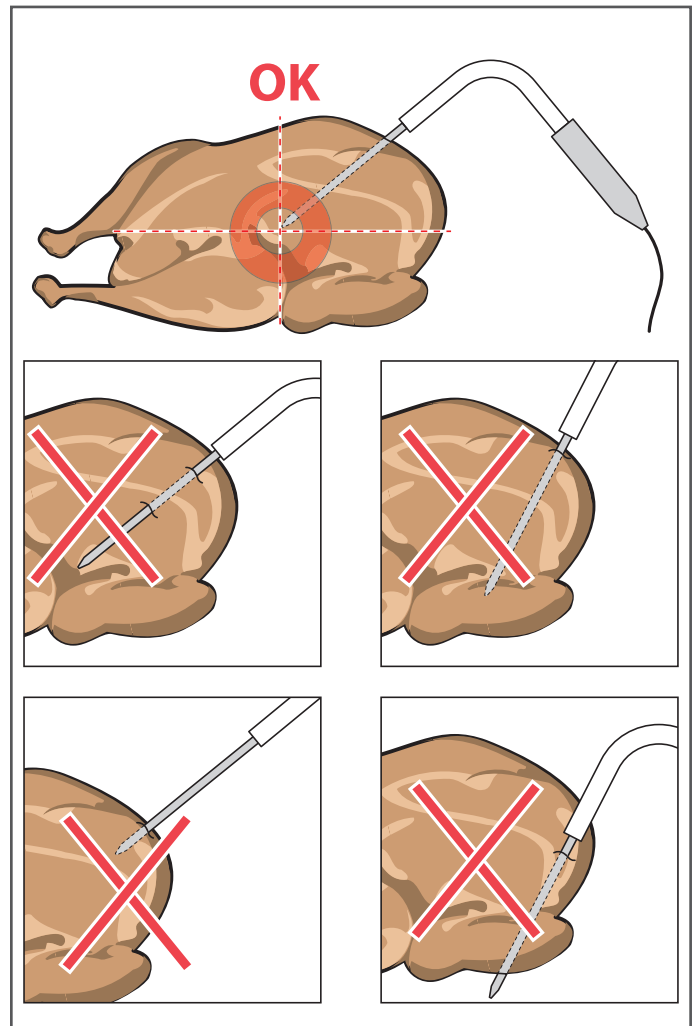
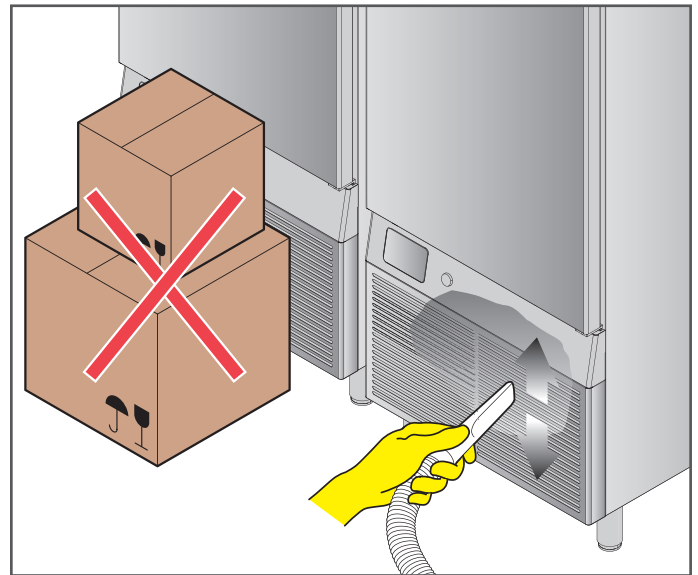

*The probe can be heated to facilitate its extraction from frozen foods, see page 17.*



## Starting and shutting off

- 1 To turn on the equipment, tap the  **ON/OFF** key: the main screen appears.
- 2 At the end of the work activity, to turn off the equipment, from the main screen, tap the  **ON/OFF** key.

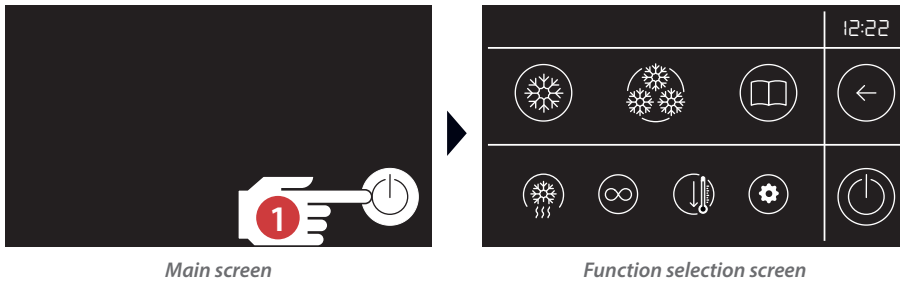

Main screen

Function selection screen

## Keypad lock and unlock



Keypad locked

Keypad unlocked

After a few minutes of inactivity, the keypad lock is automatically activated, which guarantees inappropriate accidental stops of a cycle that has started.

- 1 To release the keypad, tap the **padlock** on the display; the sound of three beeps one after another indicates that it has been unlocked.

## Initial settings (Language and Date/Time)





- 1 Tap the **Settings** key: the Settings screen appears

- 2 Set the display **language** for all screens by tapping the **Select Language** key.

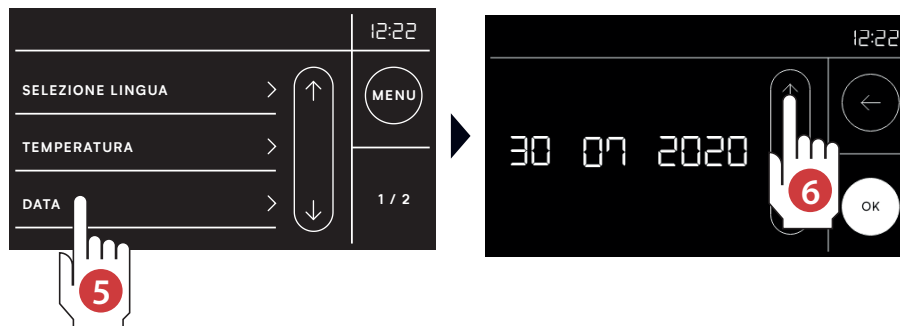
- 3 Tap the relevant language
- 4 Confirm with the key 



- 5 Set the **current date** by tapping the **Date** key.

- 6 Use the and keys  and  to set the data and confirm with 

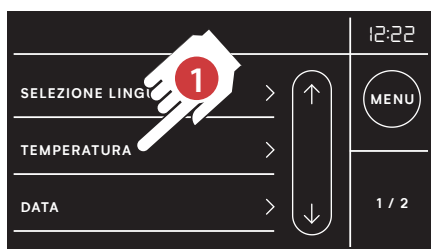

**1** Then tap the **Temperature** key

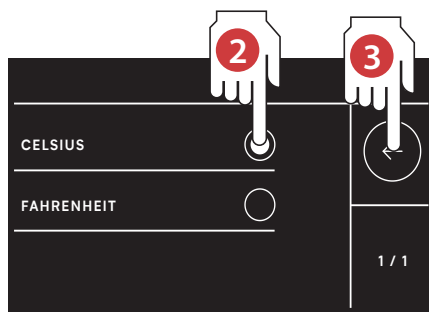

**2** Set the desired unit of measurement

**3** confirm with the key 

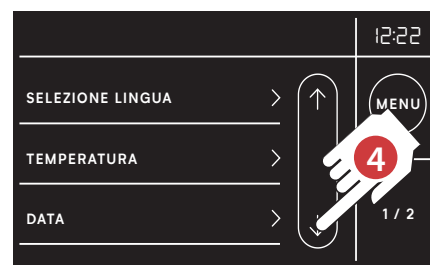

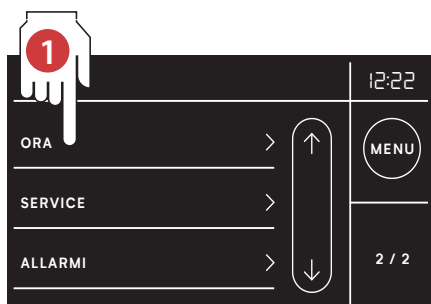

**4** Scroll through the settings page

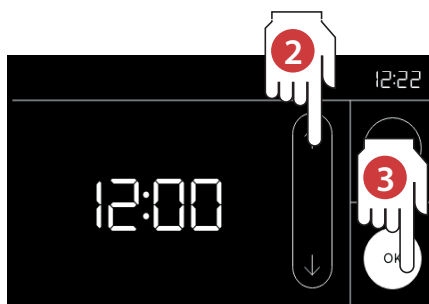

**1** Select the **Time** key to set the current time



**6** Use the and keys  and  to set the data and confirm with



The Positive Chilling function is used to quickly bring the temperature at the core of the product, fresh or already cooked, to +3°C.



*Before starting a Positive Chilling cycle +3°C, it is always preferable to pre-cool the cell.*

## Positive Chilling with automatic or manual cycles

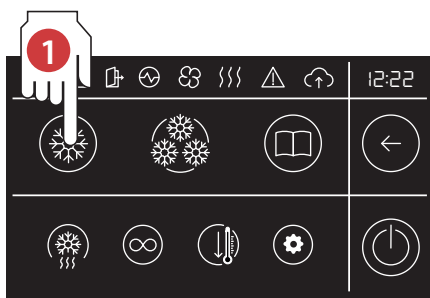

**1** Select the **Chilling** cycle from the main screen by tapping the corresponding icon.

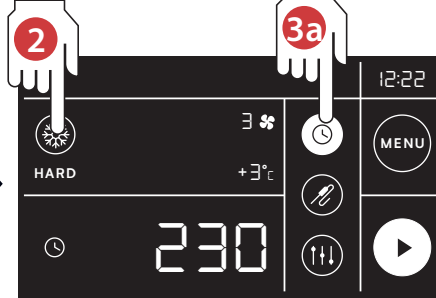

**2** Select the SOFT icon to switch to HARD mode

**3a** Select the cycle to be used (it will turn white):

- **time:** automatic timed cycle
- **needle:** automatic cycle, with core probe

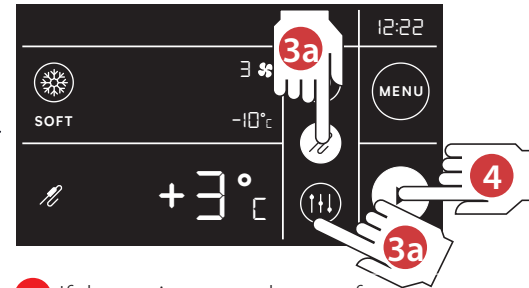

**4** If the settings are adequate for your requirements, start the positive chilling cycle by pressing the key



**3b** Tapping the **MANUALE** key it is possible to check the settings of the selected cycle.

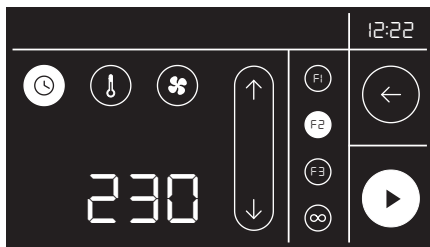

**5** The changes will only take effect for the cycle that will be performed (the changes are not permanent and are cancelled by exiting the program).

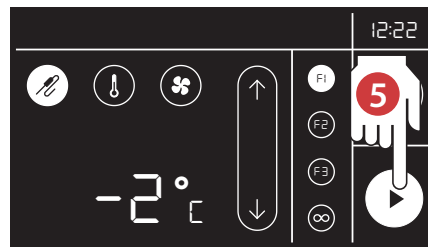

Current room temperature



Time elapsed from start and time left to the end of the recipe



Current core temperature



**6** The recipe ends when the set time expires (if the cycle is timed) or when the required core temperature is reached (if the cycle includes a core probe). To end the cycle early, tap the **STOP** key.

At the end of the **Positive Chilling** cycle, it automatically switches to **Positive Preservation** mode.



*Cycles that have finished and moved on to the preservation phase as expected can be saved in the My Recipes section.*



## Positive Preservation



During the **Positive Preservation** phase (which automatically follows each **Chilling** cycle) the cell temperature is kept at +2°C.

Pressing the **STOP** key ends the cycle.

When a cycle is not performed correctly due to a power failure or other reasons, the equipment restarts and returns to the main menu.

## Saving the completed Chilling cycle

Cycles that have finished and passed on to the preservation phase as expected can be saved.



**1** Save the finished cycle by tapping the **add recipe**  key.

**2** The parameters set for the cycle that has just ended will appear on the screen. Tap the OK key to save the cycle, or exit with the key .

**3** Tap the position at which to save the recipe: confirm the selected position with **OK** or exit with .



The cycles of my recipes saved from a CYCLE PERFORMED must only be used with the same type of food and of the same size as the cycle performed.

The purpose of the Negative Chilling cycle is to rapidly bring the fresh or cooked product core temperature to -18°C.



*It is always best to pre-cool the cell before starting a Negative Chilling -18°C cycle.*

## Freezing with automatic or manual cycles

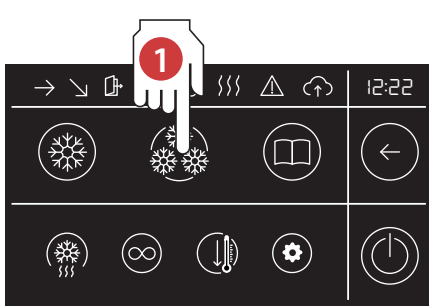

**1** Select the **Chilling** cycle from the main screen by tapping the corresponding icon.

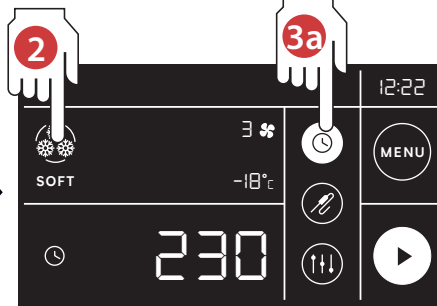

**2** Select the SOFT icon to switch to HARD mode

**3a** Select the cycle to be used (it will turn white):

- **time:** automatic timed cycle
- **needle:** automatic cycle, with core probe

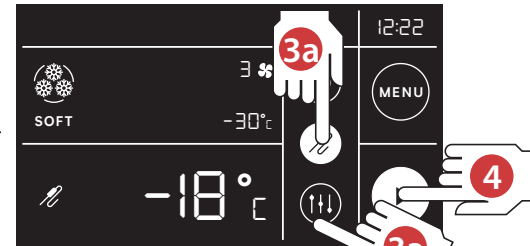

**4** If the settings are adequate for your requirements, start the positive chilling cycle by pressing the key



**3b** Tapping the **MANUALE** key it is possible to check the settings of the selected cycle.

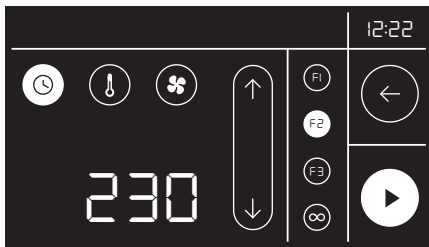

**5** The changes will only take effect for the cycle that will be performed (the changes are not permanent and are canceled by exiting the program).



Current room temperature



Time elapsed from start and time left to the end of the recipe



Current core temperature

**6** The recipe ends when the set time expires (if the cycle is timed) or when the required core temperature is reached (if the cycle includes a core probe). To end the cycle early, tap the **STOP** key.

At the end of the **Freezing** cycle, it automatically switches to **Negative Preservation** mode.



*Cycles that have finished and moved on to the preservation phase as expected can be saved in the My Recipes section.*



## Positive Preservation



During the **Negative Preservation** phase (which automatically follows each **Freezing** cycle) the cell temperature is kept at -18°C.

Pressing the **STOP** key ends the cycle.

When a cycle is not performed correctly due to a power failure or other reasons, the equipment restarts and returns to the main menu.

## Saving of the completed Positive Chilling cycle

Cycles that have finished and passed on to the preservation phase as expected can be saved.

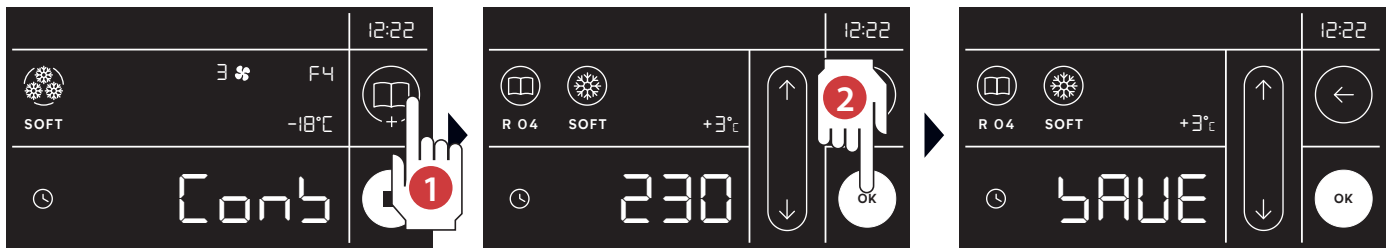

**1** Save the finished cycle by tapping the **add recipe**  key.

**2** The parameters set for the cycle that has just ended will appear on the screen. Tap the OK key to save the cycle, or cancel with the key .

**3** Tap the position at which to save the recipe: confirm the selected position with **OK** or cancel with .

The cycles of my recipes saved from a CYCLE PERFORMED must only be used with the same type of food and of the same size as the cycle performed.



## NEEDLE HEATING

The function is useful for facilitating extraction of the needle from the product after a freezing cycle: it can only be started if its temperature is below -5°C.



**1** At the end of the freezing cycle with the needle probe, the preservation cycle starts and the **Needle heating** key appears.

**2** Select **Needle heating**, the cycle starts.

**3** The heating phase ends automatically after reaching the appropriate temperature for extraction from the product, tap  to exit.

## AIR DEFROST WITH DOOR OPEN



During the entire function, the chiller door must remain open.

**1** Select **Defrost** in the bottom left of the main screen

**2** Select **Start**, the cycle starts.

Defrosting can only start if the evaporator temperature is below 3°C  
The defrost ends:  
- when the defrosting end temperature is reached.  
- by pressing **STOP**

## COOLING

Before starting a **Chilling +3°C** or **Freezing -18°C cycle**, it is preferable to pre-cool the cell and then introduce the food.

To start the function, follow the points **1** and **2** in the figure below: a cycle is immediately activated that brings the chamber temperature to -25°C (once the cycle has started, the display shows the descending chamber temperature).

Once this temperature is reached, a buzzer sounds for 3 seconds every 60 seconds to indicate that the appliance is ready for introduction of the food to be chilled and to perform a **Positive Chilling +3°C** or **Freezing -18°C cycle**.

To end the pre-cooling early, tap the **STOP** key.

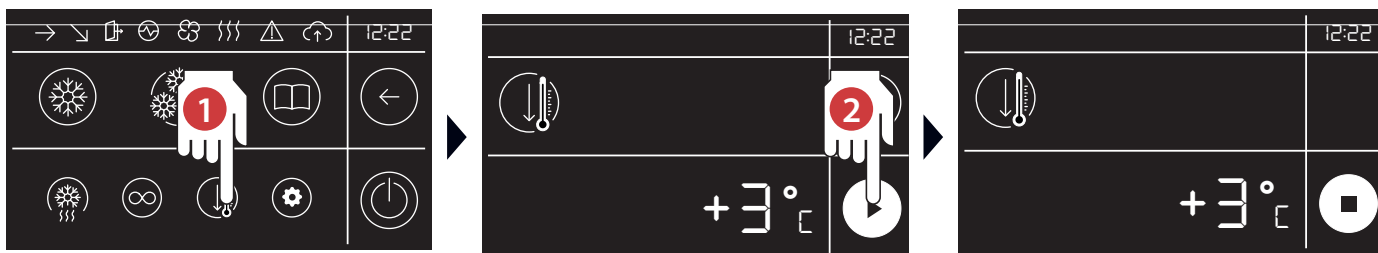

## CONTINUOUS CYCLE

This function is used to quickly set the temperature and air speed of a **continuous cycle** that only ends when the **STOP** key is pressed.

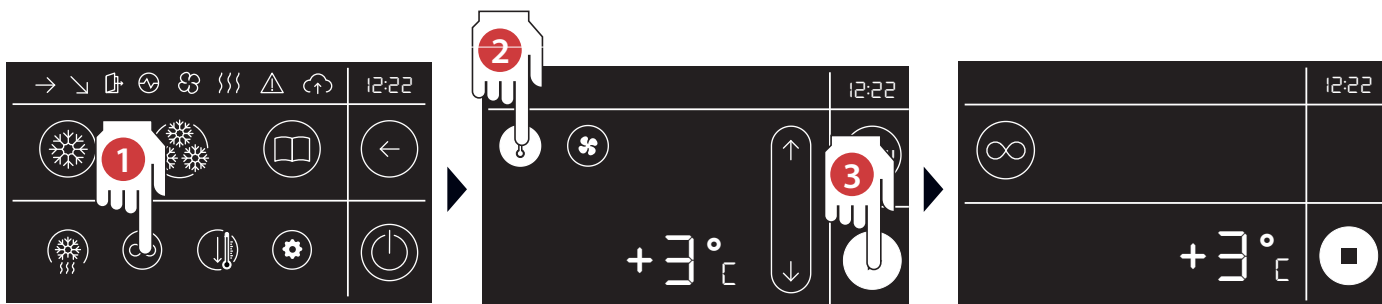

**1** Select **Continuous cycle at the bottom** of the main screen

**2 3** Set the temperature in the chamber, then press the **START**-key: now the chiller will work continuously with the parameters set until the **STOP** key is pressed.

# MAINTENANCE



BEFORE CARRYING OUT ANY MAINTENANCE INTERVENTION, IT IS NECESSARY TO DISCONNECT THE ELECTRICAL SOURCE OF THE EQUIPMENT AND WEAR ADEQUATE PERSONAL PROTECTIVE DEVICES (EX. GLOVES, ETC...).



THE USER MUST CARRY OUT ONLY ROUTINE MAINTENANCE OPERATIONS (UNDERSTOOD AS CLEANING). IN CASE OF EXTRAORDINARY MAINTENANCE, ENTER IN CONTACT WITH AN ASSISTANCE CENTRE AND REQUEST THE INTERVENTION OF AN AUTHORISED TECHNICIAN.



THE WARRANTY WILL BE VOIDED IN CASE OF DAMAGES BY THE LACK OF OR INCORRECT MAINTENANCE (EX. USE OF UNSUITABLE DETERGENTS).

To clean any component or accessory DO NOT use:

- abrasive or powder detergents;
- aggressive or corrosive detergents (ex. hydrochloric/muriatic or sulphuric acid, caustic soda, or with pH >10). Attention! Do not use these substances, even to clean the pavement under the equipment;
- abrasive or sharp utensils (ex. abrasive sponges, scrapers, steel brushes, etc...);
- vapour or pressurised water jets.

On the first use wash the pans and the chamber with a cloth damped with hot water and soap and end with rinsing and drying. To eliminate work residues, make the equipment work empty for around 30 minutes.



## Cleaning of the equipment chamber

Clean the equipment chamber daily to ensure optimum hygiene levels and machine performance.

For this cleaning, use a cloth damp with water and soap, ending with rinsing and drying.

## Touch screen

Use a cloth slightly damp with a product specific for crystals, following the instructions of the detergent manufacturer.

Do not spray too much product to prevent infiltrations that can damage the screen.

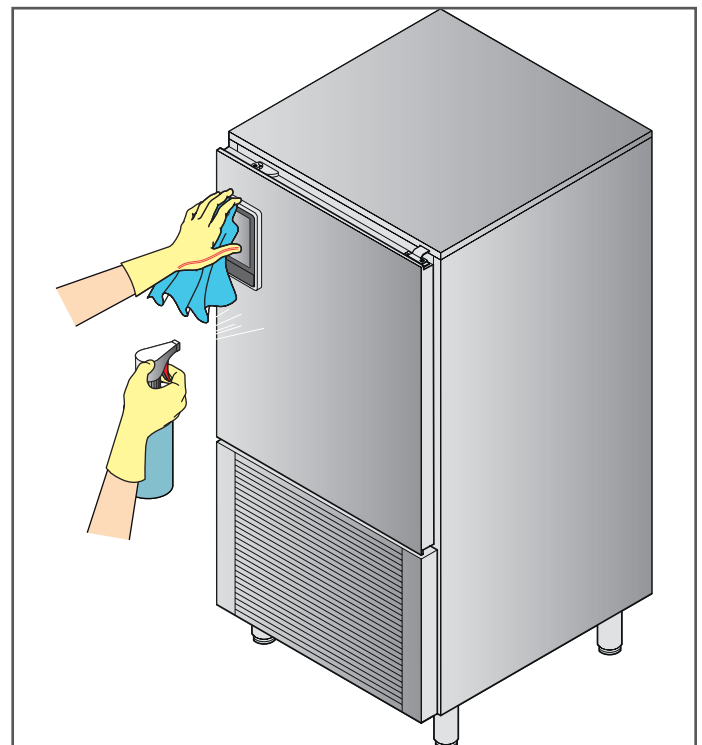

## Cleaning of the grilles

Keep the grilles free of obstructions and dust by cleaning them frequently with a regular vacuum cleaner or a brush.

It is recommended to remove the front panel once a week following the instructions in the figure and to clean the filter with hot water and soap. Should a replacement be necessary, enter in contact with the builder to order spare parts.

## Long shutdowns

During inactivity periods, disconnect the electrical and hydraulic sources. Protect the equipment's external steel parts wiping them with a smooth cloth slightly dampened with Vaseline oil.

Leave the door ajar with the door stop to guarantee a correct air exchange.

For reactivation, before using:

- carry out a careful cleaning of the equipment and accessories;
- reconnect the equipment to the electrical and hydraulic sources;
- carry out an equipment inspection before reusing it;
- restart the equipment at low temperature for at least 60 minutes with no food inside.

 **To be sure that the equipment is maintained in perfect use and safety conditions, we recommend the execution of a maintenance and inspection service by an authorised assistance centre, at least once a year.**

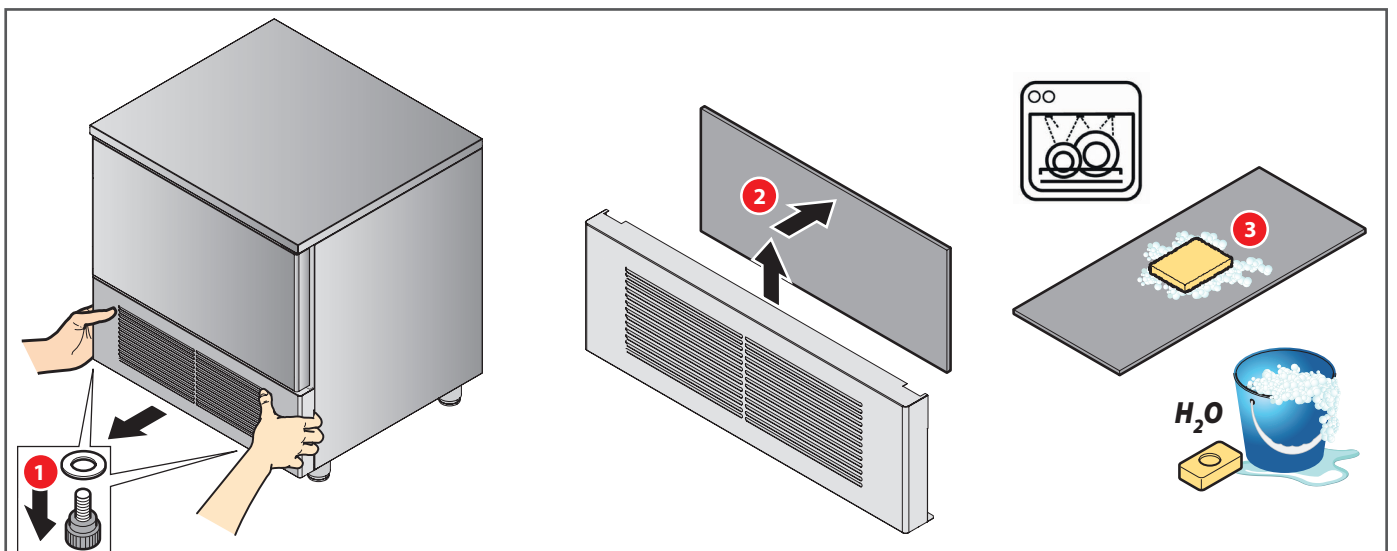
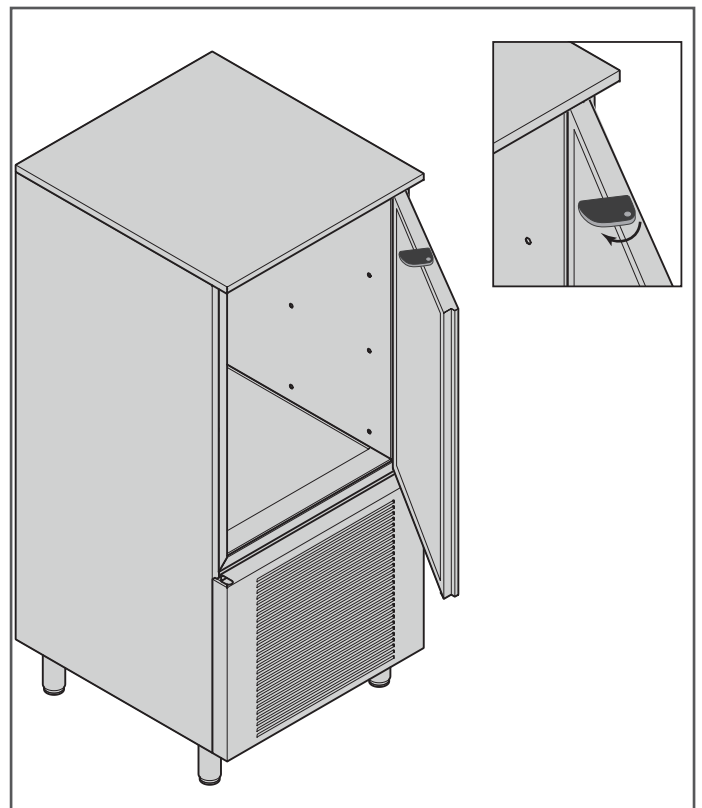
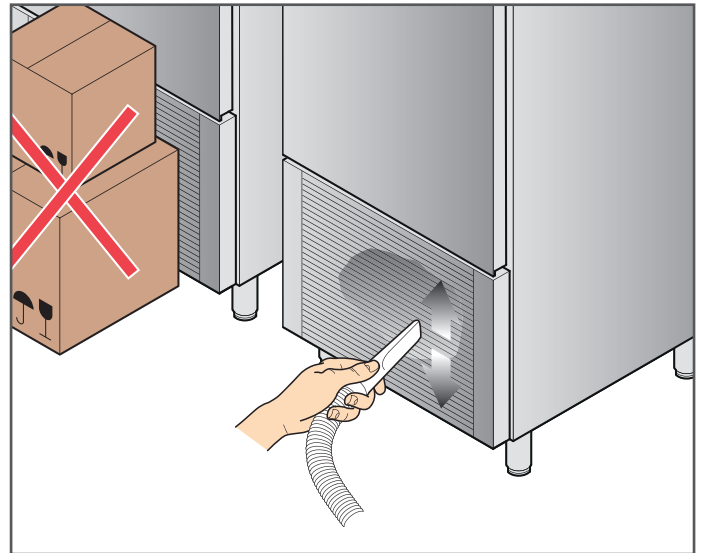

If the equipment does not work or if functional or structural changes are noticed:

- disconnect it from the electrical and water sources;
  - consult the table below to check the proposed solutions;
- Should the solution not be present in the table, enter in contact with the assistance centre authorised by the manufacturer, communicating:
- the type of fault;
  - the code and the serial number of the equipment that can be found on its characteristics plate.

For repairs, use only original spare parts: the manufacturer declines any responsibility and does not grant the right of warranty when non-original spare parts are used.

 To be sure that the equipment is maintained in perfect use and safety conditions, we recommend the execution of a maintenance and inspection service by an authorised assistance centre, at least once a year.

**Manufacturer data:**

F.R.C.  
Via Treviso, 4 33083 - Taiedo di Chions (PN) - Italy  
Tel. +39.0434.635411 - Fax. +39.0434.635414

- |    |                               |    |                                      |
|----|-------------------------------|----|--------------------------------------|
| 1  | Manufacturer                  | 11 | Lamp power                           |
| 2  | Serial number                 | 12 | Minimum and maximum pressure         |
| 3  | Code                          | 13 | Refrigeration gas, type and quantity |
| 4  | Model                         | 15 | Insulation expanding gas             |
| 5  | Voltage                       | 16 | Manufacture year                     |
| 6  | Running absorbed current      | 17 | Climatic class (#)                   |
| 8  | Defrost heating element power |    |                                      |
| 9  | Defrost heating element power |    |                                      |
| 10 | Other elements nominal power  |    |                                      |

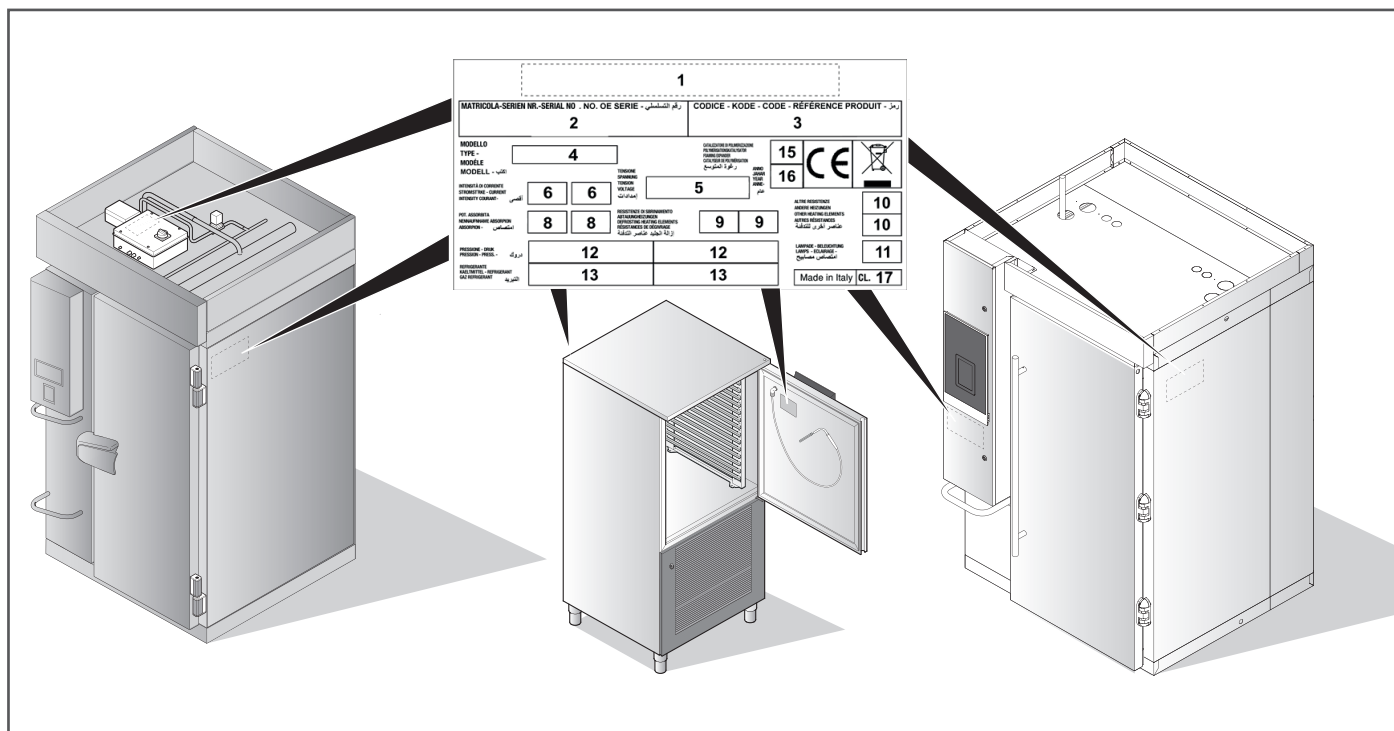

Type of problem	Before seeking contact with an assistance centre, check that...
The equipment is completely shut off.	<ul style="list-style-type: none"> <li>- ...that electrical voltage is present on the equipment and that the plug was plugged into the socket.</li> </ul>
The equipment does not chill sufficiently	<ul style="list-style-type: none"> <li>- ...there is no effect of an external heat source;</li> <li>- ...the doors close perfectly;</li> <li>- ...the condenser filter is not clogged;</li> <li>- ...the front ventilation grilles are not obstructed by objects or dust;</li> <li>- ...the food is evenly distributed inside the cell and does not obstruct the ventilation inside the cell;</li> <li>- ...the equipment is not overloaded with food (comply with the equipment load indications affixed on it).</li> </ul>
The equipment is very noisy	<ul style="list-style-type: none"> <li>- ...there is no contact between the equipment any other object or machine;</li> <li>- ...the equipment is perfectly levelled;</li> <li>- ...the visible bolts are well tightened.</li> </ul>



Do not try to repair the equipment by yourself, this may cause damage, even serious, to persons, animals and objects, and cause the voiding of the Warranty.  
Always look for an assistance centre authorised by the manufacturer and order ORIGINAL spare parts.

# DISPOSAL AND END OF SERVICE LIFE

The defrosting operations of the electrical and hydraulic circuits must be carried out exclusively by qualified technicians. If present, remove them and dispose them off in a correct manner:

- refrigeration gas;
- anti-freeze solutions present in the hydraulic circuits, avoiding spillage or losses in the environment.

According to art.13 of Legislative Decree no. 49 of 2014 "Application of Directive RAEE 2012/19/EU on residues of electrical and electronic equipment"



The mark with stripes on the stripped dumpster specifies that the product was placed on the market after August 13, 2015, and that, at the end of its service life, must not be mixed with other residues, but disposed off separately.

The whole equipment was built with recyclable metallic materials (stainless steel, iron, aluminium, zinc-coated plates, copper, etc.) in percentage above 90% of the weight.

Render the equipment unusable when disposing off by removing the power source cable and any other device that closes the compartments or cavities (where present).

Care must be taken in the management of this product at the end of its service life, to mitigate negative impacts on the environment and improve the effectiveness of the use of resources, applying the principles of "who pollutes pays", prevention, preparation for re-utilisation, recycling and recovery.

We remind that the uncontrolled or incorrect disposal of the product is liable to the application of the sanctions foreseen in the present legal standards.

## Information about disposal in Italy

In Italy, RAEE equipment must be delivered to:

- Collection Centres (also known as ecological islands or ecological platforms)
- the dealers in which new equipment can be purchased, which are requested to collect it free of charge (collection "one for one");

## Information about disposal in the European Union nations

The community Directive on RAEE equipment was accepted in different ways by each nation, therefore, if this equipment must be disposed off, we suggest a contact with the local authorities or the Dealers about the correct disposal method.



While waiting for demolition or disposal, the equipment can be temporarily stored, also in open air, because the unit has its electrical, refrigeration and hydraulic circuits integrated and closed. However, make sure that the doors cannot be closed to avoid entrapment.

The laws in force in the user's country concerning environment protection must also be observed.

# WARRANTY

The manufacturer's obligation regarding the warranty that covers the equipment and other parts produced by it is valid for a period of 1 year as of the invoice date, and consists of the supply free of charge of parts that must be replaced that, at its own discretion, are considered defective.

It will be the manufacturer's duty to solve eventual faults and defects, provided the equipment is correctly installed and operated in accordance with the instructions contained in the manual. Any damage arising from limescale build-up, over voltage or tampering by unauthorised or unqualified personnel will void the warranty.

Consumption components such as glass, aesthetic parts, seals, lamps and parts that subject to wear after utilisation, are excluded from the warranty.

During the warranty period, the expenses concerning providing of services, travels or transfers, transport of parts and eventual replacement equipment are borne by the purchaser.

The materials replaced under warranty will remain of our property and must be returned at the purchaser's care and expense.

**F.R.C.**

Via Treviso, 4 33083 - Taiedo di Chions (PN) - Italia  
Tel. +39.0434.635411 - Fax. +39.0434.635414

