

# Owner's instructions

## Alexander 5T - 10T - 15T

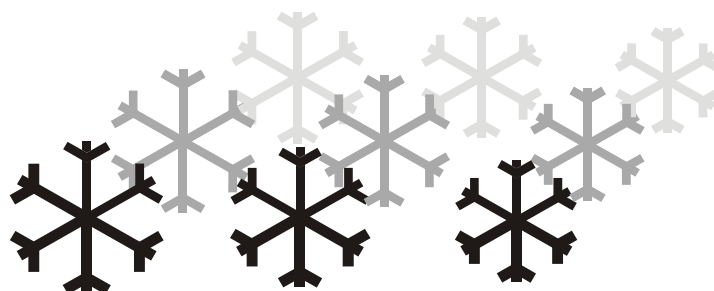

**Made in Italy**





## **STUDIO 54 SRL**

**Via Gian Lorenzo Bernini 147, Z.I. Paviola 3  
35010 S. Giorgio in Bosco (Pd) Italy  
TEL. 049 9450466 FAX. 049 9451044**

**http: [www.studio-54.it](http://www.studio-54.it)**

**E-Mail: [info@studio-54.it](mailto:info@studio-54.it)**

## **1. General Information**

We recommend you to read carefully the owner's instructions, remembering that it is an integral part of this equipment, and it must be kept with care.

In case of loss or damaging of the present manual, don't hesitate to request another copy of it, specifying the model and the date of purchase of the product.

The blast chiller/freezer has been designed and built exclusively to blast chilling/freezing of temperature for food.

THE PRODUCING COMPANY DECLINES ANY RESPONSIBILITY FOR DAMAGES RESULTING FROM

- *ILLEGITIMATE USE*
- *USING OF NOT ORIGINAL SPARE PARTS*
- *NON-AUTHORIZED MODIFICATIONS ON THE PRODUCT*
- *FAILURE TO COMPLY WITH THIS MANUAL INSTRUCTIONS*

### **ELEMENTARY SAFETY MEASURES**

- Unplug before making any kind of intervention on the electrical parts: the contact can cause the death.
- Don't use the appliance with damp or wet hands or feet.
- Unplug before cleaning the appliance.
- Don't insert any screwdriver, kitchen utensil, etc. among the moving components or the protections.

## **2. Preliminary checks**

At the receiving of the product, please verify immediately the packaging integrity checking if there is any transport damaging.

Open the packaging and make sure that there are all the accessories.

If there have been transport damages, inform immediately the driver; within three days such reservations must be confirmed by recorded delivery letter addressed to the forwarder sending a copy of it directly to the producing company or its reseller.

Every claim must be notified within 8 days from the receiving of the goods.

### **3. Warranty terms**

The product is covered by a 12 months warranty starting from the date of the purchase, except for the electrical components. The spare parts will be eventually supplied under warranty ex works San Giorgio in Bosco (PD).

Before the delivery of spare parts under warranty, there must be the returning of the damaged goods.

The warranty certificate must be filled and sent to the producer within 8 days from the installation.

### **4. Installation**

The main characteristics, as dimensions, absorption, etc., are specified on the European Community silver label.

The appliance must use an electric socket equipped with an automatic cut-out, respecting the safety regulations. Make also sure that voltage and power line are suitable to the motor absorption.

#### **4.1 POSITIONING**

The installer must verify the presence of fire prevention regulations, and place the appliance in full obedience of the industrial injuries legislation and the current regulations.

The appliance works with an air condenser, so it is necessary to pay attention to the placing of it, keeping free the side of the incoming of the cooling air.

Besides, it is also necessary to keep it at least at 20 cm from wall or other appliances nearby the air exit, so as to obtain the best performances.

To refrain from placing the appliance in closed or poorly aired spaces, from exposing it directly to sun-beams, and from the heat sources.

#### **4.2 AMBIENT**

Generally, the refrigerators with air condensing units work with a maximum ambient temperature of 32°C. The declared performances are not guaranteed where there are higher temperatures.

The producing company guarantees an IP43 degree of protection (in accordance with CEI 70-1 EN 60529 and IEC529 laws). The installer will estimate if different ambient conditions require other kind of protection degrees.

## NOTE

Correct installation:

- Verify the electrical connections
- Verify the absorption at working appliance
- Switch on the fridge and let it to reach the desired temperature before putting inside the food

If the appliance has been transported in a non-appropriate way (i.g. non-vertical position or laying on the back), wait at least 4 hour before switching it on. The end user must be informed on the right use of the appliance.

### 4.3 CORRECT DISPOSAL

**Subject:** Legislative Decree n. 151 dtd 25/07/2005 (ROHS – RAEE)

**Correct disposal of this product (waste electrical and electronic equipment)**  
(Applicable in the European Union and other European countries with separate collection systems)



**IT0802000000717**

This marking shown on the product or its literature, indicates that it should not be disposed with other household wastes at the end of its working life.

To prevent possible harm to the environment or human health from uncontrolled waste disposal, please separate this from other types of wastes and recycle it responsibly to promote the sustainable reuse of material resources.

Household users should contact either the retailer where they purchased this product, or their local government office, for details of where and how they can take this item for details of where and how they can take this item for environmentally safe recycling.

Business users should contact their supplier and check the terms and conditions of the purchase contract. This product should not be mixed with other commercial wastes for disposal.

Some economic sanctions to the defaulting user are provided for wrong wasting of the products with RAEE mark.

## 5. OWNER'S INTERFACE











THE WORKING AND THE SETTING OF THE DIGITAL CONTROL DEVICE ARE EXPLAINED IN THE ENCLOSED INSTRUCTION MANUAL FOR THE DIGITAL CONTROL DEVICE EVCO **EVC80S10P7XXX01**

## 6. KEYS

SYMBOL	NAME
	START Key
	TIME BLAST CHILLING Key
	TEMPERATURE BLAST CHILLING Key
	TIME BLAST FREEZING Key
	TEMPERATURE BLAST FREEZING Key
	DEFROSTING Key
	INCREASE Key
	DECREASE Key

## 6.1 Icons

SYMBOL	NAME
	<b>BLAST CHILLING icon</b> It flashes during the blast chilling cycle, it is switched on during the successive preservation.
	<b>SHOCK FREEZING icon</b> It flashes during the shock freezing cycle, it is switched on during the successive preservation.
	<b>PRESERVATION icon</b> It is switched on or it flashes during a preservation cycle.
	<b>TEMPERATURE icon</b> It is switched on during a temperature cycle.
	<b>TIME icon</b> It is switched on during a time cycle.
	<b>OFF icon</b> It is switched on when the digital control device is in off, it is off with all the other functions.
	<b>FAHRENHEIT icon</b> It is switched on in red or green, depending by the colour of the display, if it is displayed a temperature, and if the unit of measurement is the Fahrenheit degree.
	<b>CELSIUS icon</b> It is switched on in red or green, depending by the colour of the display, if it is displayed a temperature, and if the unit of measurement is the Celsius degree.

## 7. INSTRUCTION FOR THE STARTING OF THE BLAST CHILLING AND SHOCK FREEZING CYCLES

Here follow the setting instructions for the starting of the most common functions of the appliance.

**N.B.** FOR A BETTER WORKING OF THE APPLIANCE, REMEMBER TO MAKE AN AUTOMATIC DEFROSTING AFTER 2/3 CONSECUTIVE BLAST CHILLING/FREEZING CYCLES.

SUCH OPERATION CAN BE MADE KEEPING THE DOOR OPEN AND



PRESSING THE DEFROSTING KEY  . THAT SUCCESSION OF CONTROLS MAKES THE APPLIANCE GO INTO THE AUTOMATIC DEFROSTING FUNCTION.

**ATTENTION:** We recommend you to insert the food probe 2 – 3 cm max inside the product.

## 7.1 SOFT TEMPERATURE BLAST CHILLING

Procedure to use the SOFT temperature blast chilling function:

1. Insert the probe in the food
2. Press the TEMPERATURE BLAST CHILLING key  until when it appears the word SOFT. After 3 seconds the displays shows the set point of temperature of the cell during the blast chilling function (-5°C) in red light.

Such value can be changed pressing the increase and decrease   keys, and must be confirmed with the TEMPERATURE BLAST CHILLING key .

3. Start the working cycle pressing the START key 
4. The blast chilling cycle ends when the probe temperature goes to +3°C.
5. Now it automatically starts the preservation phase.



During the temperature blast-chilling phase it is always possible to visualize the probe temperature pressing the TEMPERATURE BLAST CHILLING key .

In that way, on the display will appear for 5 seconds the probe temperature in green light.

Moreover, it is always possible to visualize the passed time from the beginning of the cycle pressing the TIME BLAST CHILLING key .

In that way, on the display it will appear for 5 seconds the passed time from the beginning of the cycle in green light.

When it is time to remove the food from the blast chiller/freezer press the START key .



Pressing for 3 seconds one of the keys     the digital control device goes in standby and the machine is ready for a new cycle.



## 7.2 HARD TEMPERATURE BLAST CHILLING

Procedure to use the HARD temperature blast chilling function:

1. Insert the probe in the food
2. Press the TEMPERATURE BLAST CHILLING key  until when it appears the word HARD. After 3 seconds the displays shows the set point of temperature of the cell during the blast chilling function (-5°C) in red light.

Such value can be changed pressing the increase and decrease   keys, and must be confirmed with the TEMPERATURE BLAST CHILLING key .

3. Start the working cycle pressing the START key 
4. The blast chilling cycle ends when the probe temperature goes to +3°C.
5. Now it automatically starts the preservation phase.

During the temperature blast-chilling phase it is always possible to visualize the probe temperature pressing the TEMPERATURE BLAST CHILLING key .

In that way, on the display will appear for 5 seconds the probe temperature in green light.

Moreover, it is always possible to visualize the passed time from the beginning of the cycle pressing the TIME BLAST CHILLING key .

In that way, on the display it will appear for 5 seconds the passed time from the beginning of the cycle in green light.

When it is time to remove the food from the blast chiller/freezer press the START key .

Pressing for 3 seconds one of the keys     the digital control

device goes in standby and the machine is ready for a new cycle.

### 7.3 SOFT TIME BLAST CHILLING

Procedure to use the SOFT time blast chilling function:

1. Insert the probe in the food
2. Press the TIME BLAST CHILLING key  until when it appears the word SOFT. After 3 seconds the displays shows the set point of temperature of the cell during the blast chilling function (-5°C) in red light.

Such value can be changed pressing the increase and decrease



keys, and must be confirmed with the TIME BLAST CHILLING key

3. Set the desired working time with the increase and decrease



keys and confirm with the TIME BLAST CHILLING key



4. Start the working cycle pressing the START key



5. The blast chilling cycle ends when the set time as during of chilling phase has passed.

6. Now it automatically starts the preservation phase.

During the time blast-chilling phase it is always possible to visualize the probe temperature pressing the TEMPERATURE BLAST CHILLING key



In that way, on the display will appear for 5 seconds the probe temperature in green light.

Moreover, it is always possible to visualize the passed time from the beginning of the cycle pressing the TIME BLAST CHILLING key



In that way, on the display it will appear for 5 seconds the passed time from the beginning of the cycle in green light.

When it is time to remove the food from the blast chiller/freezer press the START key



Pressing for 3 seconds one of the keys  the digital control device goes in standby and the machine is ready for a new cycle.

## **7.4 HARD TIME BLAST CHILLING**

Procedure to use the HARD time blast chilling function:

1. Insert the probe in the food
2. Press the TIME BLAST CHILLING key  until when it appears the word SOFT. After 3 seconds the displays shows the set point of temperature of the cell during the blast chilling function (-5°C) in red light.

Such value can be changed pressing the increase and decrease

keys, and must be confirmed with the TIME BLAST CHILLING key



3. Set the desired working time with the increase and decrease



keys and confirm with the TIME BLAST CHILLING key



4. Start the working cycle pressing the START key 
5. The blast chilling cycle ends when the set time as during of chilling phase has passed.
6. Now it automatically starts the preservation phase.

During the time blast-chilling phase it is always possible to visualize the probe temperature pressing the TEMPERATURE BLAST CHILLING key







In that way, on the display will appear for 5 seconds the probe temperature in green light.

Moreover, it is always possible to visualize the passed time from the beginning of the cycle pressing the TIME BLAST CHILLING key





In that way, on the display it will appear for 5 seconds the passed time from the beginning of the cycle in green light.

When it is time to remove the food from the blast chiller/freezer press the START key .

Pressing for 3 seconds one of the keys     the digital control device goes in standby and the machine is ready for a new cycle.

## **7.5 TEMPERATURE SHOCK FREEZING**

Procedure to use the temperature shock freezing function:

1. Insert the probe in the food
2. Press the TEMPERATURE SHOCK FREEZING key 
3. Start the working cycle pressing the START key 
4. The blast chilling cycle ends when the probe temperature goes to -18°C.
5. It automatically starts the preservation phase.

During the temperature blast freezing phase it is always possible to visualize the probe temperature pressing the TEMPERATURE SHOCK FREEZING key .





In that way, the probe temperature will appear in green light for 5 seconds on the display.

Moreover, it is always possible to visualize the passed time from the beginning of

the cycle pressing the TIME SHOCK FREEZING key .





In that way, on the display will appear in green lighting for 5 seconds the passed time from the beginning of the cycle.

When it is time to remove the food from the blast chiller/freezer press the START key .

Pressing for 3 seconds one of the keys     the digital control device goes in standby and the machine is ready for a new cycle.

## **7.6 TIME SHOCK FREEZING**

Procedure to use the time shock freezing function:

1. Insert the probe in the food
2. Press the TIME SHOCK FREEZING key 
3. Set the desired working time with the increase and decrease   keys and confirm with the TIME SHOCK FREEZING key .
4. Start the working cycle pressing the START key 
5. The shock freezing cycle ends when the set time as during of chilling phase has passed.
6. Now it automatically starts the preservation phase.

During the time blast-chilling phase it is always possible to visualize the probe temperature pressing the TEMPERATURE SHOCK FREEZING key 

In that way, on the display will appear for 5 seconds the probe temperature in green light. Moreover, it is always possible to visualize the passed time from the beginning of

the cycle pressing the TIME SHOCK FREEZING key . In that way, on the display it will appear for 5 seconds the passed time from the beginning of the cycle in green light.

When it is time to remove the food from the blast chiller/freezer press the START key .

Pressing for 3 seconds one of the keys     the digital control device goes in standby and the machine is ready for a new cycle.

## **8. USE ADVICES**

**N.B. ATTENTION: THE BLAST CHILLER/FREEZER MUST NOT BE USED AS A NORMAL REFRIGERATING APPLIANCE.**

**N.B. DO NOT INSERT FOOD WITH HIGHER TEMPERATURE THAN 70°C: THE ELECTRICAL CONTROL DEVICE WILL INDICATE AN ERROR.**

It is advisable, to have the best performances from the appliance, to chill the chamber making a whole working cycle (chilling or freezing) at least until the achieving of the preservation temperature, before putting inside the product.

Moreover, to avoid damages to the appliance:

- Do not leave the hot product inside the appliance without starting a cycle.
- Start immediately the suitable working cycle only just after having put inside the product to treat.
- Avoid covering the inside holders (also with isolating films): the best performances and times are with the maximum quantity of exposed surface.
- Do not overload the appliance:
  - 5T chilling 16 kg – freezing 12 kg;
  - 10T chilling 38 kg – freezing 25 kg;
  - 15T chilling 60 kg – freezing 45 kg;
- In order to allow a better air circulation, leave a sufficient space between the inserted holders.
- Place the inserted holder on the supplied grates and not directly on the bottom part.

**N.B. REMEMBER PERIODICALLY TO CHECK THE DEFROSTING WATER PAN PUT ON THE BOTTOM OF THE APPLIANCE, AND TO EMPTY IT.**

### **8.1 FEATURES OF THE PRODUCT TO TREAT**

Considering that the referring timings of the cycles start from +70°C (chilling cycle from +70°C to +3°C; freezing cycle from +70°C to -18°C :

- Do not leave the food for long time in ambient temperature: the higher is the humidity lost from the product, the lower will be the preserved softness.
- Insert the product at a higher temperature than +70°C.

**N.B. PULL OUT THE PROBE FROM THE TREATED FOOD TAKING IT UP BY THE RIGID PART OF IT AND NOT PULLING IT BY THE CABLE. THE WRONG ACTION CAN CAUSE ITS BREAKING, AND ITS SUBSTITUTION WILL NOT BE DONE UNDER WARRANTY.**

## **9. ROUTINE MAINTENANCE**

In order to make an adequate maintenance of the appliance, the user, the maintenance man or the non-specialized staff must firstly keep in mind the elementary safety rules quoted on paragraph n. 1 GENERAL INFORMATION. Then, it is also compulsory to not remove the safety devices and the protections during the routine maintenance.

OTHERWISE, THE PRODUCING COMPANY DECLINES ANY RESPONSIBILITY FOR DAMAGES OR ACCIDENTS RESULTING FROM THE FAILURE TO COMPLY WITH THE ABOVE-STATED OBLIGATION.

Considering the previous rules, the cleaning of the cooled storage must be done daily, in order to guarantee the best quality and the perfect sanitariness of the treated products. Use water and non-abrasive cleansing agents. Wash and rinse using a cloth or a sponge.

### **N.B. NO SHARP OR ABRASIVE INSTRUMENTS, NO SOLVENTS OR DILUENTS**

For a better air circulation, keep clean also the condensing unit (part 10) removing from its wings dust etc. To reach the condensing unit, you must pull out the plug from the electrical socket, and unscrew the front panel (part 14) paying attention on not putting in excessive traction the electrical connections. Use a vacuum cleaner in order of not having a dispersion of dust. Do not scrape with sharp or abrasive instruments.

At the end, reassemble the front panel closing the fixing screws.

The defrosting water goes inside a tank in the bottom of the blast chiller/freezer. In case of extraordinary maintenance to the refrigerating system, it is possible to remove the back panel, and also the lateral panel if necessary. Such operations can be made exclusively by refrigerator or authorised technicians, and only after having pulled out the plug from the electrical socket.

## 10. ALARMS LIST

Here following we explain you the most frequent alarms of this appliance. For any further information, we suggest you to read the enclosed owner's instructions of the digital control device **EVC80S10P7XXX01**

CODE	PROBLEM	SOLUTION
Er 1	Failure chamber probe	Check connections an functioning of the chamber probe
Er 2	Failure product probe	Check connections an functioning of the product probe
Er 3	Failure evaporator probe (only if enabled)	Check connections an functioning of the evaporator probe
Er 4	Failure condenser probe (only if enabled)	Check connections an functioning of the condenser probe
AL 1	Open door alarm	Close the door
AL 2	High pressure alarm	Remove the alarm cause, turn off and switch on the appliance
AL 3	High temperature condensing alarm (only if enabled)	Wait the condenser drop in temperature
AL 4	Not inserted pin	Check the pin insertion



# CE PLATE

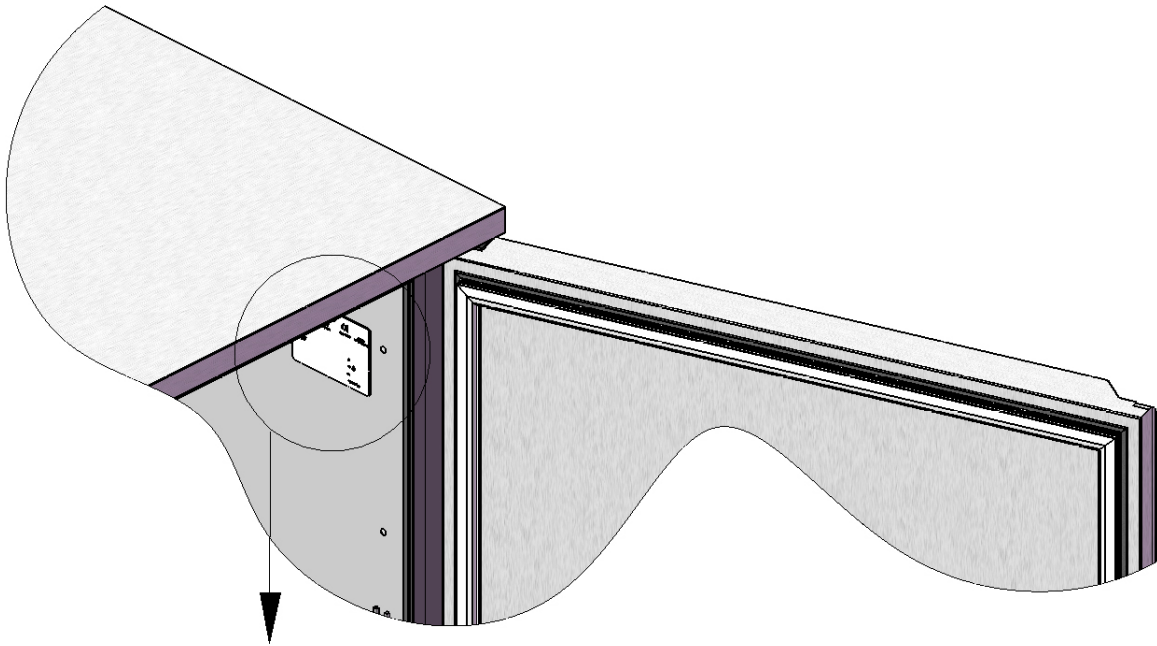

SERIAL NUMBER  
 MANUFACTURING DATE  
 TOTAL ABSORPTION  
 FREQUENCY

<b>STUDIO 54 S.r.l</b>		<b>CE</b>	
Via Gian Lorenzo Bernini 147 35010 S.Giorgio in Bosco (PD) Italy Tel. 049-9450466 Fax 049-9451044		01/01/2000	IT08020000000717
MODEL	MOD. ALEXANDER 10.T	Nr. 00000001	
VOLTAGE	V <b>400/3N</b>	W <b>2140</b>	Hz <b>50</b>
	W  /		A <b>3,08</b>
	W  /		W  /
	Gas (1) R404A	Kg (1) 1,900	Cl. <b>4</b>
	Gas (2) HSC365/227		made in Italy

FOAM MIXING REAGENT  
 CLASS  
 KIND & QUANTITY OF COOLING MEANS INSIDE THE CIRCUIT  
 TOTAL STREAM ABSORPTION

# ALEXANDER 5T

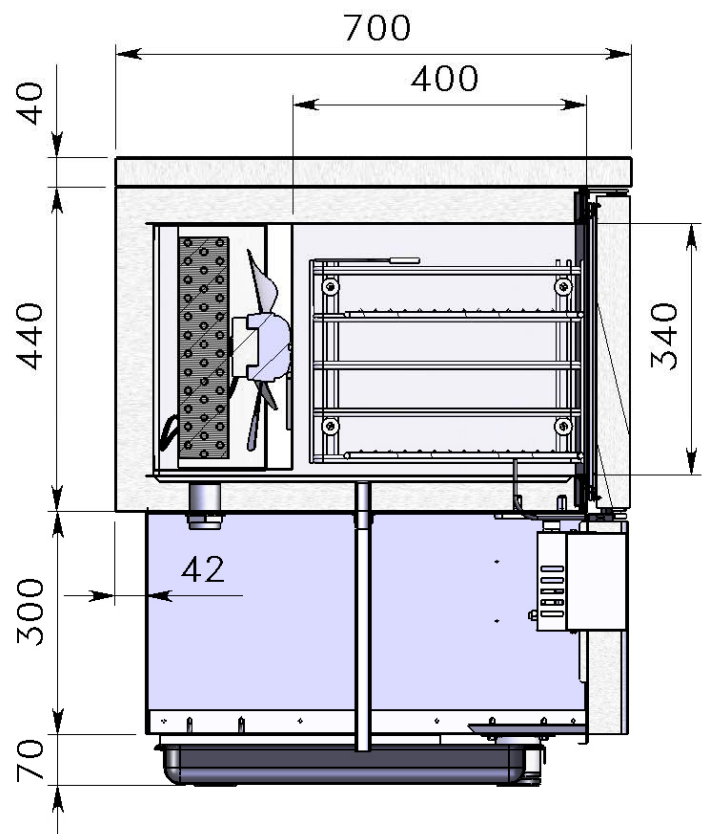
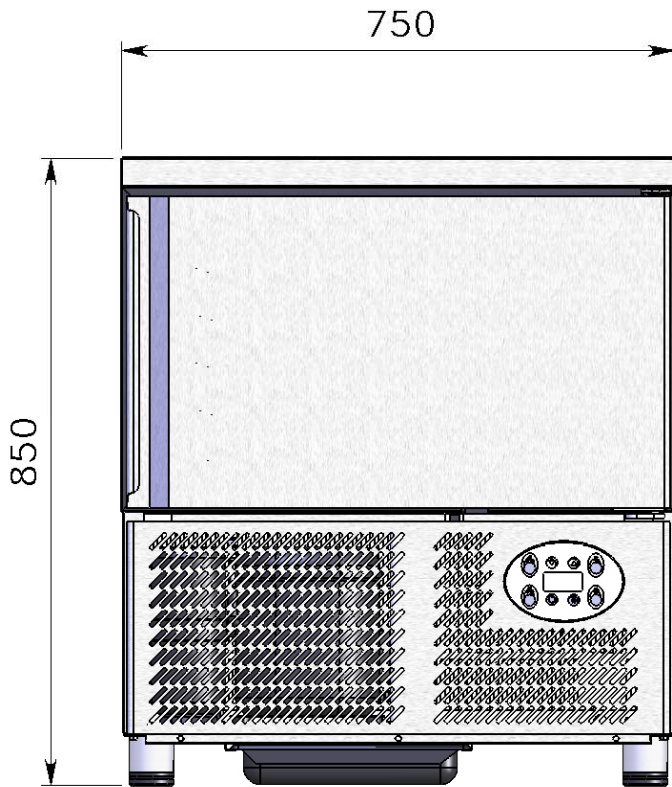

# 11. ALEXANDER 5T EXPLODED VIEW

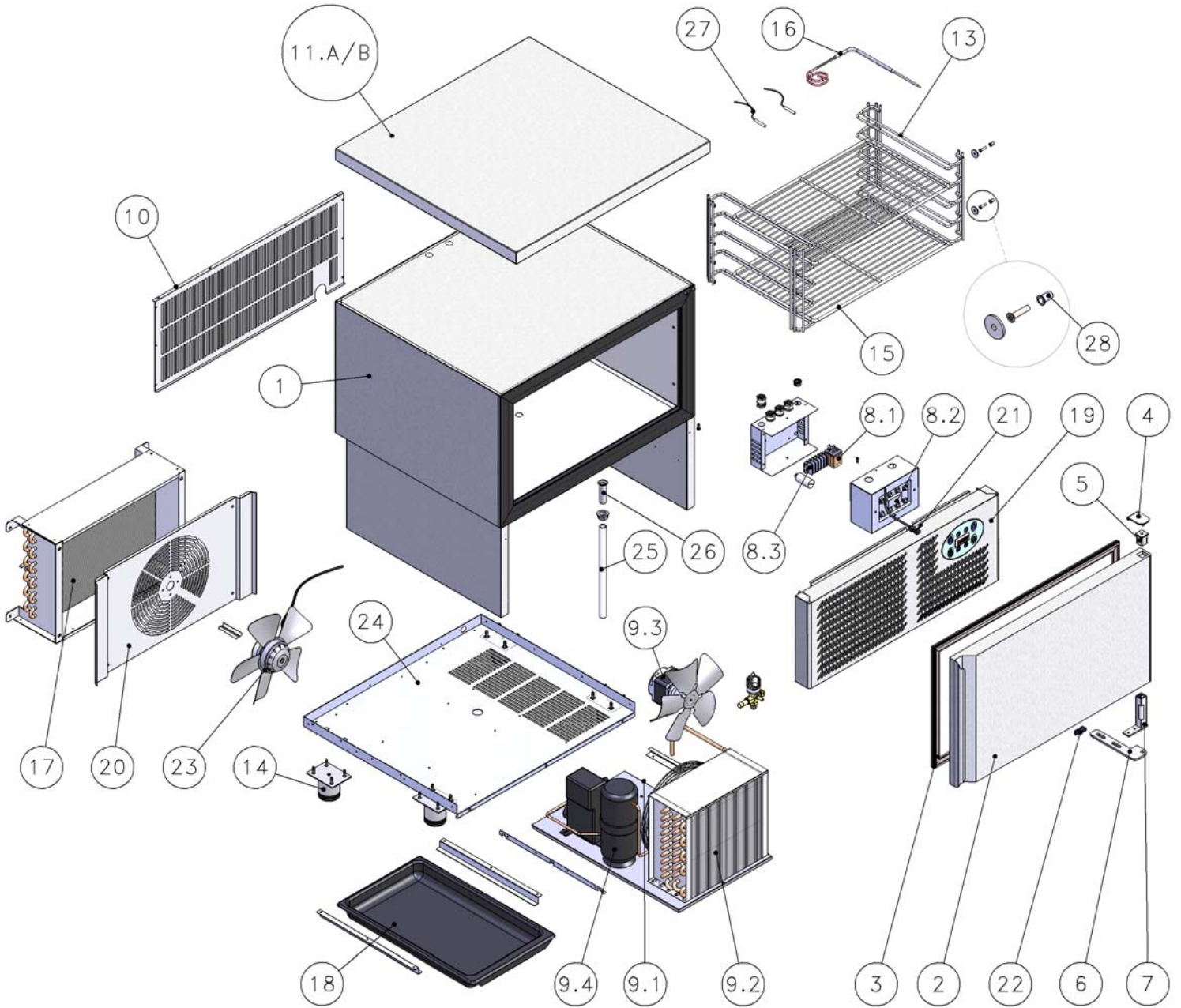

## 12. SPARE PARTS ALEXANDER 5T LIST

Articolo num.	NUMERO PARTE	Descrizione	Quantità
1	63600370	INSULATED BODY	1
2	63600363	INSULATED DOOR	1
3	64691084	MAGNETIC GASKET	1
4	62500260	SUPERIOR DOOR HINGE	1
5	64700132	BEARING IN PVC	1
6	62500130	INFERIOR DOOR HINGE	1
7	64700128	LOWER TWISTING HINGR	1
8.1	64740150	RELAY	1
8.2	64740178	TEMPERATURE CONTROL DEVICE	1
8.3	64740033	TERMINAL BOX 5	1
9.1	64850320	COMPRESSOR T2180GK	1
9.2	64840105	CONDENSER	1
9.3	64840112	CONDENSER FAN MOTOR	1
9.4	64850323	TANK 1,6 Lt.	1
10	62454024	BACK COVER STEEL	1
11.A	63600245	WORKING TOP	1
11.B	63600253	WORKING TOP WITH SPLASHBACK	1
13	64700112	TRAY HOLDER FRAME	2
14	64700066	FEET H=70	4
15	64700091	GRATE 530x325	1
15	64700092	GRATE 600x400	1
16	64740160	PIN PROBE	1
17	64860166	EVAPORATOR	1
18	64740105	DEFROSTING WATER TANK	1
19	62454054	ELECTRICAL SWITCH PANEL	1
20	62454038	SUPPORT STEEL EVAPORATOR FAN	1
21	64740096	DOOR MICRO-SWITCH	1
22	64740098	DOOR MICRO-SWITCH	1
23	64840101	EVAPORATOR FAN	1
24	62454066	BOTTOM	1
25	64700213	DISCHARGE Ø20x75	1
26	64700159	DISCHARGE Ø20	1
27	64740165	PTC PROBE	2
28	64904053	INSERT M4 L=13mm	8

### 13. WIRING DIAGRAM ALEXANDER 5T

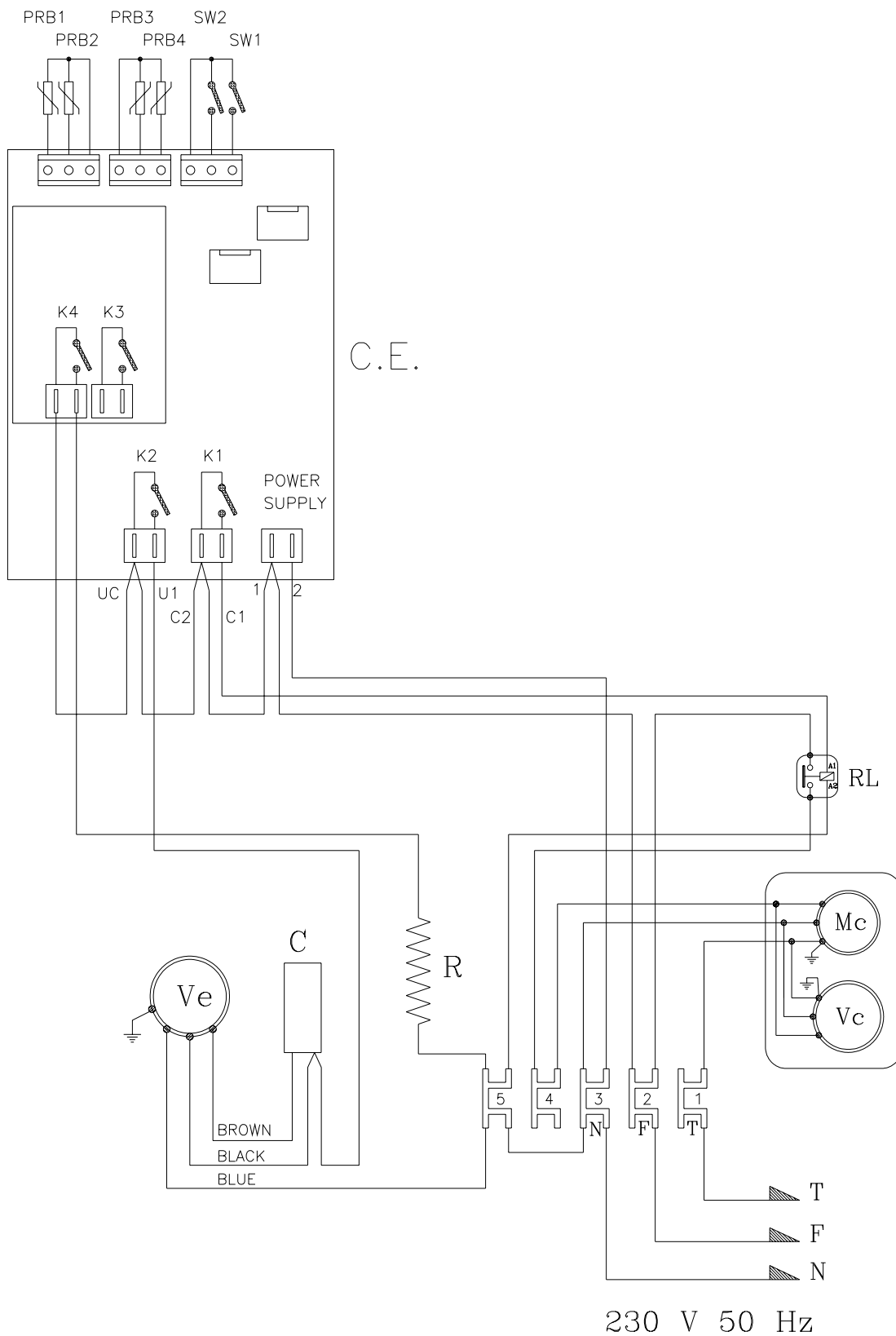

C.E.= EVC80S10P7XXX01

LEGENDA:

RL=RELE' 30A  
MC=COMPRESSORE  
VC=VENTOLA CONDENSATORE  
VE=VENTOLA EVAPORATORE 1  
R=CAVO CALDO CORNICE  
C=CONDENSATORE DI SPUNTO  
K1=RELE' COMPRESSORE  
K2=RELE' VENTILATORE EVAPORATORE  
K3=RELE' SBRINAMENTO  
K4=RELE' RESISTENZA RISCALDANTE  
PRB1=SONDA SPILLONE  
PRB2=SONDA CELLA  
PRB3=SONDA CONDENSATORE  
PRB4=SONDA EVAPORATORE  
SW2=MICRO PORTA

C.E.= EVC80S10P7XXX01

LEGENDA:

RL=RELAY 30A  
MC=COMPRESSOR  
VC=CONDENSER FAN  
VE=EVAPORATOR FAN 1  
RES=FRAME HEATING WIRE  
C=CONDENSER 2MF  
K1=COMPRESSOR RELAY  
K2=EVAPORATOR FAN RELAY  
K3=DEFROSTING RELAY  
K4=HEATING RESISTANCE RELAY  
PRB1=PIN PROBE  
PRB2=COLD ROOM PROBE  
PRB3=CONDENSER PROBE  
PRB4=EVAPORATOR PROBE  
SW2=DOOR MICRO SWITCH

# ALEXANDER 10T

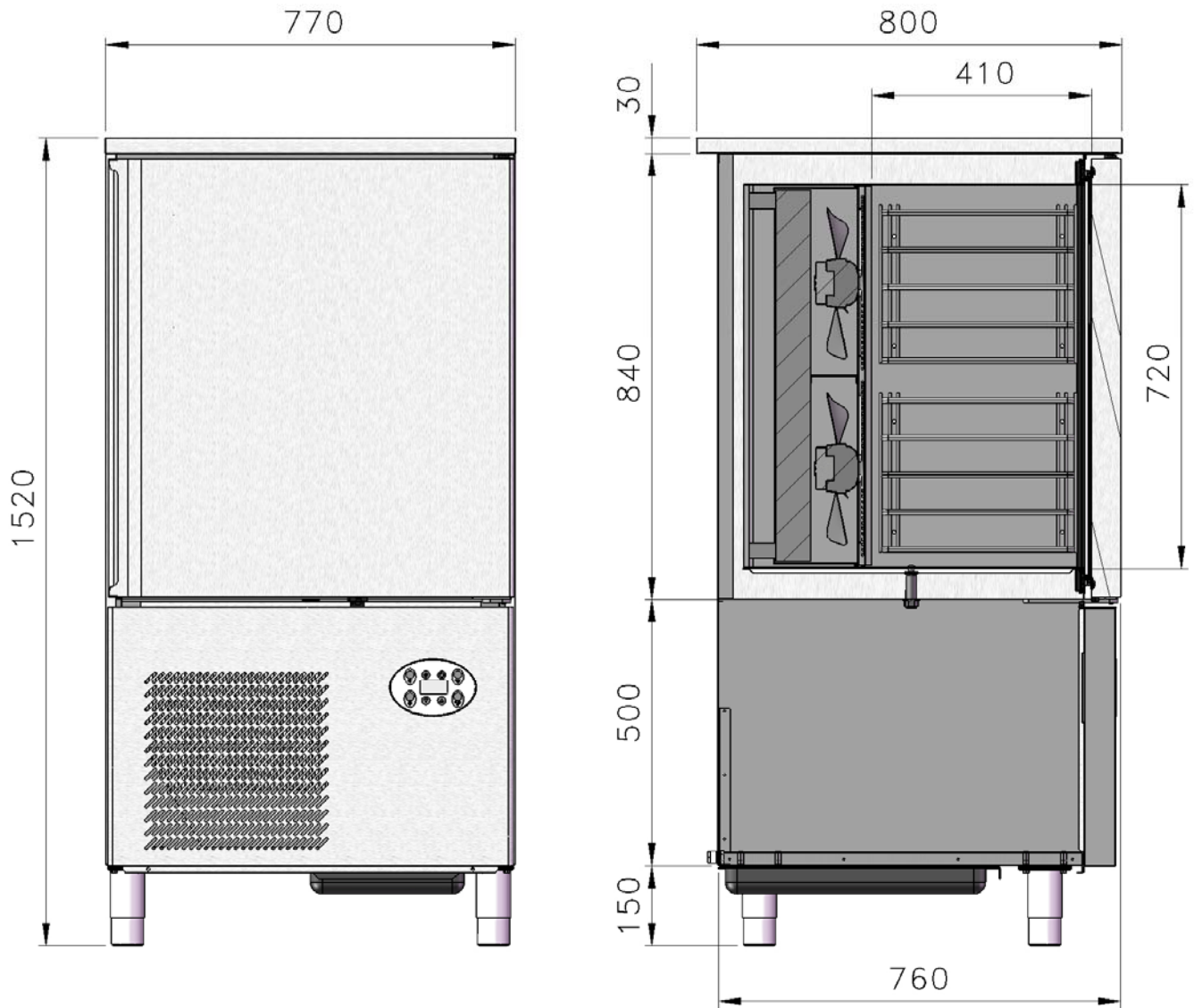

### 14. ALEXANDER 10T EXPLODED VIEW

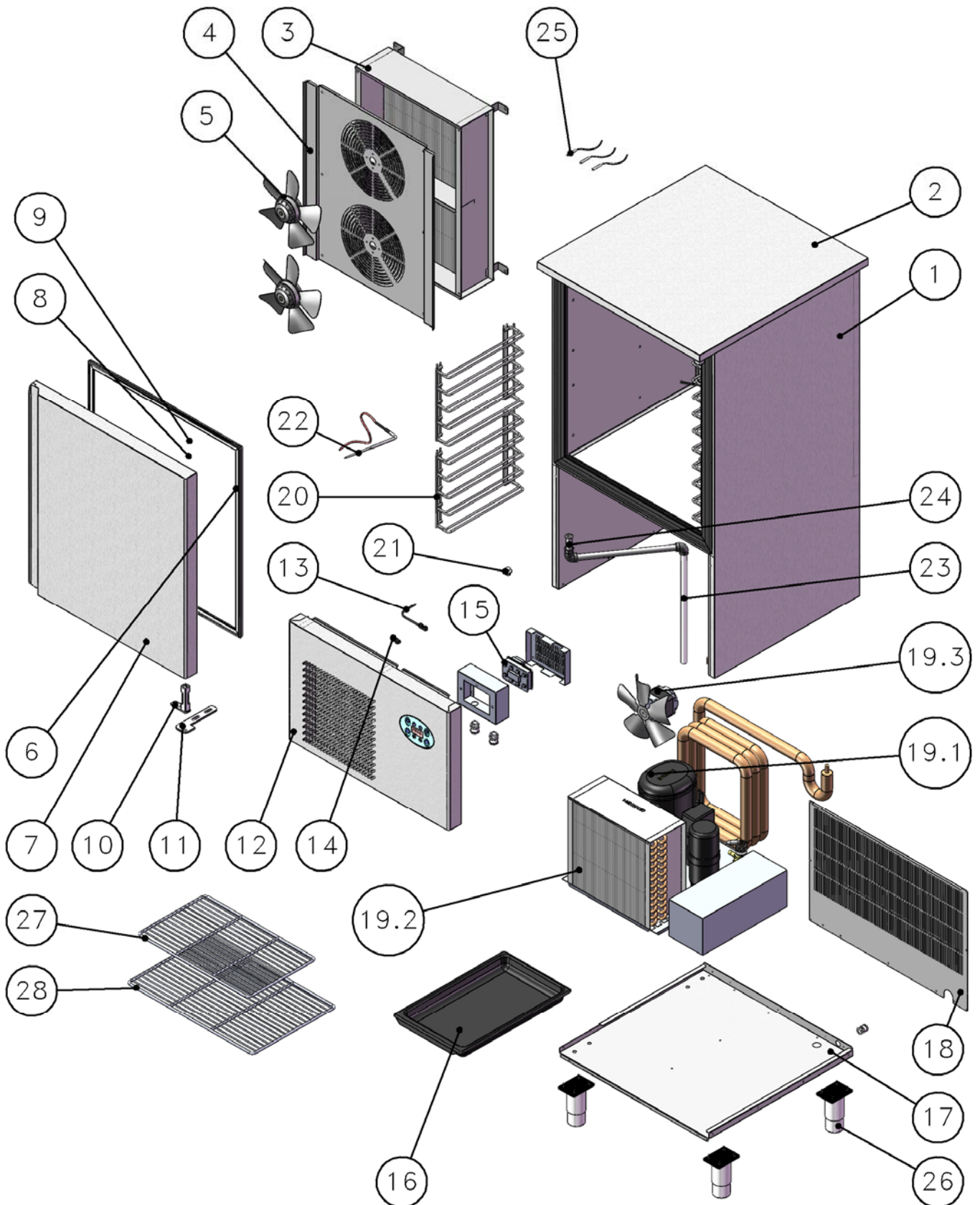



## 15. SPARE PARTS ALEXANDER 10T LIST

Pos.	Codice	Descrizione	Qta
1	63600380	INSULATED BODY 10 T	1
2	63600249	WORKING TOP	1
3	64860170	EVAPORATOR	1
4	62454315	SUPPORT STEEL EVAPORATOR FAN	1
5	64840101	EVAPORATOR FAN	2
6	64691100	MAGNETIC GASKET	1
7	63600385	INSULATED DOOR 10 T	1
8	64700130	BEARING IN PVC	1
9	62500250	SUPERIOR DOOR HINGE	1
10	64700128	LOWER TWISTING HINGR	1
11	62500130	INFERIOR DOOR HINGE	1
12	62454300	ELECTRICAL SWITCH PANEL	1
13	64740096	DOOR MICRO-SWITCH	1
14	64740098	DOOR MICRO-SWITCH	1
15	64740178	TEMPERATURE CONTROL DEVICE	1
16	64740105	DEFROSTING WATER TANK	1
17	62454290	BOTTOM	1
18	62454325	BACK COVER STEEL	1
19.1	64850150	COMPRESSOR	1
19.2	64840140	CONDENSER	1
19.3	64840110	CONDENSER FAN MOTOR	1
20	64700112	TRAY HOLDER FRAME	4
21	64700198	PLUG	1
22	64740160	PIN PROBE	1
23	64700228	DISCHARGE	1
24	64700213	DISCHARGE Ø20x75	1
25	64740165	PTC PROBE	3
26	64700063	ADJUSTABLE FOOT 145 - 195	4
27	64700091	GRATE 530x325	1
28	64700092	GRATE 600x400	1

# 16. WIRING DIAGRAM ALEXANDER 10T

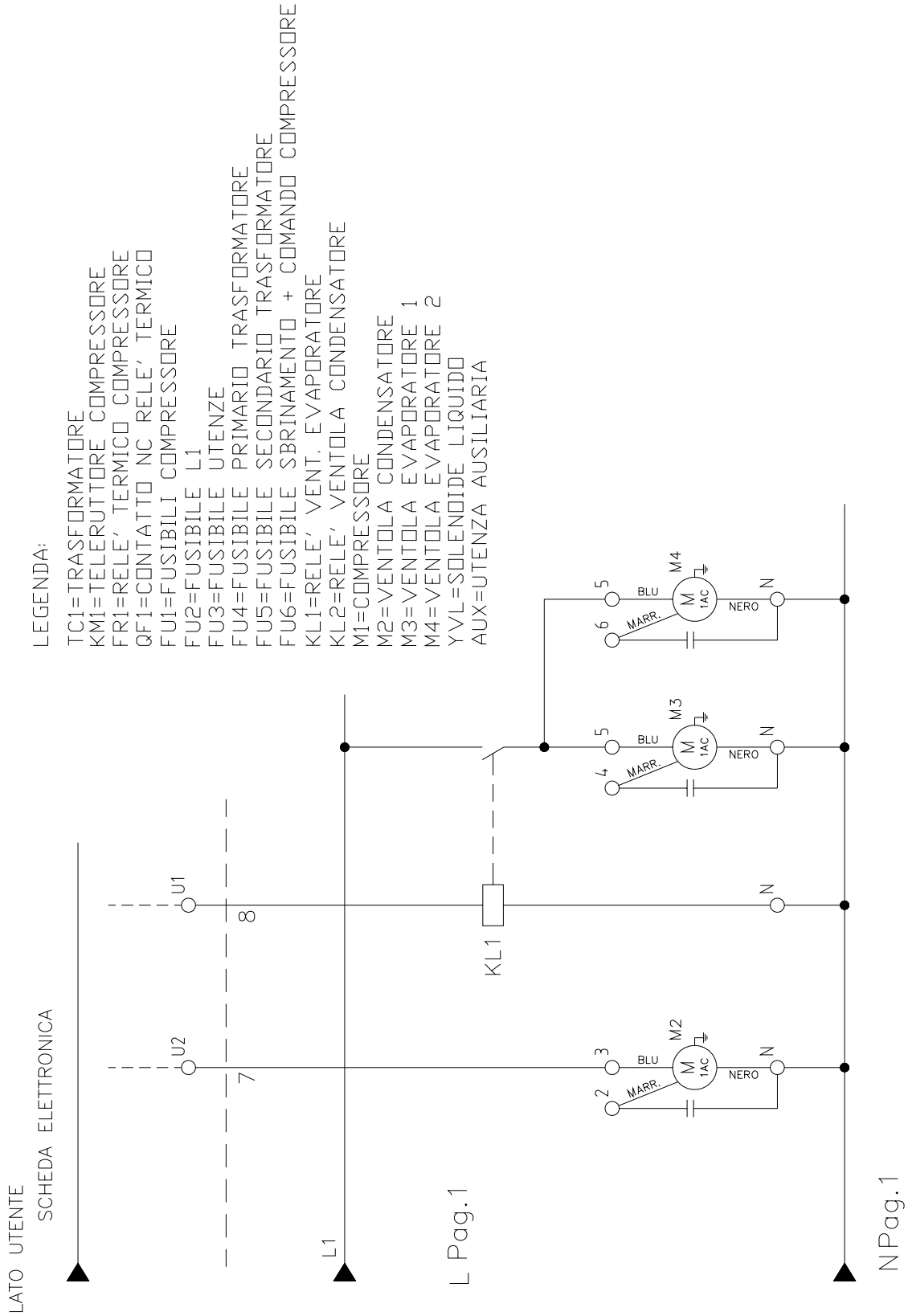

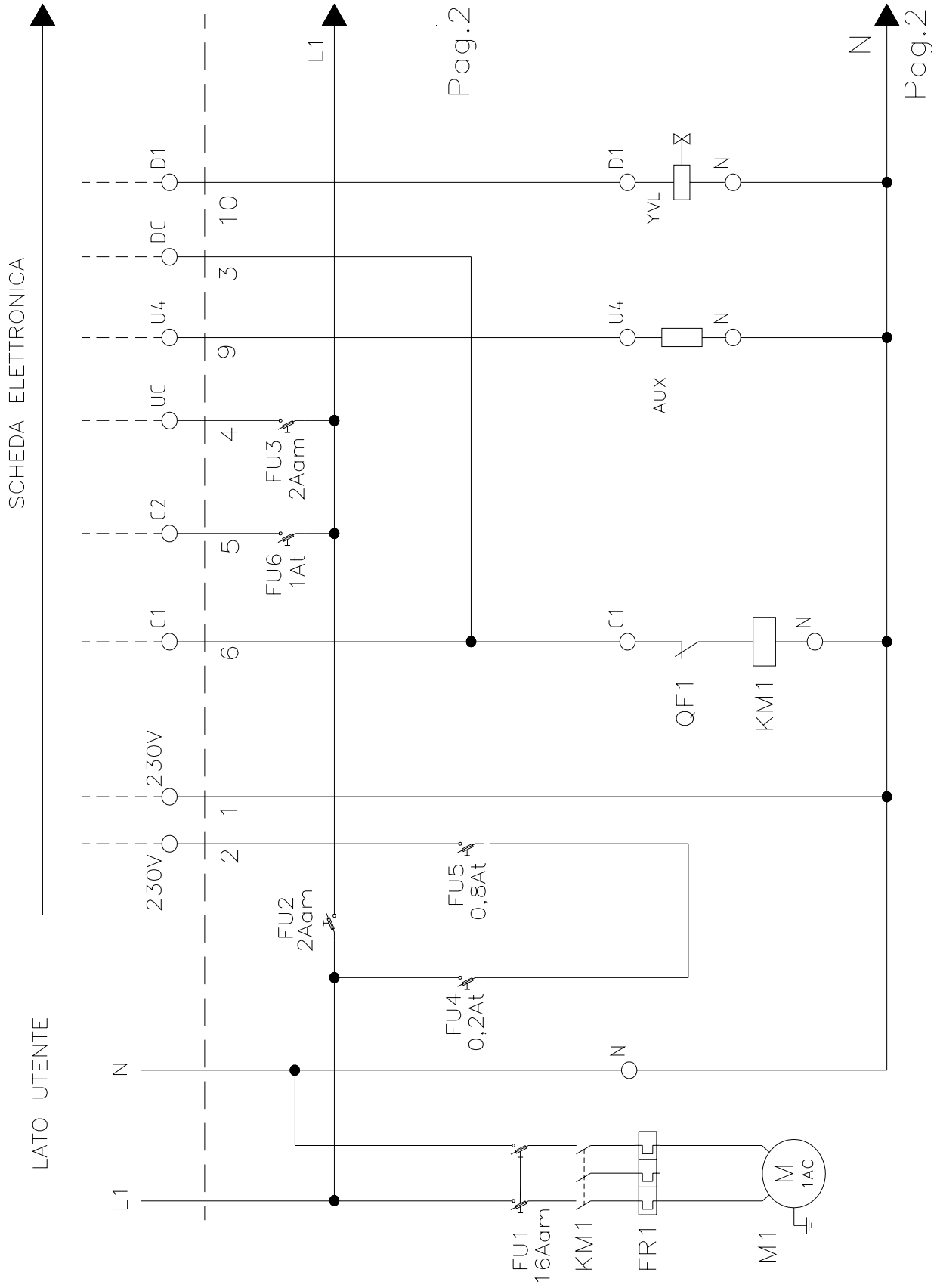

Pag.2

Pag.2

# ALEXANDER 15T

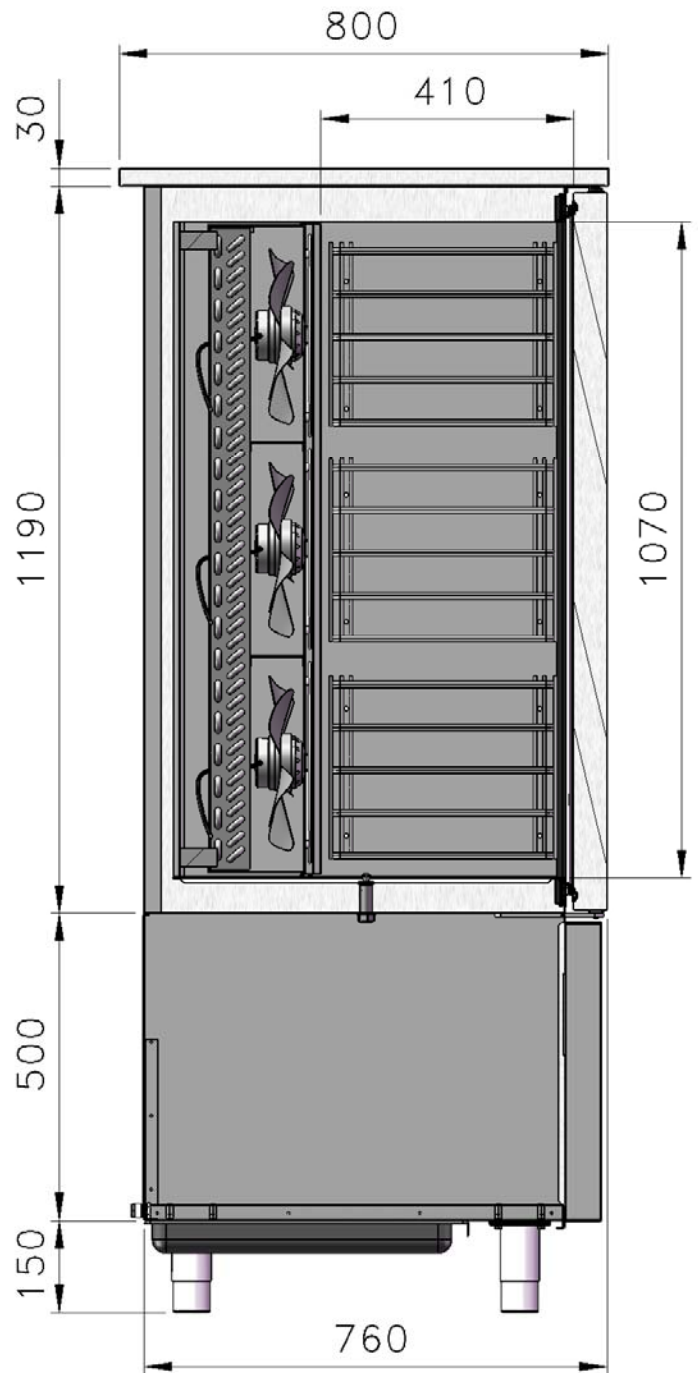
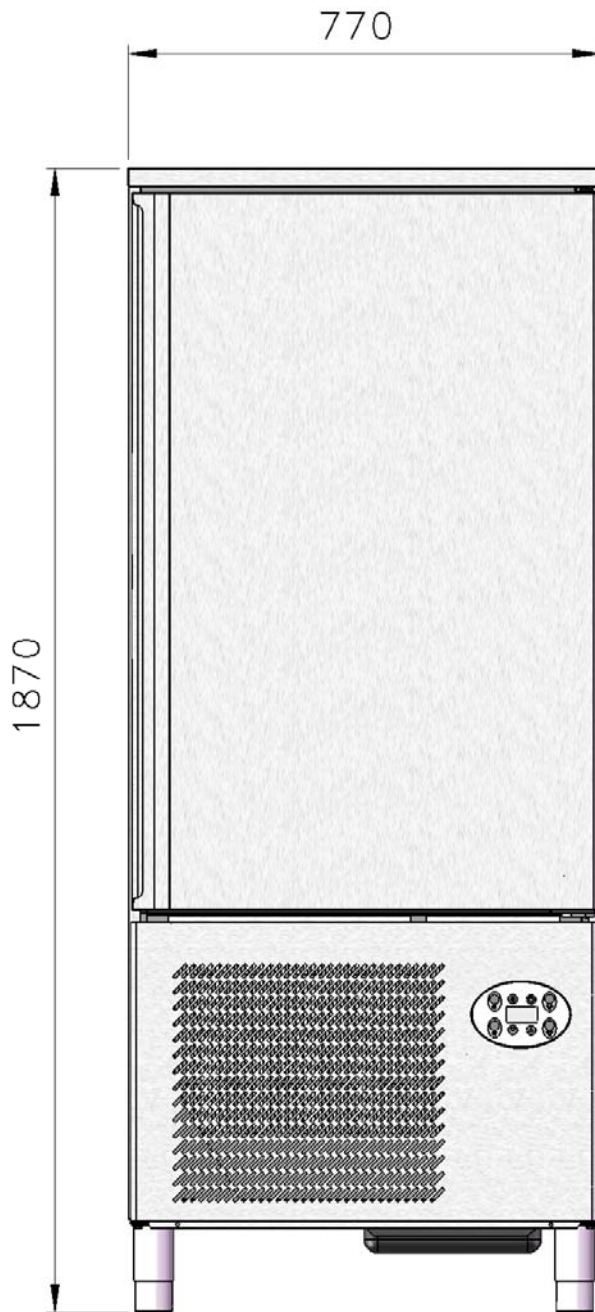

### 17. ALEXANDER 15T EXPLODED VIEW

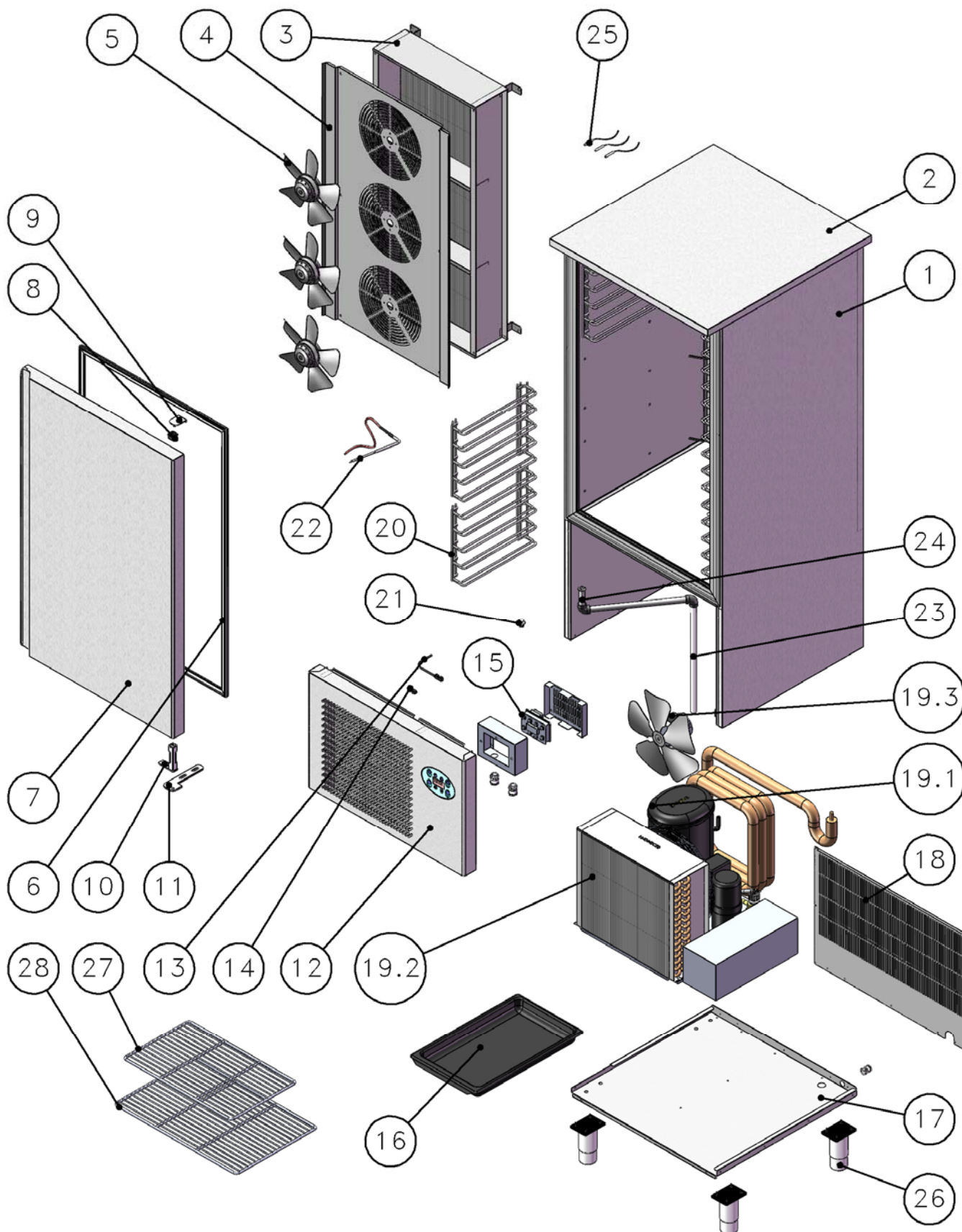

## 18. SPARE PARTS ALEXANDER 15T LIST

Pos.	Codice	Descrizione	Qta
1	63600390	INSULATED BODY 15 T	1
2	63600249	WORKING TOP	1
3	64860175	EVAPORATOR	1
4	62454320	SUPPORT STEEL EVAPORATOR FAN	1
5	64840101	EVAPORATOR FAN	2
6	64691105	MAGNETIC GASKET	1
7	63600395	INSULATED DOOR 15 T	1
8	64700133	BEARING IN PVC	1
9	62500250	SUPERIOR DOOR HINGE	1
10	64700128	LOWER TWISTING HINGR	1
11	62500130	INFERIOR DOOR HINGE	1
12	62454305	ELECTRICAL SWITCH PANEL	1
13	64740096	DOOR MICRO-SWITCH	1
14	64740098	DOOR MICRO-SWITCH	1
15	64740178	TEMPERATURE CONTROL DEVICE	1
16	64740105	DEFROSTING WATER TANK	1
17	62454290	BOTTOM	1
18	62454325	BACK COVER STEEL	1
19.1	64850155	COMPRESSOR	1
19.2	64840160	CONDENSER	1
19.3	64840110	CONDENSER FAN MOTOR	1
20	64700112	TRAY HOLDER FRAME	4
21	64700198	PLUG	1
22	64740160	PIN PROBE	1
23	64700228	DISCHARGE	1
24	64700213	DISCHARGE Ø20x75	1
25	64740165	PTC PROBE	3
26	64700063	ADJUSTABLE FOOT 145 - 195	4
27	64700091	GRATE 530x325	1
28	64700092	GRATE 600x400	1

# 19. WIRING DIAGRAM ALEXANDER 15T

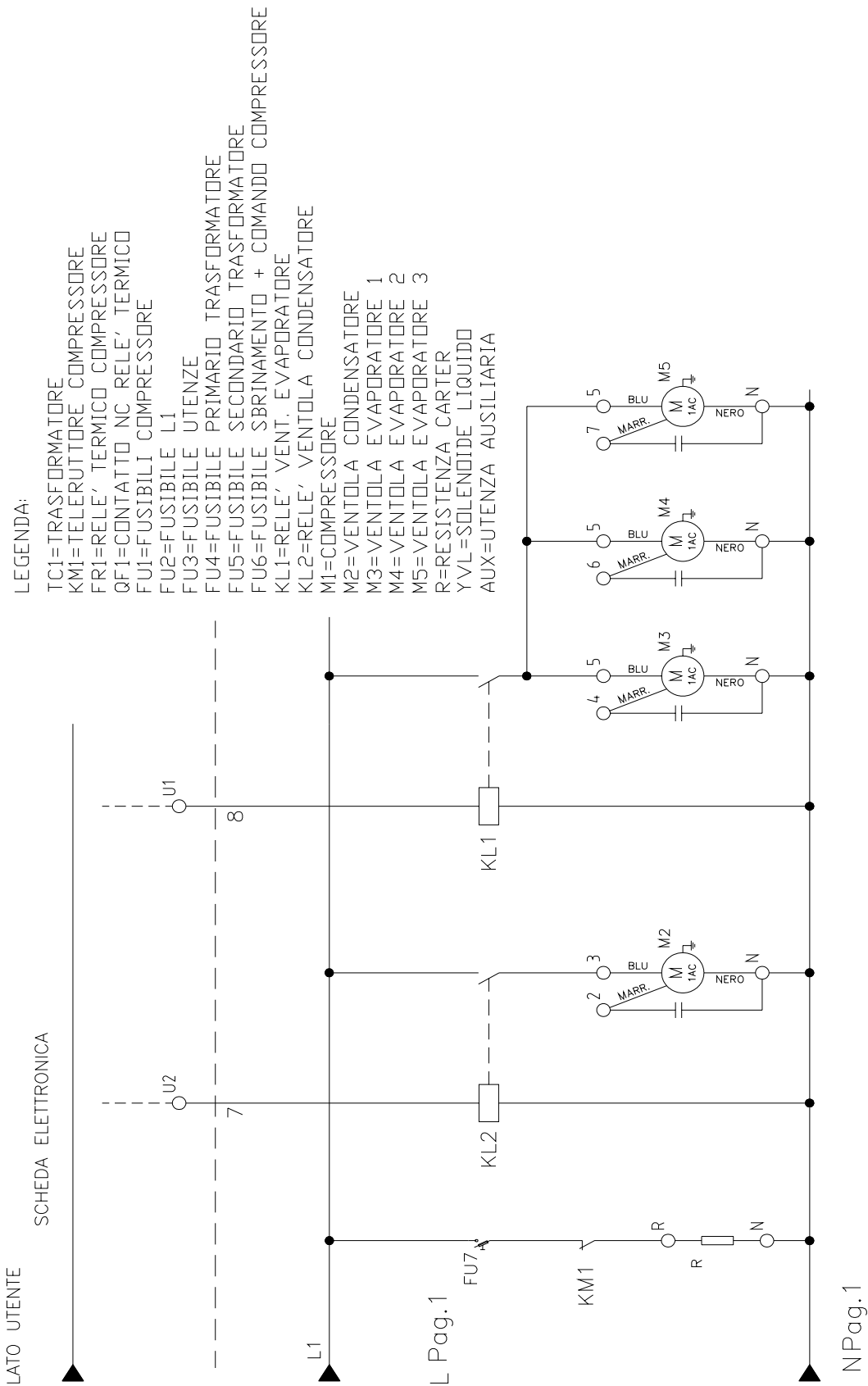

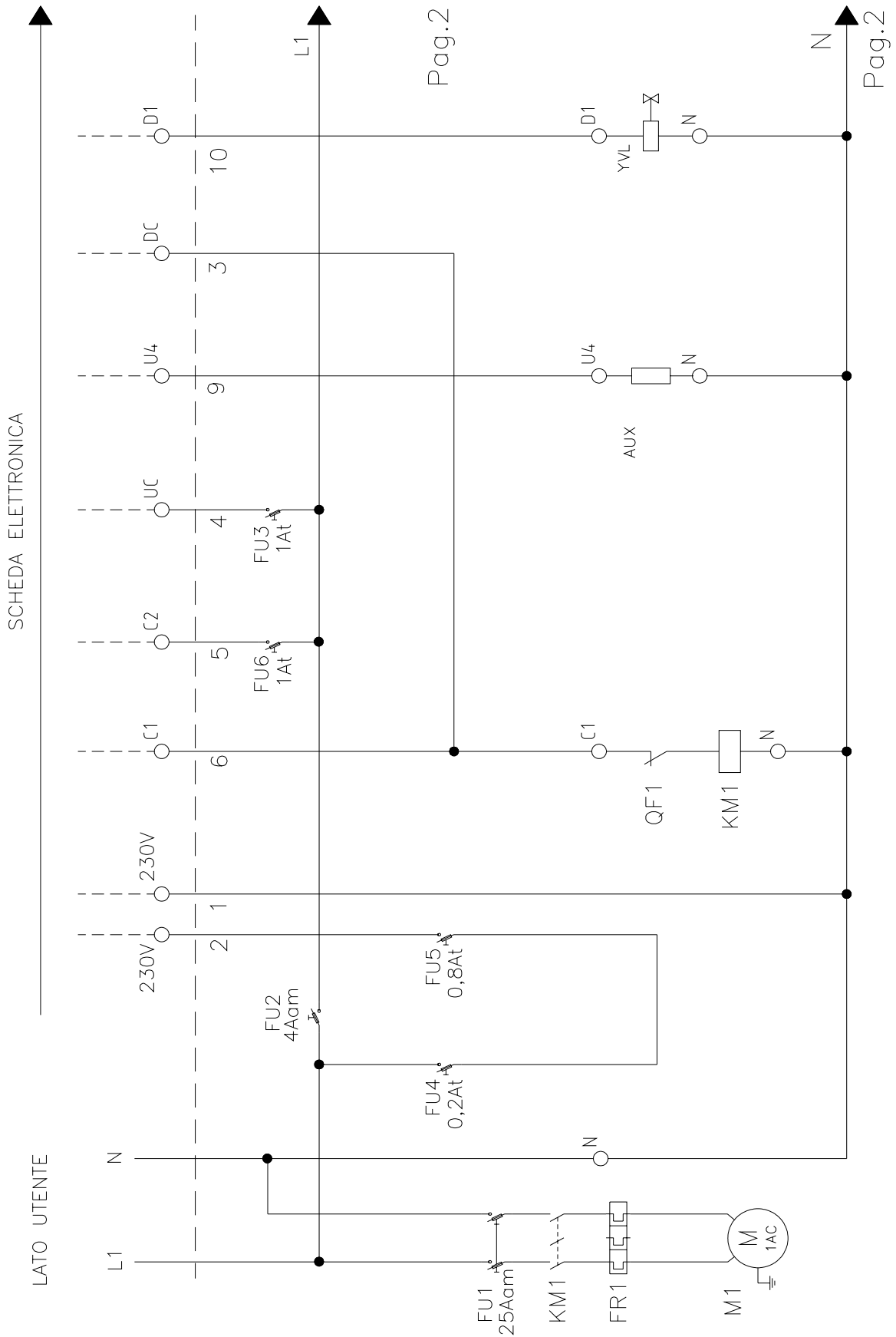



## **NOTES**

Lined area for notes, consisting of approximately 35 horizontal lines.

# Blast Chiller Operating Instructions





## 7.3 SOFT Time Chilling

How to use the SOFT time chilling function:



0. Turn on the blast chiller pushing for 5 seconds the START button

1. Insert the probe in the food

2. Push 2 times the CHILL button  after 1 second the screen shows the time cycle set point (90 min). Such value can be changed pushing

the decrease/increase buttons  .

3. Push again the CHILL button  to see the pre-set temperature for the cycle (-5°C). Set the desired working temperature through the

increase/decrease buttons  .

4. Start the working cycle pressing the START button .

5. The screen shows the remaining time until the cycle end. The cycle ends when the set time as duration of chilling phase has passed.

6. It automatically starts the preservation phase.

During time chilling phase it is always possible to visualize the probe temperature

pushing the CHILL button . In that way, screen will show for 5 seconds the probe temperature. In that way, screen will show for 5 seconds the probe temperature.

# Blast Chiller Operating Instructions







## 7.4 HARD Time Chilling

How to use the HARD time chilling function:

0. Turn on the blast chiller pushing for 5 seconds the START button

1. Insert the probe in the food

2. Push 2 times the CHILL button : after 1 second the screen shows the time cycle set point (90 min). Such value can be changed pushing the decrease/increase buttons  .

3. Push again the CHILL button  to see the pre-set temperature for the cycle (-5°C). Set the desired working temperature through the increase/decrease buttons  .

4. Push the HARD button  to activate the HARD time chilling function.

5. Start the working cycle pressing the START button .

6. The screen shows the remaining time until the cycle end. The cycle ends when the set time as duration of chilling phase has passed.

7. It automatically starts the preservation phase.

During time chilling phase it is always possible to visualize the probe

temperature pushing the CHILL button . In that way, screen will show for 5 seconds the probe temperature.

# Blast Freezing Operating Instructions



## 7.6 TEMPERATURE Freezing

How to use the TIME freezing function:

0. Turn on the blast chiller pushing for 5 seconds the START button

1. Insert the probe in the food

2. Push 2 times the FREEZE button



After 1 second the screen shows the time set point of the cycle (240 min.). Such

value can be changed pushing the increase/decrease buttons



3. Start the working cycle pressing the START button



4. The time freezing cycle ends when the time set as freezing duration has passed .

5. It automatically starts the preservation phase.

During time freezing phase it is always possible to visualize the probe temperature

pushing the CHILL button



In that way, screen will show for 5 seconds the probe temperature.

Press the START button



when you want to remove food from the blast chiller.

# Blast Chiller Operating Instructions



## 7.1 SOFT Temperature Chilling

How to use the SOFT temperature chilling function:

0. Turn on the blast chiller pushing for 5 seconds the START button
1. Insert the probe in the food

2. Push the CHILL button



After 1 second the screen shows the temperature set point of the cell during blast chilling function ( $-5^{\circ}\text{C}$ ). Such value can be changed pushing the

increase/decrease buttons



3. Start the working cycle pressing the START button
4. The chilling cycle ends when the probe achieves the temperature of  $+3^{\circ}\text{C}$ .
5. It automatically starts the preservation phase.





# Blast Chiller Operating Instructions



## **7.2 HARD Temperature Chilling**

How to use the HARD temperature chilling function:

0. Turn on the blast chiller pushing for 5 seconds the START button
1. Insert the probe in the food

2. Push the CHILL button  After 1 second the screen shows the temperature set point of the cell during the chilling function (-5°C). Such value can be changed pushing the increase/decrease buttons  .

3. Push the HARD button  to activate the HARD temperature chilling function.

4. Start the working cycle pressing the START button 

5. The blast chilling cycle ends when the probe achieves the temperature of +3°C.

6. It automatically starts the preservation phase.

During temperature chilling phase it is always possible to visualize the probe temperature pushing the CHILL button . In that way, screen will show for 5 seconds the probe temperature.

Press the START button  when you want to remove food from the blast chiller.

# Blast Freezing Operating Instructions



## **7.5 TEMPERATURE Freezing**

How to use the TEMPERATURE freezing function:

0. Turn on the blast chiller pushing for 5 seconds the START button

1. Insert the probe in the food

2 Push the FREEZE button



After 1 second the screen shows the temperature set point of the cell during chilling function (-38°C). Such value can be changed pushing the

increase/decrease buttons



3. Start the working cycle pressing the START button



4. The freezing cycle ends when the probe achieves the temperature of -18°C.

5. It automatically starts the preservation phase.

During temperature freezing phase it is always possible to visualize the probe

temperature pushing the CHILL button



In that way, screen will show for 5 seconds the probe temperature.

Press the START button



when you want to remove food from the blast chiller.