



UTENSIL WASHING MACHINES



UP(T)/UX(T) SERIES

INSTALLATION AND OPERATION INSTRUCTIONS

(original instructions)

Starting from Serial No.:
8664 0001

REV. 25.07.2011

IMPORTANT NOTES

USE IN ACCORDANCE WITH REGULATIONS:

The machine is technical work equipment for express use in the work place.

The machine is exclusively to be used to wash ware such as pots and pans, baking sheets, cutlery, trays etc.

Do not use for electrically heated cooking and heat conservation appliances.

Do not put heavy objects on the top of the machine.

SAFETY:

Never hose down the machine.

Do not stand on the open front door of the machine.



**The “Attention” symbol is shown beside instructions that are essential for the safe operation of the machine.
Please read these passages thoroughly.**

LIABILITY:

Installations and repairs which are carried out by non-authorized technicians or the use of other than original spare parts, and any technical alterations to the machine, may affect the warranty set out in the standard conditions of sale.

MACHINE NOISE LEVEL:

The machine noise level is < 68 dB (A).

CONNECTING TENSIONS:

The machine described in this operation manual has following connecting tensions:
400 V/50 Hz/3 Ph/N/PE.

1. INSTALLATION	5
1.1. Location	5
1.2. Reduction of door opening height	6
1.3. Electrical Connection	7
1.4. Water Connection	8
1.5. Steam Connection (Steam-Heated Machines Only)	8
1.6. Adjustment of Shut-off Valve for Steam Supply	9
1.7. Drain Connection	9
2. DISPENSER CONNECTION	10
3. CONTROLS	12
4. START UP	13
4.1. Detergent	13
4.2. Rinse Aid	13
4.3. Chemical Deficiency Sensor	13
4.4. Priming the Suction Hoses	14
4.5. Softener (Optional).....	15
5. OPERATION	16
5.1. Preparation	16
5.2. Run	17
5.3. Select Program	18
6. SWITCH-OFF AND CLEANING THE MACHINE.....	19
6.1. Switch-off.....	19
6.2. Cleaning (Daily).....	19
6.3. Cleaning (Weekly)	19
6.4. Hygiene Cycle	20
7. TEMPERATURE PREVIEW	21
8. FAULTS/INDICATIONS.....	22
9. SETTINGS AND COUNTER VALUES.....	23
9.1. Adjustment of Detergent Dosage Quantity	23
9.2. Adjustment of Rinse Aid Dosage Quantity	23
9.3. Adjustment of Water Hardness.....	24
9.4. Cycle Counter	24
9.5. Water Consumption Counter	24
9.6. Activation/Deactivation of Acoustic Signals.....	25
9.7. Activation/Deactivation of Chemical Sensor	25
9.8. Control of the Detergent Dosage Pump	25
9.9. Control of the Rinse Aid Dosage Pump Display CH2	26

9.10. Termination of Setting Mode/Counter Display	26
10. FROST PREVENTION	27
11. MAINTENANCE	28
12. TROUBLESHOOTING GUIDE	29
12.1. Poor Wash Result	29
12.2. Other Malfunctions.....	30

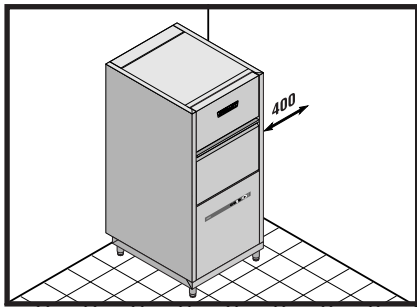

1.1. LOCATION

- Wall clearance is not required at the rear.
- The lateral distance between machine and wall should be at least 400 mm on one side.
- To avoid damage of the feet, do not slide the machine on floor after the skid is removed.
- Level machine by turning the feet.
- Distribute machine weight equally onto all feet.

1. INSTALLATION

1.2. REDUCTION OF DOOR OPENING HEIGHT

With standard setting the upper part of the split door opens to a height of 2417 mm. This can be limited to 2200 mm by the following adjustment of the mechanism of the door.

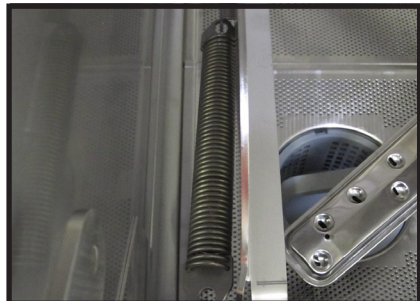

- Completely remove both springs (right/left). These are no longer required.
- The mounting points of the door joining rods must now be changed.



Attention:

To prevent the upper sliding door from falling down, this alteration must be done in two steps so that the door remains supported on one side !

1.2.1. ALTERATION OF LEFT DOOR JOINING ROD



Photo shows positions before alteration.

- Loosen top and bottom screws of joining rod.

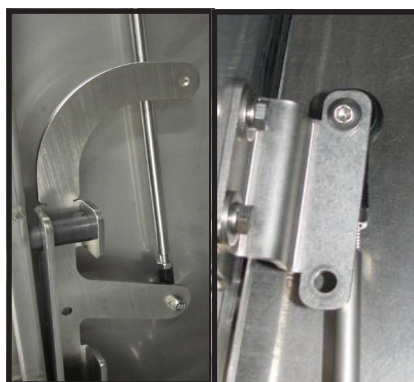

Photo shows new positions after alteration.

When altering the mounting point, the joining rod must again be mounted on the opposite side of the connection (between outer wall and mounting plate).

- Use the inner hexagon screw from the lower mounting point for the alternative upper mounting point.
- Use the outer hexagon screw from the upper mounting point for the alternative lower mounting point.

1.2.2. ALTERATION OF RIGHT DOOR JOINING ROD

Only after completing alteration of the left side, can the alteration of the right side be done in the same manner. Once again pay attention to the altered mounting points, the switching of the screws, as well as the positioning of the joining rod on the opposite side.

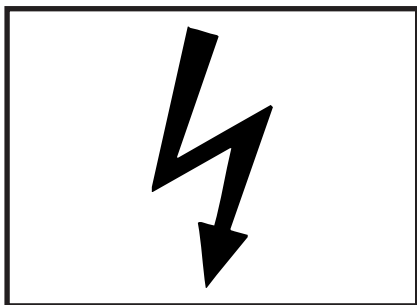

1.3. ELECTRICAL CONNECTION



Must be carried out by an authorized technician according to the local and national codes.

For Australia: in accordance with AS/NZS3500.1

- The electrical supply shall comply with the name-plate data.
- Modification to a different electrical supply is possible within the range of variations designated in the circuit diagram.
- Line fuses and cable cross section shall comply with the requirements.
- A cut-off device shall be provided to connect the supply cord (isolating switch or accessible plug device).

NOTE: According to EN 60 335 the appliance must be connected to an equipotential conductor. The connecting screw (⚡) is located at the rear of the floor pan beside the cable inlet.

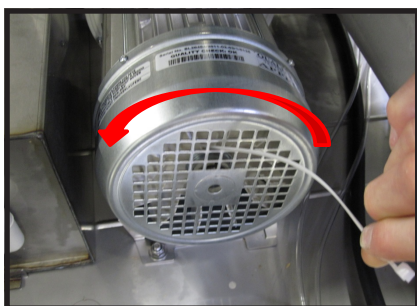

In order to verify the correct rotating-current phase connection, check the rotation of the wash pump as follows:

- Insert cable tie through the rear air grille (approx. 3 cm) and check if the fan impeller rotates counter-clockwise (in arrow direction). If not, exchange two of the three phases on the feed cable.

1. INSTALLATION

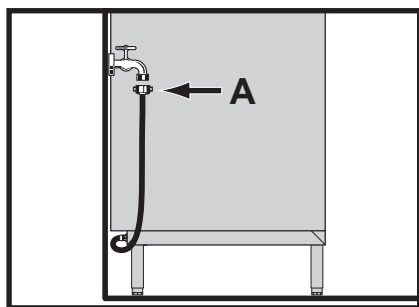

1.4. WATER CONNECTION



Must be carried out by an authorized technician according to the national and local codes.

The machine must be operated with potable water. For water with an extremely high mineral content, an external demineralisation is strongly recommended.

- Water temperature:
 - If possible, connect to warm water (max. 60 °C).
 - Machines with drainwater/exhaust heat recovery: If possible, connect to cold water (approx. 10 °C).
- Water hardness:
 - Machines without softener: max. 3.75° Clark = 0.5 mmol/l.
 - Machines with softener: max. 37.5° Clark = 5.3 mmol/l.
- **Special feature of PREMAX models:**
 - Additional separate warm water connection (marked red) for quicker filling of wash tank.
 - If the separate filling of the wash tank with warm water cannot be realized on site, a HOBART trained service technician must switch to booster filling via parameter adjustment S61 (value from 15 to 0).
- Line flow pressure:
 - Machines without softener: 0.5 - 10 bar
 - Machines with softener: 0.8 - 10 bar
 - If the line flow pressure is above 10 bar, provide pressure reducer at source.
- Connect the union nut “A” (3/4”) of the water supply hose to the site shut off valve.
- Do not kink or cut the supply hose.
- If an extended supply hose is required, use one of the same specifications as the original.

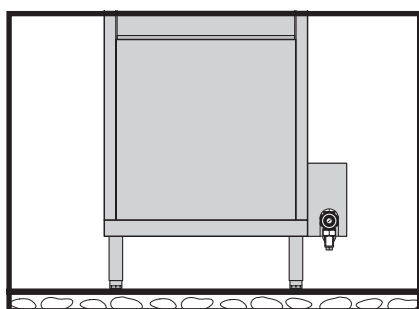

1.5. STEAM CONNECTION (STEAM-HEATED MACHINES ONLY)



Must be carried out by an authorized technician according to the local and national codes.

- Connection to steam supply (DN 20), 0.5 - 3.5 bar (max. 150 °C). See data plate!
- Dimension of steam and condensate piping has to be according to the requirements.
- The machine is equipped with all necessary fittings.
- Make sure that permissible pressures and temperatures will not be exceeded.

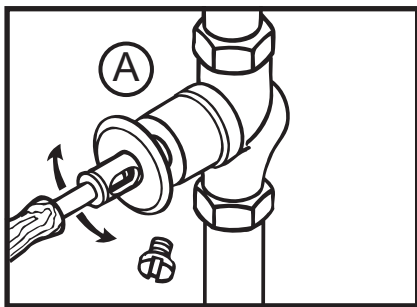

1.6. ADJUSTMENT OF SHUT-OFF VALVE FOR STEAM SUPPLY

- The built-in shut-off valve is equipped with an adjustment device (A) to limit the steam flow rate. A special tool is necessary for adjusting the valve-seat.



Attention:

The correct adjustment is very important particularly for higher pressure, and therefore must be done by a HOBART-trained service technician at first installation or after any changes are done at the customer site.

- The adjustment is correct if the heating-up time of the boiler is as long as the shortest wash cycle, while the valve is opened to maximum.
- If adjusted too far open pressure shocks may occur when the solenoid valve closes. This could cause damage at the installation. If adjusted too far close the required heating-power cannot be achieved.

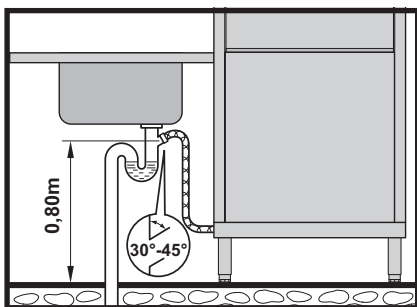

1.7. DRAIN CONNECTION

- Connection between machine and site drain must not exceed max. height of 0.80 m.
- Do not place the drain hose loosely on the floor (the hose could be rubbed through). Fix it at site!
- Do not kink the drain hose.

Generally, all models leaving the factory are equipped with integrated dispensers.

When retrofitting with other dispensers, please follow the instructions below.

**Attention:**

All below-mentioned steps must be carried out by service technicians qualified by Hobart.

Before removing the housing, make sure the machine is voltage-free. Make sure to observe all precautionary measures required when working near live components.

- Tank must be drained.
- Switch off main switch or unplug.
- Remove front panel.



To connect a liquid detergent dispenser:

- For rinse aid dosage, a dosage nipple is available on the top of the booster.
- Connect a hose (PVC / Ø 6 mm outside × Ø 4 mm inside) between outlet of the detergent pump and the detergent inlet (A) of the wash tank. Tighten with hose clamp.



- Install detergent pump or mount externally.

2. DISPENSER CONNECTION



- To connect a powder or solid detergent dispenser:
- Remove the rear panel.
 - Drill a hole through the inner tank wall appropriate to the required connection diameter (see fig.).
 - Screw the dosing connection tightly to the tank wall.

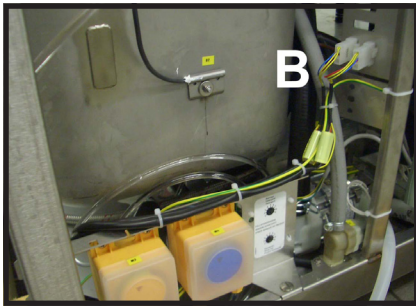

- Connect the plug (B) of the wire harness with the dosage pump (max. 100 VA).

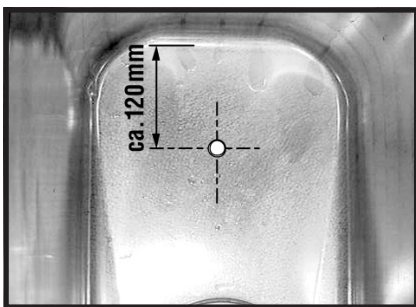

- Conductivity probe:
- Conductivity probe should be installed at the flat part of tank bottom (see fig.).
 - The hole size should be appropriate to the conductivity probe.

- Put panel(s) back into place.
- Switch on main switch at site or put the plug in.
- Dispenser and chemical sensor adjustment (see section 9.).

3. CONTROLS

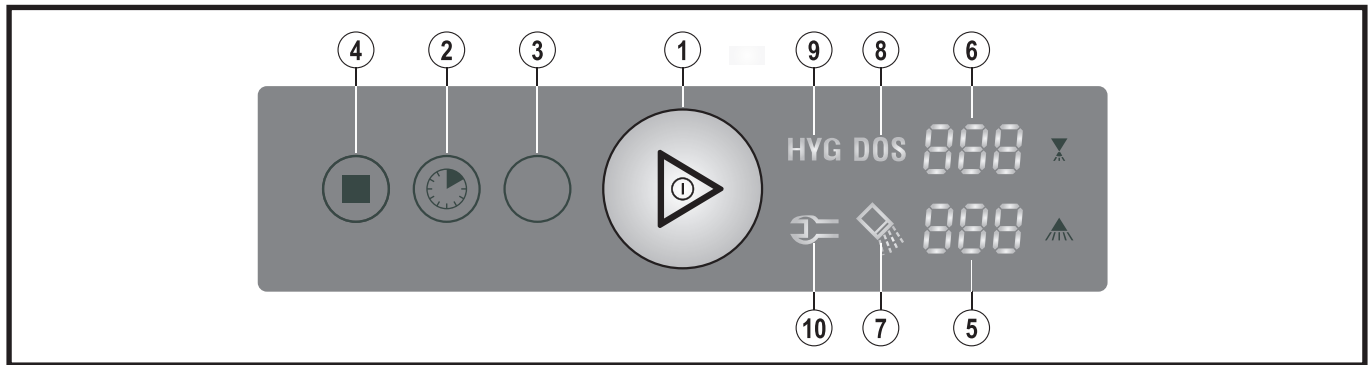

① **ON/OFF-button**

FUNCTIONS:

- Start machine: Push button.
- Start wash cycle: If the machine is ready for operation, Push button.
- Start automatic drain and self-cleaning cycle: Push Button and hold for 3 seconds. Thereafter, machine switches off automatically, but is not voltage free!

DISPLAYS:

The current machine mode is displayed by different colors.

- GREEN** = Machine is ready for operation
- BLUE** = Wash cycle is running
- RED** (permanently) = Failure indication (see section 8.)
- GREEN/RED** (alternating) = Failure indication (see section 8.)

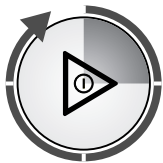

The status of the program is indicated by the color change of the four button segments.

- Filling increasingly GREEN
- Draining decreasingly GREEN
- Washing from BLUE back to GREEN

Optional:
Exhaust system active circling BLUE segment, background: GREEN

② **Program** button

Select between different preset programs: Push button.

Display ⑥ shows the selected program number and the corresponding run time (e.g. P02 240).

③

Only for PREMAX models UP/UPT:

Direct ON/OFF-switching of the Intensive cycle P03.

④ **Stop** button

In case of operating error or faults:
Switch off machine immediately (without draining): Push button.
After switch off, the machine is not voltage free!

⑤ Display e.g. temperature indication Wash (°C) (see section 7.)

⑥ Display e.g. temperature indication Rinse (°C) (see section 7.)

⑦ **Salt** required Insufficient regeneration salt in softener (if built-in)

⑧ **Detergent/Rinse Aid** indicator Detergent or rinse aid deficiency (if chemical sensor is activated)

⑨ **Hygiene** indicator Hygiene cleaning should be carried out (see section 6.4.).

⑩ **Service** indicator Machine operation is faulty (see section 8.).



Attention:
Head height of dosing pump: max. 1.5 m
Do not swap containers !
Use only commercial detergent and rinse aid. Please pay attention to the manufacturers safety instructions.

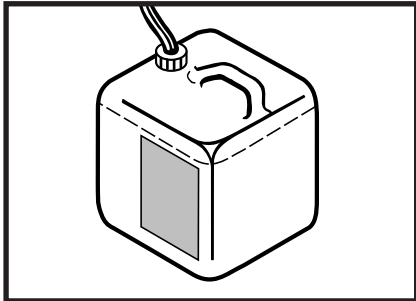

4.1. DETERGENT



Attention:
Do not use any acidic detergent products with the built-in detergent pump! (The ph-value has to be higher than 7.)!

- Place the suction hose into the bottom of the detergent container.
- Fill the suction hose according to section 4.4.

4.2. RINSE AID

- Place the suction hose (marked blue) into the bottom of the detergent container.
- Fill the suction hose according to section 4.4.

4.3. CHEMICAL DEFICIENCY SENSOR



Attention:
All below-mentioned steps must be carried out by service technicians qualified by Hobart.

Before removing the housing, make sure the machine is voltage-free. Make sure to observe all precautionary measures required when working near live components.

- Carry out hose filling SF1 and SF2 via the customer menu (see section 4.4.).
- Watch both hoses until the sensor-operated filling is completed.
- The control LEDs must light up. If necessary, readjust the potentiometers (increase setting).
 - Factory setting: potentiometer setting for detergent = 3
 - Factory setting: potentiometer setting for rinse aid = 5
- Activate the sensor by using CH = "1" in the customer menu (see section 9.7.).

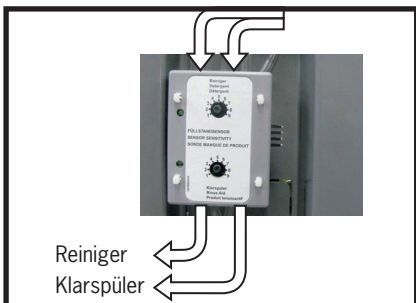

4.4. PRIMING THE SUCTION HOSES



Attention:
The machine has to be switched off.

Is carried out automatically if chemical sensor is activated, but will take several wash cycles. Therefore, we recommend manual hose priming as follows:

- Open the door.
- Push Stop button ④ and Program button ② simultaneously until
 - the upper display ⑥ shows “CH1” and
 - the lower display ⑤ shows “2.50”.
- Push Program button ② repeatedly, until
 - the upper display shows “d” and
 - the lower display shows “0”.
- Close the door.
 - The upper display shows “SF1”,
 - The lower display shows “0”.

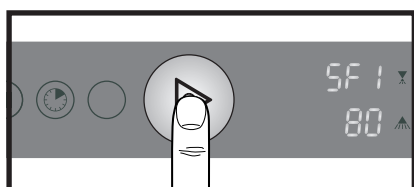
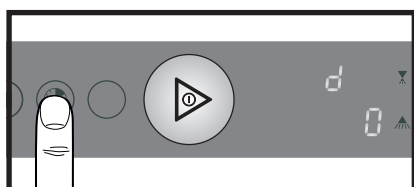
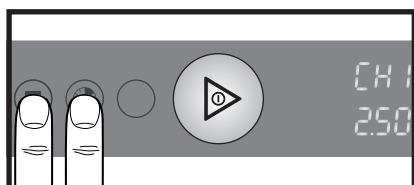

4.4.1. DETERGENT SUCTION HOSE

- Pushing the ON/OFF button ① activates the hose priming for 80 seconds.
- Check the fill level thereafter, and if necessary, repeat.
- Each cycle can be interrupted by pushing the ON/OFF button again.

4.4.2. RINSE AID SUCTION HOSE

- Push the Program button ②.
 - The upper display ⑥ shows “SF2”,
 - The lower display ⑤ shows “0”.
- Pushing the ON/OFF button ① activates the hose priming for 160 seconds.
- Check the fill level thereafter, and if necessary, repeat.
- Each cycle can be interrupted by pushing the ON/OFF button again

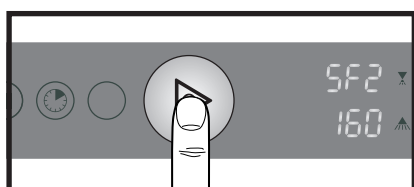
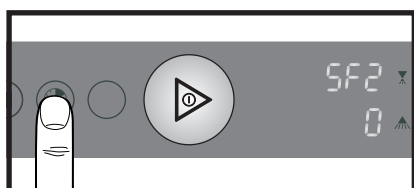

4.4.3. DETERGENT DIRECT INJECTION (UP/UPT ONLY)

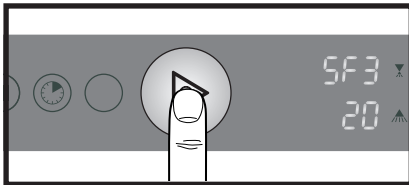
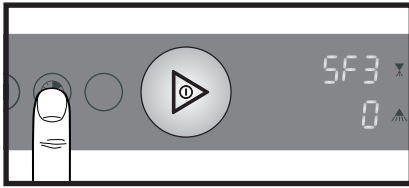

- Push the Program button ② again.
 - The upper display ⑥ shows "SF3",
 - The lower display ⑤ shows "0".
- Pushing the ON/OFF button ① activates the hose priming for 20 seconds.
- Check the fill level thereafter, and if necessary, repeat.
- Each cycle can be interrupted by pushing the ON/OFF button again.

4.4.4. TERMINATION OF HOSE PRIMING

- Open door and close it again, or do not press any button for 15 seconds!

4.5. SOFTENER (OPTIONAL)

NOTE: For the first run, the softener has to be filled with regeneration salt and potable water. In case an integral softener is not required, it should be completely deactivated by a service technician.



Attention:
Filling the salt reservoir with cleaning agent will damage the water softener.

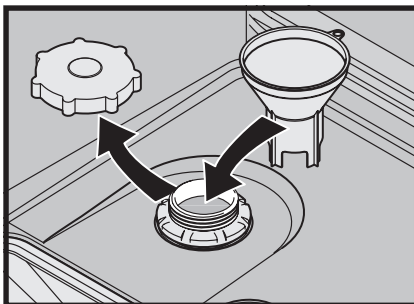

- Open the door.
- Unscrew the softener lid and fill with 2 kg of "Granular regeneration salt" using a funnel (do not use salt tablets).
- Fill up the softener with potable water (only at the first run).
- Clean seal and rim of softener lid carefully, before closing the lid.
- Close lid and tighten.



Attention:
In order to prevent corrosion it is necessary to remove any salt residues from tank bottom. After manual removal, start a wash cycle to completely eliminate any remaining salt residue.

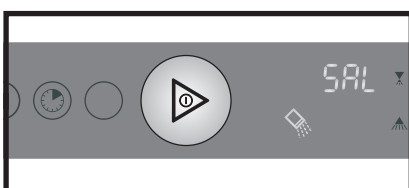

- Adjust the water hardness according to section 9.3.!
- When the Salt indicator ⑦ illuminates during operation, the softener has to be refilled with regeneration salt.
- There will be a slight delay before the salt light extinguishes after refill.

5. OPERATION

5.1. PREPARATION

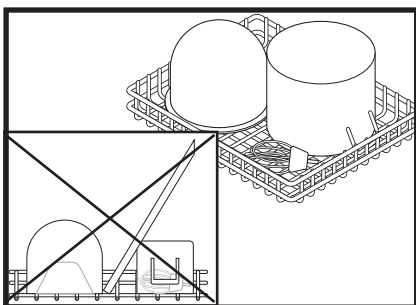
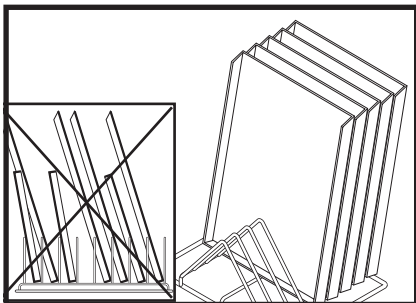
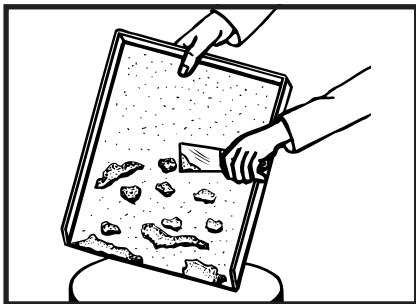
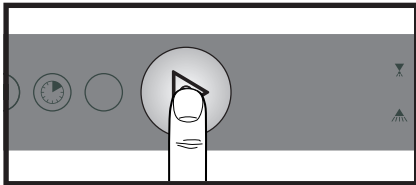
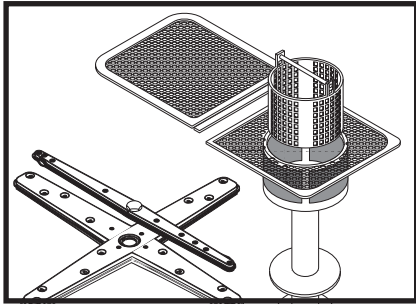

- Check correct position of wash/rinse arms and strainers.
 - Open shut-off valve.
 - Switch on main switch or put the plug in.
 - Check level of detergent and rinse aid containers.
-
- Close door and push the ON/OFF button ①; tank will be filled.
 - The ON/OFF button will become gradually green during fill and heating cycle. This process can take several minutes.
 - When the button becomes completely green, machine is ready for operation.
-
- Remove coarse food debris.
 - Remove foam-producing substances (albumins etc.)
 - Pre-treat hard, baked-on food debris (e.g. pre-soak).
-
- Insert baking sheets into the appropriate rack.
 - Avoid overlapping areas.
-
- Put pots and pans face downwards into the racks.
 - Protect light washware by covering with a rack or special weighted frame.



PREMAX MODEL UPT:

- GN-parts can also be placed in the guide rails of the additional lateral wash system.



Attention:

When using the lateral wash system, please note that the wash result is better in the center than on the outer edges.



- Racks can also be hung on the hooks of the additional lateral wash system.

5.2. RUN

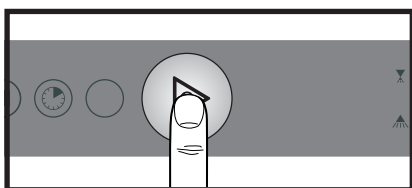

- Load machine and close the door.
- Push the ON/OFF button ①. During the running wash cycle, the color of the ON/OFF button changes from blue increasingly back to green.



Attention:

For PREMAX models UP/UPT, a soaking phase is integrated in the cycle. During this phase, the machine is silent.

- As soon as the ON/OFF button illuminates completely green, the wash cycle is finished.
- Open the door and take out rack. Allow washware enough time to dry.

MACHINES WITH EXHAUST HEAT RECOVERY (OPTIONAL):

- The ON/OFF button ① shows a circling blue segment on a green background as long as steam is exhausted from the machine. For high capacity requirements, it is not necessary to wait for this process to complete before continuing operation of the machine.

5.3. SELECT PROGRAM

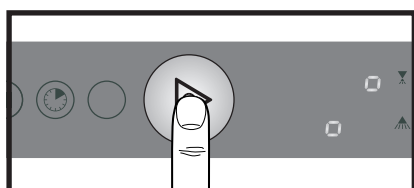
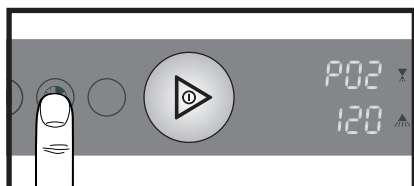

- The machine runs automatically using the Standard cycle program. If needed, it is possible to select a different program.
- To show the present program, push the Program button ① before starting the wash cycle. To change the program, push the Program button again. The theoretical runtime is then shown in the lower display.

P01 = Short cycle

P02 = Standard cycle

P03 = Intensive cycle

P04 = Continuous cycle

H = Hygiene cycle (see section 6.4.)

An operating Continuous cycle is shown by the running lights on the display. To stop the cycle, push the ON/OFF button ① (After 20 minutes the machine will stop automatically.). After a short break, rinse starts automatically.

The machine continues with the chosen cycle until it is switched off or another program is chosen.

PREMAX MODELS UP/UPT:

During Intensive cycle P03, a pre-soaking phase occurs using steam and detergent direct injection. For these models, the Intensive cycle P03 can also be selected directly by using button ③. Pushing button ③ again, switches the machine back to the Standard cycle.

6.1. SWITCH-OFF

- Close the door.
- Push and hold (approx. 3 seconds) the ON/OFF button ① until the first segment of the blue illuminated button goes out.

NOTE: During the drain cycle, the interior of the machine is cleaned automatically. A final inspection is recommended to remove any food debris.

If the interior of the machine is hosed down again manually, the residual water can be pumped out by pressing and holding down the ON/OFF button (3 seconds). On a machine which is already switched off, this starts a shortened drain cycle.

- When the ON/OFF button has gone out completely:
 - Switch off main switch or unplug and close the shut-off valve!

NOTE: If no button is pressed for 6 hours, the machine switches off automatically without draining.

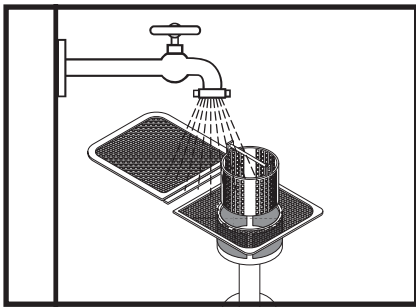

6.2. CLEANING (DAILY)



Attention:
Do not stand on the open front door of the machine.



Attention:
To clean the machine do not use any chloric, acidic or abrasive products and no metallic brushes.

- Open the door.
- Take out and clean strainers under running water. Please ensure that food debris does not enter pump intake!
- Clean interior of the machine.
- Put strainers back into place.
- Leave the door open for ventilation.

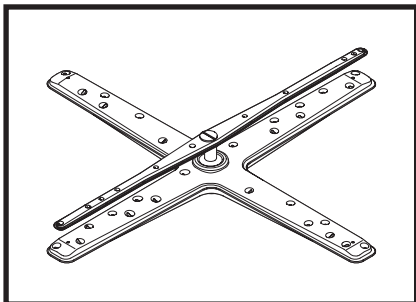

6.3. CLEANING (WEEKLY)

- Take out wash and rinse arms and flush.

6. SWITCH-OFF AND CLEANING THE MACHINE

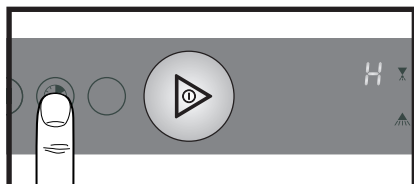
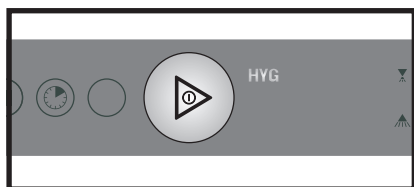

6.4. HYGIENE CYCLE

After reaching a pre-set number of wash cycles, the Hygiene indicator ⑨ lights up to indicate that an automatic hygiene cleaning of the machine interior should be carried out.

- Before end of operation: Put 6 (for UXT/UPT 10) HOBART-Hygiene-Cleaner Tabs into the machine interior.
- Close the door.
- Push Program button ② repeatedly until the upper display shows "H".
- Push ON/OFF button ①.

As the Hygiene cycle runs (duration dependent on model and water connection up to one hour), the green illuminated segments go out one after the other. At the end of the cycle, the machine switches off automatically.

- When the ON/OFF button has gone out completely:
 - Switch off main switch or unplug and close the shut-off valve!

NOTE: If necessary, hygiene cleaning should be carried out before reaching the pre-set number of wash cycles. With regular use, the machine interior will remain free of food debris and deposits.

7. TEMPERATURE PREVIEW

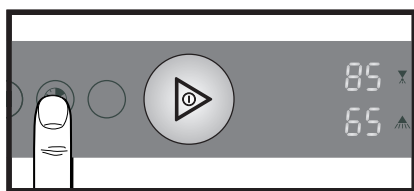

- Press and hold (3 seconds) the Program button ② until the actual temperatures (°C) are displayed (top = rinse, bottom = wash).

The indicators go out 10 seconds after releasing the Program button.

Permanent temperature display can be activated on request by the service technician.

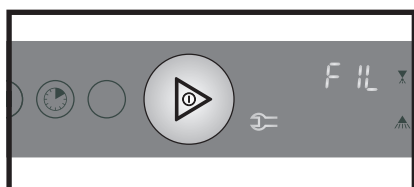

A code will be shown in the upper Display ⑥ (see table).

Die ON/OFF button ① flashes GREEN/RED alternately – restricted operation may be possible:

CODE	POSSIBLE CAUSE	MEASURES
AL	Drain hose is blocked.	Restart drain cycle. Clean drain hose if necessary.
HEI	Rinse booster heating defective.	Call the after sales service.
d 0	External demineralisation cartridge depleted.	Replace cartridge.
SAL	 Salt deficiency (only with built-in softener)	Refill the softener with granular regeneration salt.
CLOSE	Door is open during filling.	Close door.

Die ON/OFF-Button ① illuminates RED and the Service indicator ⑩ illuminates:

CODE	POSSIBLE CAUSE	MEASURES
FIL	Shut-off valve is closed.	Open shut-off valve at site and switch on machine again.
	Fill valve or fill system defective.	Call the after sales service.
SIE	Tank strainer not correctly positioned.	Put strainer correctly in place.
UL	Drain hose blocked.	Restart drain cycle. Clean drain hose if necessary.
	Fill system or drain system defective.	Call the after sales service.
F01	Temperature probe "rinse booster" defective.	Call the after sales service.
F02	Temperature probe "tank" defective.	Call the after sales service.
F03	Pressure transmitter "rinse booster" defective.	Call the after sales service.
F04	Pressure transmitter "tank" defective.	Call the after sales service.
CLOSE	Intensive cycle P03 interrupted.	Close door.

OTHER INDICATIONS

CODE	POSSIBLE CAUSE	MEASURES
CH1	DOS	Replace container. After container replacement, it can take several wash cycles until the indicator goes out. If required, hose priming should be carried out according to section 4.4.
CH2		

The ON/OFF button ① is flashing BLUE/RED alternately:

CODE	CAUSE	MEASURES
	Wash tank filters blocked.	Remove and flush strainers. Replace in machine, lower door to recommence wash cycle.



Attention:
The machine has to be switched off.

- Open the door.

If the door is closed, or if no button is pressed for 15 seconds, the indicator automatically switches off and the new settings will be saved.

Therefore, the setting procedure described below can be interrupted at any time.

9.1. ADJUSTMENT OF DETERGENT DOSAGE QUANTITY

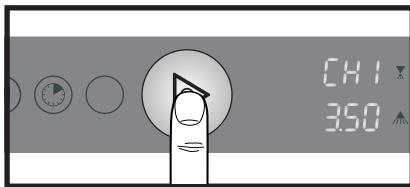
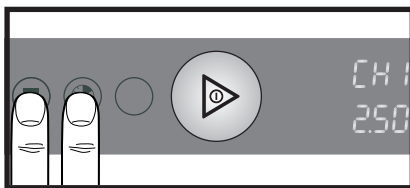

- Push Stop button ④ and Program button ② simultaneously until

- the upper display ⑥ shows “CH1” and
- the lower display ⑤ shows e.g. “2.50” pre-adjusted value of the detergent dosage = 2.50 g/l.

- To adjust the detergent dosage, push the ON/OFF button ① repeatedly, until the desired value (0.00 - 9.50 g/l) appears.

NOTE: Adjustment should be done in accordance with chemical supplier's recommendations.

PREMAX MODELS UP/UPT:

The dosage amount for the detergent direct injection cannot be changed.

9.2. ADJUSTMENT OF RINSE AID DOSAGE QUANTITY

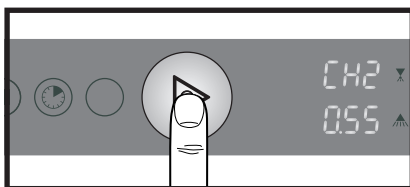
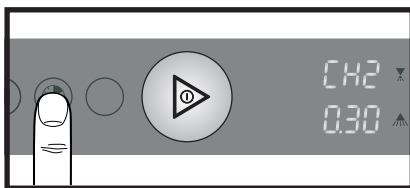

- Push Program button ② again.

- The upper display ⑥ shows “CH2”.
- The lower display ⑤ shows E.g.: “0.30” = pre-adjusted value of the rinse aid dosage time = 0.30 g/l.

- To adjust the rinse aid dosage, push the ON/OFF button ① repeatedly, until the desired value (0.00 - 2.00 g/l) appears.

NOTE: Adjustment should be done in accordance with chemical supplier's recommendations.

9. SETTINGS AND COUNTER VALUES

9.3. ADJUSTMENT OF WATER HARDNESS

With optional softener only.

To adjust the softener to the local water hardness (obtain details from local water authority).

- Push Program button ② again until
 - the upper display ⑥ shows “H04”.

- Push ON/OFF button ① repeatedly until the desired setting (H01-H04) appears.
 - H01 = up to 9°eh
 - H02 = 10 to 18°eh
 - H03 = 19 to 26°eh
 - H04 = 27 to 38°eh

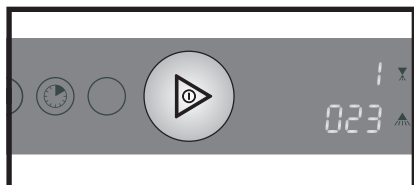
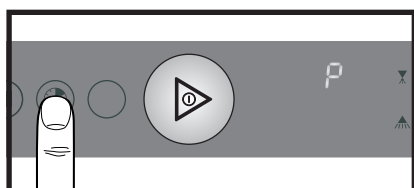
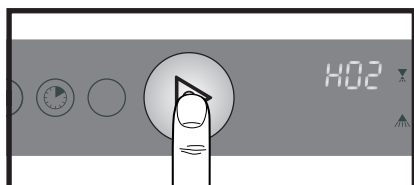
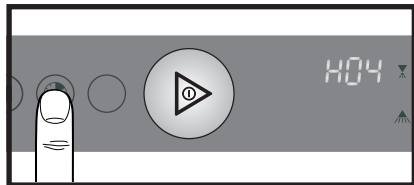

- Push Program button ② again.
 - The display will show alternately “P” or the number of wash cycles.
 - The lower display ⑤ shows the values from 1 to 999.

Thousands will be shown in the upper display ⑥.

- Example: 1023 wash cycles
- Max. Indication: 999 999

9.5. WATER CONSUMPTION COUNTER

- Push Program button ② again.
 - The display will show alternately “E” or the water consumption (liter).
 - The lower display ⑤ shows the values from 1 to 999.

Thousands will be shown in the upper display ⑥.

- Example: 10217 liter
- Max. Indication: 999 999

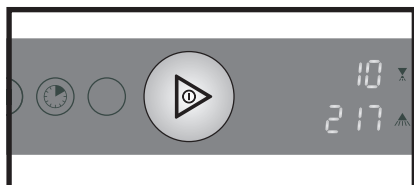
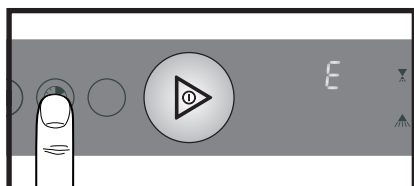

9.6. ACTIVATION/DEACTIVATION OF ACOUSTIC SIGNALS

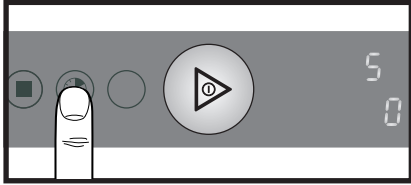

- Close the door.
 - The upper display ⑥ shows "SF1".
- Push Program button ② repeatedly until "S" is shown.
- By pushing the ON/OFF button ① acoustic signals can be activated/deactivated.
 - The lower display ⑤ shows "1" (activated) or. "0" (deactivated).

9.7. ACTIVATION/DEACTIVATION OF CHEMICAL SENSOR

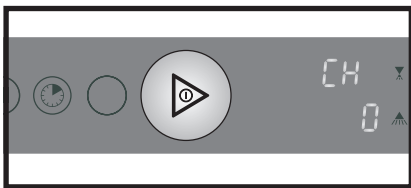

- Push Program button ② again.
 - The upper display ⑥ shows „CH“,
 - The lower display ⑤ shows the respective setting:
 „0“ = sensor deactivated
 „1“ = sensor activated for detergent and rinse aid
 „2“ = sensor activated for detergent
 „3“ = sensor activated for rinse aid

To adjust the setting:

- Push the ON/OFF button ① repeatedly until the desired setting appears.

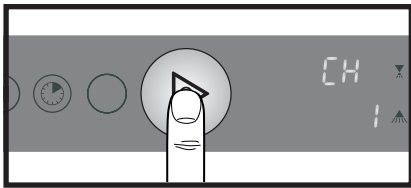

9.8. CONTROL OF THE DETERGENT DOSAGE PUMP

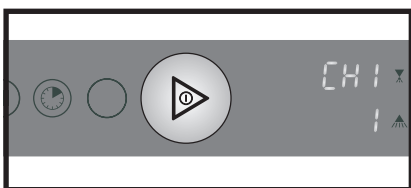

- Push Program button ② again.
 - The upper display ⑥ shows „CH1“,
 - The lower display ⑤ shows the respective setting:
 „0“ = not activated
 „1“ = activated, according to dosage setting
 „2“ = activated, setting parallel to rinse pump
 „3“ = activated, setting parallel to wash pump
 „4“ = activated, setting parallel to fill valve

To adjust the setting:

- Push the ON/OFF button ① repeatedly until the desired setting appears.

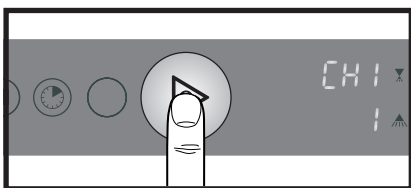

9. SETTINGS AND COUNTER VALUES

9.9. CONTROL OF THE RINSE AID DOSAGE PUMP DISPLAY CH2

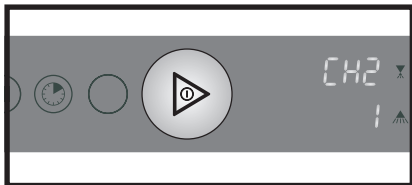

- Push Program button ② again.
 - The upper display ⑥ shows „CH2“,
 - The lower display ⑤ shows the respective setting:
 - „0“ = not activated
 - „1“ = activated, according to dosage setting
 - „2“ = activated, setting parallel to rinse pump
 - „3“ = activated, setting parallel to wash pump
 - „4“ = activated, setting parallel to fill valve

To adjust the setting:

- Push the ON/OFF button ① repeatedly until the desired setting appears.

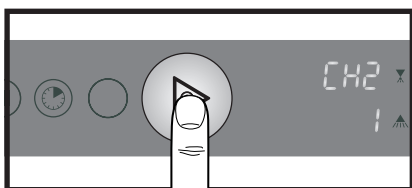

9.10. TERMINATION OF SETTING MODE/COUNTER DISPLAY

- Open the door and close it again, or do not press any button for 10 seconds.



Attention:
This should be only be carried out by an authorized service technician!

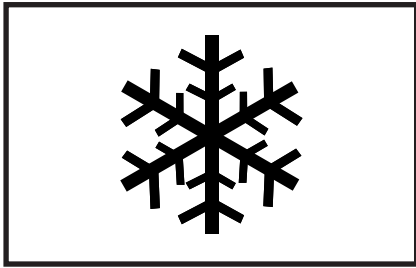

In case of frost or longer operation pauses (e.g. for seasonal operations) the machine must be completely drained.

Reset for operation according to section 12.

11. MAINTENANCE



In order to maintain the warranty, as well as a permanently safe, efficient, and trouble-free operation of the machine, the required maintenance must be carried out by authorized service technicians.

For this reason, we recommend the conclusion of an inspection and maintenance contract which assures qualified support by specially trained service technicians according to a time scheduled based on the operating conditions.

12.1. POOR WASH RESULT

TYPE OF FAILURE	POSSIBLE CAUSE	REMEDY
Washware is not clean.	Wash arms stiff (you should be able to turn them easily by hand).	Take out wash arms and clean them thoroughly. Check water outlet from machine to wash arms is clear.
	Wash arm nozzles are clogged (visual check).	Take out wash arm, remove cleaning cap and rinse wash arm thoroughly until soil is removed. Replace correctly.
	Rinse arm nozzles are clogged (possibly by lime deposit).	Remove rinse arms and decalcify them in separate container.
	Detergent concentration is too low or too high.	Check setting of detergent concentration.
	Coarse strainer soiled.	Take out strainer, empty and clean it.
	Fine strainer soiled or obstructed by lime.	Take out fine strainer. If heavily soiled soak in a vinegar solution. Then clean it thoroughly until the pores are free. Cleaning is to be done daily (see operating instructions).
	Wrong program selected for heavily soiled washware.	Select program with longer wash cycle.
Washware does not dry properly.	Rinse aid concentration too low.	Increase concentration (see instructions).
	Washware still greasy.	Detergent concentration too low: increase (see instructions). Check if detergent is appropriate. If not, choose a stronger one. Drain soiled water and refill machine. Check pre-scrapping procedure.
	Rack is not suitable for type of washware (sloping).	Use appropriate racks to create a sloping position which allows water to drain away from cavities.
	Washware stays too long in the machine at the end of program.	Take out washware as soon as cycle is completed to enable them to dry.

TYPE OF FAILURE	POSSIBLE CAUSE	REMEDY
Stripes and stains on washware.	Rinse aid concentration too high.	Reduce quantity (see instructions).
	Hard water or high mineral content.	Check water quality. Obtain details from local water authority. Recommended values: Ideal degree of hardness is 4° Clark. Ideal conductivity value for stainless steel items is max. 80 µS/cm and for washware max. 400 µS/cm.
	Rack is not suitable for type of washware (sloping).	Use appropriate racks to create a sloping position which allows water to drain away from cavities.
	Insufficient rinse aid concentration causes stains.	Increase quantity (see instructions).
	Machines with built-in softener: wrong type of salt used (e.g. tablets).	Use only granular regeneration salt.

12.2. OTHER MALFUNCTIONS

TYPE OF FAILURE	POSSIBLE CAUSE	REMEDY
During operation, machine becomes noticeably louder.	Excessive foaming due to inappropriate detergent or rinse aid.	Use appropriate detergent and rinse aid.
	Excessive foaming due to use of foaming-producing substances (albumins, etc.)	Thoroughly pre-treat washware.
Machine suddenly stops during wash program.	Machine is connected to a "maximum power supply unit" which cuts out the energy consumer at a given point, or machine is interlocked with another energy consumer unit.	Connect machine separately (call electrician).
	Blown site fuse.	Check site fuses.

HOBART GmbH
Robert-Bosch-Str. 17
77656 Offenburg
Tel. +49(0)781.600-0
Fax +49(0)781.600-23 19
E-Mail: info@hobart.de
Internet: www.hobart.de

As continued product improvement is a policy of HOBART,
specifications are subject to change without notice.