

Washer extractor

W575H

Features and benefits

- **Compass Pro[®] microprocessor offers:**
 - Large display and one control knob for easy program selection
 - Language selection
 - Quick selection and option buttons for the most frequently used wash programs and options
 - Wash program packages optimized on Economy, Performance and Time. (Available on general programs)
- **AS - Automatic Savings:**
 - The machine weighs the linen and adjusts the amount of water and energy according to the load. This leads to considerable savings in case the machine is not fully loaded. (Available on general programs)
- Extremely low water and energy consumption - see table below
- Four compartment detergent box for manual dosing of powder or liquid detergent
- High extraction force for efficient dewatering
- Door with gasket and strong hinges built for heavy duty operation
- Stainless and galvanized steel in all vital parts for high degree of rust protection
- **Power Balance:**
 - Maximises the extraction force, leading to highest dewatering and savings in drying
 - Minimizes the stress on the machine, leading to trouble-free operation and increased machine lifetime
 - Reduces vibrations, making it possible to install the machine in all locations



Images shown are a representation of the product only and variations may occur.

Main options

- Automatic liquid detergent supply (optional I/O board)
- Stainless steel front panel
- Connection to booking- /payment- system or coin meter
- Drain pump

Main specifications				W575H			
Max. capacity	filling factor 1:9	kg/lb		8/18			
Drum,	volume	litre		75			
	diameter	ø mm		520			
Extraction		rpm		1245			
G-factor				450			
Standard heating alternatives	electricity	kW		5.4 / 7.5			
Low energy heating alternatives	electricity	kW		2.0 / 3.0			
	steam			x			
	non-heated			x			
Consumption data "Normal 60°C"				EL		Steam***	
Economy*				Full load, 8 kg	Half load**, 4 kg	Full load, 8 kg	Half load**, 4 kg
Total time		min		47	44	47	44
Water consumption (cold+hot)		litre		50+12	26+7	62+0	33+0
Energy consumption (motor/heating/hot water)		kWh		0.15/0.35/0.75	0.15/0.25/0.45	0.15/-	0.15/-
Steam consumption		kg		-	-	1.65	1.05
Residual moisture		%		48	49	48	49

* Water temperature 15°C cold water and 65°C hot water.

** Programs with AS.

*** Depending on steam pressure.

Electrical connections*					
Heating alternative	Main voltage		Heating power kW	Total power kW	Recommended fuse A
		Hz			
Electric heated	220-240V 1 -	50/60	5.4/7.5	5.5/7.6	25/35
	220-240V 1 -	50/60	2.0/3.0	2.1/3.1	10/16
	220-240V 3 -	50/60	5.4/7.5	5.5/7.6	16/20
	220-240V 3 -	50/60	3.0/4.3	3.1/4.5	10/16
	380-415V 3N -	50/60	5.4/7.5	5.5/7.6	10/16
	380-415V 3N -	50/60	3.0/4.3	3.1/4.5	10
	440V 3 -	60	7.5	7.6	16
	480V 3 -	60	7.5	7.6	10
Steam or Non heated	220-480V 1 -	50/60	-	1.0	10

Water and steam connection		W575H
Water valves	DN	20
Water pressure	kPa	200-600
Capacity at 300 kPa	l/min	20
Drain valve	ø mm	50/75
Draining capacity	l/min	170
Steam valve	DN	15
Steam pressure	kPa	300-600
Liquid detergent supplies		5
Floor requirements		
Frequency of the dynamic force	Hz	20.8
Floor load at max extraction	kN	1.9 ± 0.5
Sound levels		
Sound power level (IEC 60704-2-4)		
wash	dB(A)	60
extraction	dB(A)	75
Heat emission		
% of installed power, max		5
Shipping data**		
Weight	net, kg	158
Shipping volume	m ³	0.81
Accessories		
Steel base		x
Hose kits for water or steam		x
Fluff collector		x
Dimensions in mm		
A Width		720
B Depth		1130
C Height		1132
D		408
E		721
F		831
G		80
H		1030
I		224
J		124
K		1010
L		910
M		278
N		98
O		239
1 Operating panel	7 Drain	
2 Door opening ø 310 mm	8 Liquid detergent supply	
3 Detergent box	9 Electrical connection	
4 Cold water	10 Steam connection	
5 Hot water		
6 Re-used water		

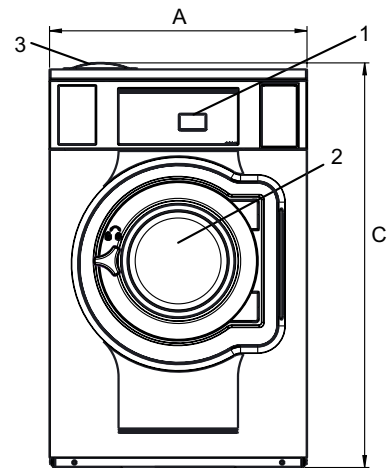

Front

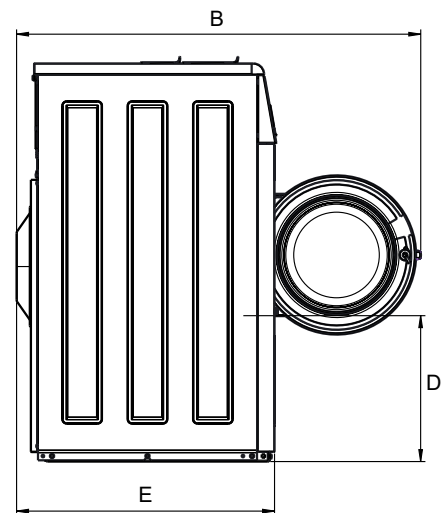

Side view

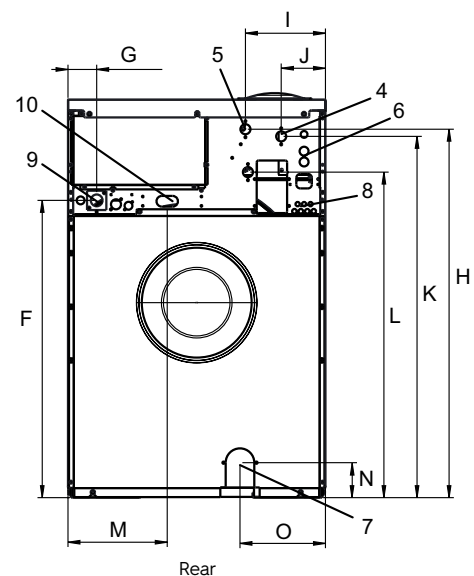

Rear

Front and side panels in light grey and blue (RAL 260 70 05, 250 60 30)

* Other voltages available, see installation manual.

** Average data. Crated weight/shipping volume depends on configuration. Please contact logistics for exact measures.